

# High-Precision Tuning Fork Electronic Balance

## S J – C E Series

### Operation Manual

#### **IMPORTANT**

- To ensure safe and proper use of the balance, please read this manual carefully.
- After reading this manual, store it in a safe place near the balance, so you can review it as needed.

SHINKO DENSHI CO., LTD.

# PREFACE

Thank you for purchasing an SJ-CE Series electronic balance. This is a precision instrument equipped with exacting mechanisms in a compact body. The SJ-CE Series provides enhanced functions, including a counting mode for stock control of parts, a percentage mode for comparative measurements given in percentages, and a limit function for measuring constant quantities by consecutive weighings. Despite its many functions, the balance is easy to operate and features user-friendly keys. Furthermore, the large liquid-crystal display provides excellent visibility, and the instrument's high speed and stability—intrinsic to a tuning fork design—help boost operational efficiency.

Before using the balance, please check that the following items have been included in the package.

Should you find any missing parts, please contact your local dealer.

(1) Main unit of balance

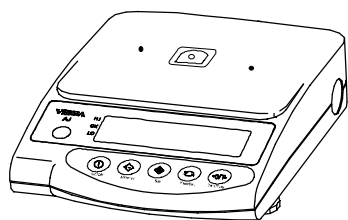

(2) Measurement pan  
(one round or square pan)



Round pan  
• SJ-220CE~620CE:  $\phi$  140mm

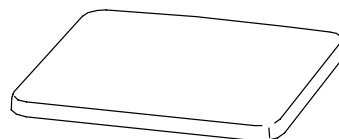

Square pan  
• SJ-1200CE: 170mm  $\times$  140mm  
• SJ-2200CE~12KCE: 180mm  $\times$  160mm

(3) Pan base

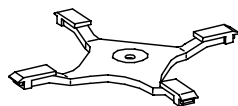

for Round pan



for Square pan

(4) AC adapter

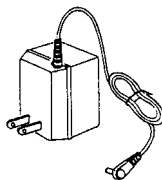

(5) Operation manual



# CONTENTS

---

<b>1. Precautions on the Use</b> .....	<b>2</b>	<b>8. Limit Function</b> .....	<b>22</b>
<b>2. Names of Component Parts</b> .....	<b>5</b>	8.1 Limit Function Setup.....	22
2.1 Main Unit .....	5	8.2 Setup of Limit Values by Actual Quantity Loads .....	24
2.2 LCD Indicators and Operating Keys .....	6	8.3 Setting up Limit Values by Inputting Values .....	25
<b>3. Basic Operations</b> .....	<b>8</b>	<b>9. Calibrating the Balance</b> .....	<b>27</b>
3.1 Installation .....	8	<b>10. Operating the Balance with the Battery</b> .....	<b>29</b>
3.2 Operation Check .....	9	<b>11. Troubleshooting</b> .....	<b>30</b>
3.3 Operation for Tare Subtraction.....	10	<b>12. Specifications</b> .....	<b>31</b>
<b>4. Functions</b> .....	<b>12</b>	12.1 Basic Specifications .....	31
4.1 Setup and Checking of Functions .	12	12.2 Common Specifications .....	31
4.2 Description of Functions.....	13	12.3 Capacities and Minimum Indications for Different Indication Units .....	32
4.3 Interface Section .....	14	<b>13. Conversion Table of Units</b> .....	<b>33</b>
<b>5. Switching Function for Units of Measurement</b> .....	<b>15</b>		
<b>6. Counting Pieces</b> .....	<b>17</b>		
6.1 Sampling .....	17		
6.2 Increasing the Counting Accuracy (Memory Update Method) .....	19		
<b>7. Measuring Percentage</b> .....	<b>20</b>		

# 1. Precautions on the Use

- This Section “Precautions Relating to Use” sets forth precautionary notes that the user should observe in order to prevent physical injury to the user and/or damage to property.
- The nature of problems that may result in the event of improper operation, and consequential effects on the quality and performance of the balance, are indicated under the two categories of “Caution” and “Recommended,” and explained using symbols.



**CAUTION**

This symbol indicates a risk of injury or property damage if the balance is used improperly. Be sure to observe these notes to ensure safe use of the balance as the improper use may cause serious results.

**RECOMMENDED**

This term indicates steps that the user should take to ensure the quality and reliability of the balance.

## Meanings of Symbols

Each symbol is accompanied by an instruction.



**Mandatory Symbol:**

Indicates a “mandatory” action that should be executed without fail.



**Check Level**



**Prohibitive Symbol:**









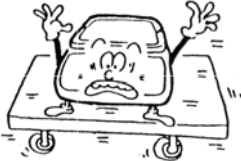

Indicates a “prohibited” action that must not be executed.





**Do not Use**





















		<p>※ <b>Do not disassemble or modify the unit.</b></p> <ul style="list-style-type: none"> <li>• Could cause malfunction or heat generation</li> <li>• Contact our local dealer.</li> </ul>
		<p>※ <b>Only AC power (rated value) should be used.</b></p> <p>※ <b>Only use the dedicated AC adapter.</b></p> <ul style="list-style-type: none"> <li>• Use of other types of power or adapters may result in heat generation or malfunction of the balance.</li> </ul>
		<p>※ <b>Do not move the balance when a sample is loaded.</b></p> <ul style="list-style-type: none"> <li>• The loaded sample may fall off the measurement pan and cause an injury.</li> </ul>

 <p><b>Do Not Use</b></p>		<p><b>Do not place the balance on an unstable base or use the balance in a location where it may be subjected to shock.</b></p>
 <p><b>Do Not Drop</b></p>		<p><b>Do not lay the AC adapter cable on the surface of the passage.</b></p> <ul style="list-style-type: none"> <li>• Somebody may trip on the cable, causing the balance to fall off, thereby causing injury and/or damage to the balance.</li> </ul>
 <p><b>Do not Handle with Wet Hands</b></p>		<p><b>Do not touch the AC adapter or balance with wet hands.</b></p> <ul style="list-style-type: none"> <li>• Danger of electric shock</li> </ul>
 <p><b>Keep Dry</b></p>		<p><b>Do not use the balance in a location where it may be subjected to excess moisture.</b></p> <p>Electric shock or short-circuiting could occur. The balance may be corroded, with resultant malfunction.</p>
 <p><b>Do Not Leave Afloat</b></p>		<p><b>Do not use the balance with its adjusters lifted.</b></p> <p>The balance will become unstable, preventing accurate measurement.</p>
 <p><b>Avoid Dust</b></p>		<p><b>Do not use the balance in a location where it may be subjected to excess dust.</b></p> <p>Risk of explosion or fire Short-circuit or lack of continuity may occur, leading to a malfunction of the balance.</p>

**RECOMMENDED**

 <p><b>Calibrate Balance</b></p>		<p><b>Calibrate the balance after installation or relocation.</b></p> <ul style="list-style-type: none"> <li>• Measurement values may contain errors, preventing accurate measurement from being conducted.</li> </ul>
---	---	--

 <b>Do Not Apply Force</b>		<b>Avoid applying excess force or impact to the balance.</b>
 <b>Do Not Use</b>		<b>Do not use the balance in a location where it may be subjected to abrupt changes in ambient temperature or humidity.</b> Accurate measurement may not be obtained. Optimum operations occur when ambient temperatures range from 10°C to 30°C, and less than 80% relative humidity.
 <b>Do Not Overload</b>		<b>Do not use the balance when [o-Err] (Overloaded) is displayed.</b> <ul style="list-style-type: none"> <li>Take down the loaded sample immediately to prevent breakage or malfunction.</li> </ul>
 <b>Do Not Use</b>		<b>Do not use the balance in a location where it is subject to direct sunlight.</b> The indications would be illegible. An internal temperature increase in the balance may lead to inaccurate measurement.
 <b>Unplug Adapter</b>		<b>If the balance is to be unused for an extended period of time, unplug the adapter.</b> This conserves power and prevents deterioration.
 <b>Do Not Use</b>		<b>Do not use volatile solvents for cleaning.</b> The body may be distorted. To clean the unit of stains, use a piece of dry cloth or cloth soaked in a small quantity of neutral detergent.
 <b>Do Not Use</b>		<b>Do not use the balance in a location where it may be subject to air from an air-conditioning unit.</b> <ul style="list-style-type: none"> <li>Extreme changes in the ambient temperature may result in inaccurate measurements.</li> </ul>
 <b>Do Not Use</b>		<b>Do not use the balance on a soft floor.</b> <ul style="list-style-type: none"> <li>When loaded with a sample, the balance may tip or move, preventing accurate measurements from being conducted.</li> </ul>
 <b>Check Level</b>		<b>Do not use the balance when it is tilted. An inclined balance is likely to produce errors, preventing accurate measurements from being conducted. Place the balance on a level surface.</b>

## 2. Names of Component Parts

### 2.1 Main Unit

Round-pan types (SJ-220CE, SJ-420CE, SJ-620CE)

Square-pan types ( SJ-1200CE, SJ-2200CE, SJ-4200CE, SJ-6200CE, SJ-12KCE)

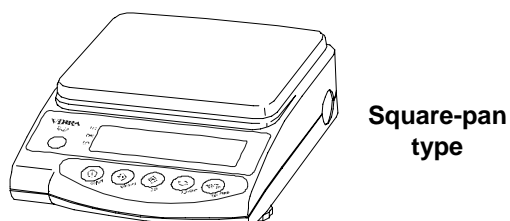
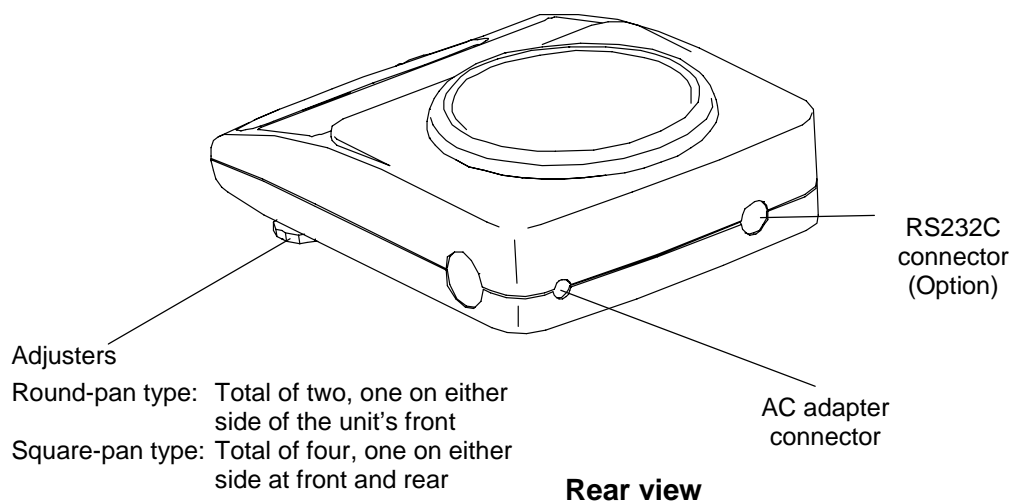
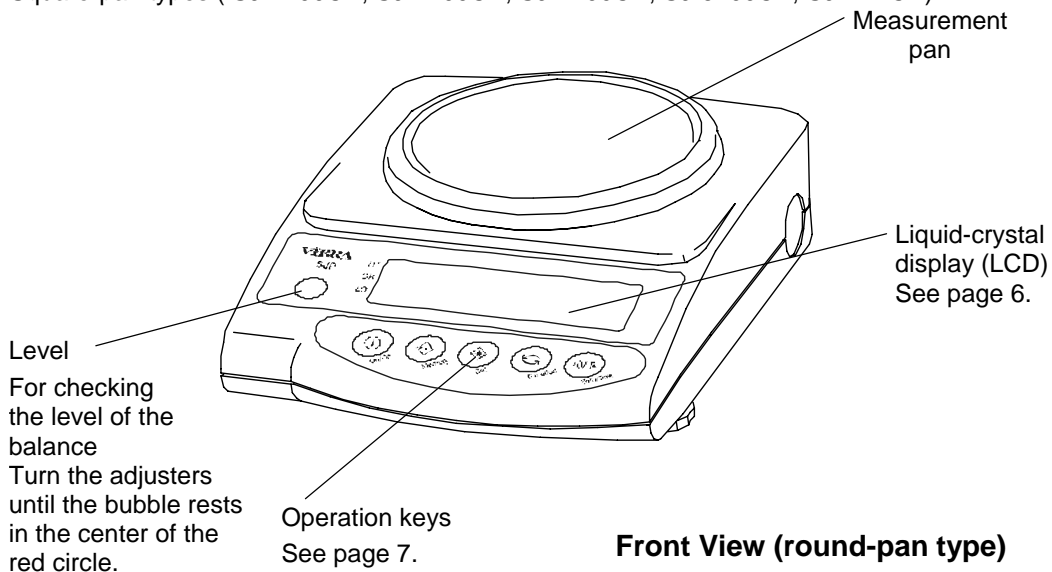

## 2.2 LCD Indicators and Operating Keys

### 2.2.1 Symbols Displayed

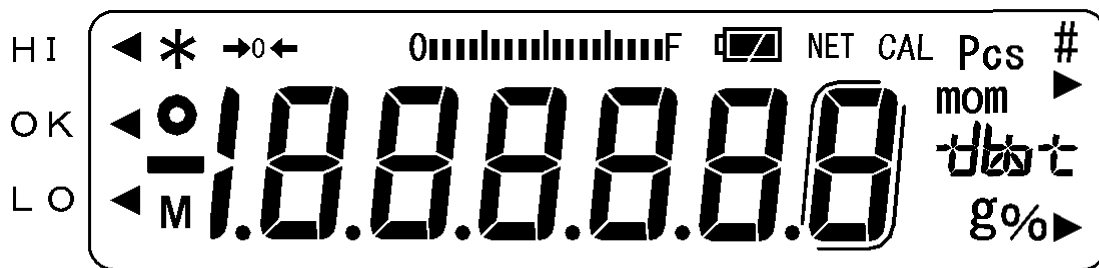

Display	Description
g	Grams
→0←	Zero point
NET	Tare being subtracted
○	Indication of stable balance (If the light is off, the balance is unstable.)
*	Balance powered up (Lights up when the power is turned off) or data transmitted
Pcs	Counting mode
%	Percentage mode
◀	Indication of judgement result (HI/OK/LO) when the limit function is active.
mom	Momme
M	Display of set values from memory (If a value is flashing, it is being saved.)
CAL	Stays on and flashes while span adjustment is in progress.
⎓	Auxiliary scale interval (Lights up only when the auxiliary scale interval is displayed.)※1
	Bar graph
 ※2	[ ct ] (ct) carat ※3
	[ oz ] (oz) ounce
	[ lb ] (lb) pound
	[ oz t ] (ozt) troy ounce
	[ dwt ] (dwt) penny weight
	[ t ] (t) tael (Hong Kong)
	[ t ▶ Upper right ] (t ▶ Upper right) tael (Singapore, Malaysia)
	[ t ▶ Lower right ] (t ▶ Lower right) tael (Taiwan)
[ to ] (to) tola	
	Lights up when the balance is battery-operated. The indication changes to  when the battery capacity decreases and charging is required. (See "10. Operating the Balance on the Battery" on page 29.)





※ ※The mark is on t1he displayed only in SJ-620CE & SJ-6200CE when the balance is sealed.

※2 Except [ct], these units are available only when the balance is not sealed.

※3 Not available in SJ-6200CE & SJ-12KCE



## 2.2.2 Names and Functions of Operating Keys



Operating Key		Function
	On/off key	Key to turn on/off the unit power
	Memory key	[Brief press] initiates print or output. [Brief press] saves the settings of the number of pieces or percentages (%), or the limit value when using the limit function.
	Set key	[Brief press] starts setting the number of pieces or percentages (%). [Continuous press] starts setting the limit value when using the limit function.
	Function key	[Brief press] toggle-switches the units to be displayed in succession (g, Pcs, %, etc.). [Brief press] moves the flashing digit in the setup of a limit value when using the value input method. [Brief press] selects an item when setting the function. [Continuous press] invokes various functions. [Longer continuous press] invokes span adjustment.
	Zero/Tare key	[Brief press] resets the indication to zero when using zero-point setup or tare subtraction. [Brief press] selects a value with the value input method when using the limit function. [Brief press] selects a function when operating the balance in the function mode.

## 3. Basic Operations

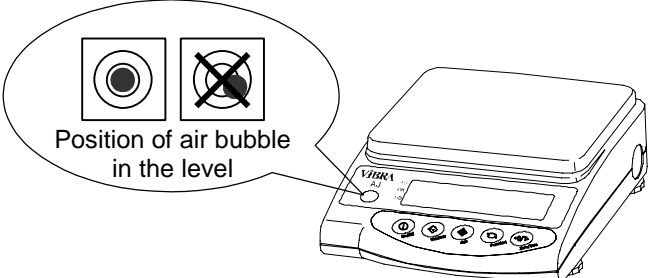
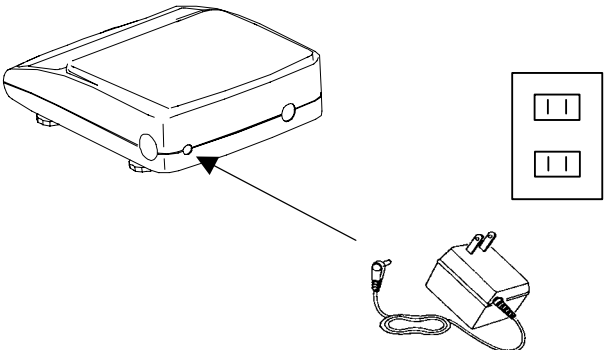

### 3.1 Installation

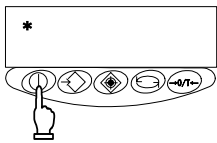
<p>1 Positioning the measurement pan</p> 	<p>First, mount the pan base on the main unit of the balance and place the measurement pan on top of it.</p>
<p>2 Securing the exact level of the balance</p>  <p>Position of air bubble in the level</p>	<p>Turn the adjusters until the bubble rests in the center of the circle on the level.</p> <p>&lt;Caution&gt; Use caution when operating the adjusters on the square-pan type to prevent them from lifting up.</p>
<p>3 Connecting the AC adapter</p> 	<p>Connect the AC adapter to the balance, as illustrated at left. ※Take 5 minutes before operation.</p> <p>&lt;Caution&gt; If the balance has the battery installed, refer to "10. Operating the Balance with the Battery," on page 29.</p>

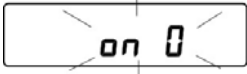
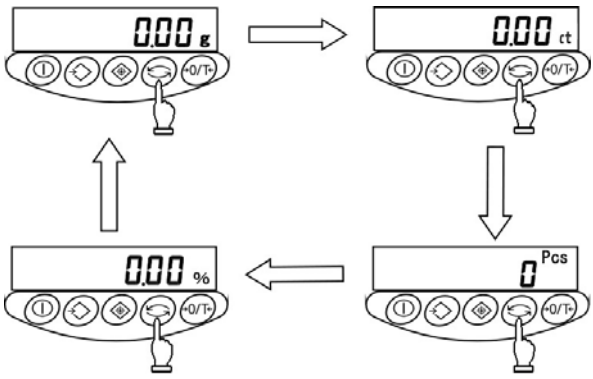
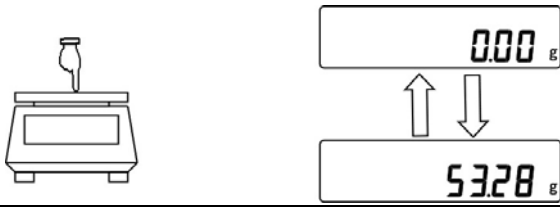
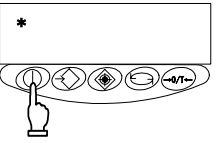

## 3.2 Operation Check

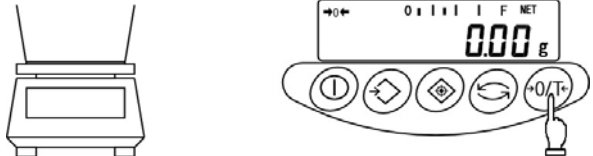
<p>1 Turning on the power</p>		<p>When the balance has the AC adapter connected, it displays [ * ]. Pressing the <b>On/Off</b> key The display section lights up, and the balance is ready for operation.</p>
<p>2 Checking the display</p>		<p>Check to see if the display has any missing indications or unlit parts. A few seconds after startup, the indication is reset to zero.</p>
<p>(When the balance is sealed)</p> 		<p>After every segment lights, [on 0] appears Adjust Zero point and Weight display appears. If something is loaded, the display does not change after [on 0] In this case, remove the load.</p>
<p>3 Switching the measurement mode</p> 	<p>Press the <b>Function</b> key. Each time the key is pressed, the unit of measurement changes, as indicated.</p> <p>※The balance is shipped from the factory with the following switching sequence: [g] → [ct] → [Pcs] → [%] → [g] → ...</p> <p>※ [ct] is not available for SJ-6200CE &amp; SJ-12KCE</p>	
<p>4 Verifying changes in the read-out indicator</p> 	<p>Press the measurement pan lightly and make sure that the read-out indicator changes. Also, ensure that the read-out indicator is reset to zero when you release your hand.</p>	
<p>5 Turn off the power</p>		<p>Press the On/Off key to turn off the power. Only the [*] mark in on the display.</p>

### 3.3 Operation for Tare Subtraction

<p>1 Place the tare (container) on the balance.</p> 	<p>As you place the tare, the balance indicates its weight.</p>
<p>2 Reset read-out indication to zero.</p> 	<p>Press the <b>Zero/Tare</b> key. The tare is subtracted and the balance indicates zero.</p>
<p>3 Load the sample to be weighed.</p> 	<p>The balance will now indicate only the weight of the sample loaded in the tare.</p>

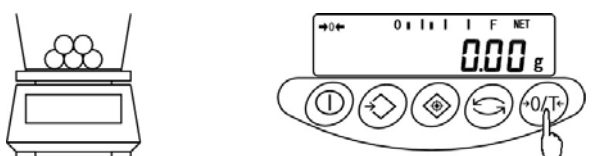
☆ Weighing only the weight of an added sample

<p>4 Resetting the indication to zero</p> 	<p>Press the <b>Zero/Tare</b> key. The total weight of the sample loaded on the measurement pan is indicated as zero.</p>
<p>5 Adding samples to be measured</p> 	<p>The balance indicates only the weight of an added sample.</p> <p>When the weight (of a sample) currently loaded on the measurement pan is reset to zero with the <b>Zero/Tare</b> key, as mentioned above, only the weight of the sample will be measured.</p>

## ★ Key Points of the Procedure ★

The following applies equally to all the measurement modes for weight measurement, counting, and percentages.

- After the balance is switched off, there is still enough current to display [ \* ]. This indicates that the AC adapter is connected to an electrical outlet, but that the balance is turned off. When the balance is switched on again, [ \* ] will disappear.
  - If the balance is running on batteries and the unit is switched off, the display does not display [ \* ].

- The bar graph shows the current load status with respect to the capacity of the balance. The nearer the [F] mark draws, the smaller the measurable weight becomes.

- Even when the display currently indicates zero with the tare subtracted, the weight corresponding to the subtracted tare is indicated on the bar.

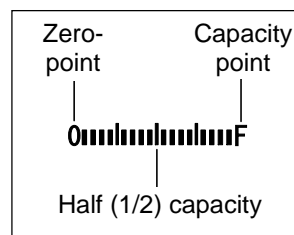

- When the balance remains stable, the stability indicator [O] remains on. If the balance becomes unstable, the stability indicator [O] will disappear. When a displayed value flickers or the stability mark flashes on and off, it is likely that the balance is being affected by wind or other vibrations. Use the windshield or vibration dampers to protect against such adverse effects.

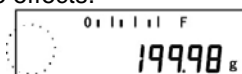

Unstable

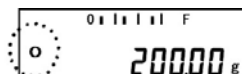

Stable

- When the read-out indicator is reset to zero or the tare is subtracted, the balance indicates zero this way: [→ 0 ←]. If the tare is subtracted, the indicator reads as follows: [NET].

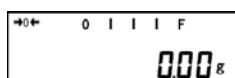

\*If the indication deviates from the true zero point by 1/4 of a graduation or less, [→0←] disappears.



\*If the tare is subtracted, the balance indicates zero, and [NET] lights up.

- When the tare is subtracted, the measurable range is reduced.  
Measurable Range = Capacity - Tare Weight
- If [o-Err] appears when a sample is loaded, the measurable range has been exceeded.
- In counting mode or percentage mode, if no sample is stored in memory the indicator will not change, even when the measurement pan is pressed.
- The measurement mode that is activated when the balance is switched on will be the one that was active when last switched off. For example, if the balance was switched off in counting mode, this counting mode will be reactivated the next time the balance is switched on.
- To print data on the balance, set "Output Control (71.o.c.)" to [2], [4], [5], or [7], so that only stable data will be printed (see "4.3 Interface Section" on page 14).

## 4. Functions

### 4.1 Setup and Checking of Functions

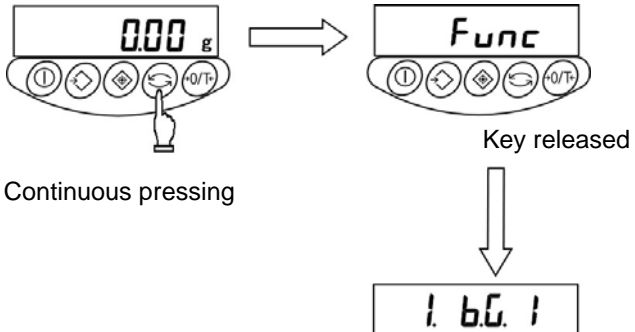
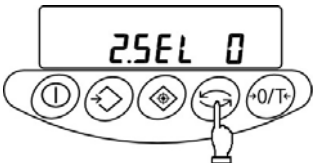
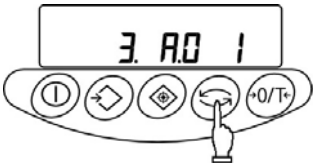
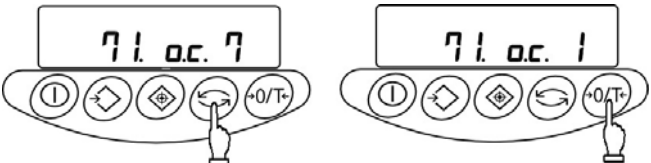
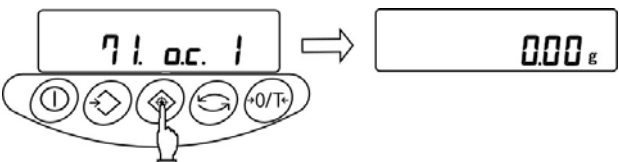
<p>1 Invoking the function</p> 	<p>Press and hold down the <b>Function</b> key until the indicator changes to “Func,” then release the key.</p> <p>The function setup mode is activated, and the first item, [1. b.G. 1 (Bar graph) ] appears. (See “4.2 Description of Functions” on page 13.)</p>
<p>2 Selecting the next item</p> 	<p>Press the <b>Function</b> key.</p> <p>The indication changes to the next item, [2.SEL 0 (Limit function)].</p>
<p>3 Selecting an item</p> 	<p>Pressing the <b>Function</b> key advances the function items at the rate of one item per press.</p>
<p>4 Changing the content of an item</p> 	<p>Select the item to be changed with the <b>Function</b> key.</p> <p>Each press of the <b>Zero/Tare</b> key changes the digit on the right end. Select the desired one.</p>
<p>5 Terminating the function selection</p> 	<p>Press the <b>Set</b> key.</p> <p>The balance terminates the function setup and returns to measurement mode.</p>

## 4.2 Description of Functions

Item		Set Value	Description		
Bar graph display		1. b.G.	0 Disable ----- ☆1 Enable		
		Limit function		2. SEL ----- ☆0 Disable ----- 1 Enable	
Displayed only when limit function is activated	Judgement condition	21.Co.	----- ☆1 Always judge (judges even when the balance is unstable) ----- 2 Judge only when the balance is stable (does not judge if the balance is unstable)		
	Judgement range	22.Li.	----- 0 Ranges beyond +5 graduation is judged (ranges +5 graduation or below, including negative ranges, are not judged.) ----- ☆1 The entire range is judged (the entire range, including the negative, is judged).		
	Number of points for judgement	23.Pi.	----- 1 One-point setup (judges between OK and LO) ----- ☆2 Upper-limit and lower-limit values are set up (judges among HI, OK and LO).		
Auto-zero (zero-tracking)		3. A.0	----- 0 Disable ----- ☆1 Enable ----- This function automatically sets the zero point exactly to zero to prevent slight deviations.		
Auto power-off		4. A.P.	----- 0 Disable (balance operates continuously) ----- ☆1 Enable (balance powers off in approximately three minutes) ----- This function is available only when the balance is battery-operated.		
Response speed		5. rE.	----- 0 Measurement by consecutive weighings. ----- 1 ----- 2 Fast ----- ☆3 ↓ ----- 4 Slow ----- 5		
		Stability parameters		6. S.d. ----- 1 ----- ☆2 Wide (mild) ----- 3 ↓ ----- 4 Narrow (strict)	
		Interface		7. I.F. ※1	----- 0 Disable input/output ----- ☆1 Six-digit numeric format ----- 2 Seven-digit numeric format
		Setup of units of measurement to be displayed  Register selected measuring units with <span style="border: 1px solid black; padding: 2px;">Function</span> key.		81.S.u.	----- ☆1 01 [ g ] ----- ☆2 14 [ <b>ct</b> ] (ct) ※3 ----- 15 [ <b>oz</b> ] (oz) ----- 16 [ <b>lb</b> ] (lb) ----- 17 [ <b>oz t</b> ] (ozt) ----- 18 [ <b>dwt</b> ] (dwt)
				85.S.u. ※2	1A [ <b>tl</b> ] (tl_Hong Kong)
1b [ <b>tl</b> ▶ ] Upper right] (tl_Singapore, Malaysia)					
1C [ <b>tl</b> ▶ ] Lower right] (tl_Taiwan)					
1d [mom]					
1E [ <b>to</b> ] (to)					
Items marked ☆ are the default factory settings. ☆1-☆5: default settings [81.S.u.]-[85.S.u.]					

Setup of units of measurement to be displayed	81.S.u.   85.S.u.	☆3 20	[Pcs]
		☆4 1F	[%]
		☆5 00	Unit not set
Display of the auxiliary scale interval	9. Ai ※4	0	Disable
		☆1	Enable ( <input type="checkbox"/> is the auxiliary scale interval.) Note: The auxiliary-scale-interval place does not represent a verification scale interval. Use it only as a reference value.
Output format while the auxiliary scale interval is displayed	A.PrF. ※5	1	No output is made while the auxiliary scale interval is displayed.
		2	Output is made even while the auxiliary scale interval is displayed.
		☆3	Output is made with “/” added to the left of the auxiliary-scale-interval place.

※1 Setting is effective only when optional RS232C is used.

※2 Can be set only for a model on which the balance is not sealed. For a model on which the balance is sealed, only the units set when the balance was unsealed are effective. ☆1-☆5: default factory settings [81.S.u.]-[85.S.u.]

※3 Not available in SJ-6200CE and SJ-12KCE.

※4 Applicable only in SJ-620CE & SJ-6200CE

※5 Displayed only in SJ-620CE & SJ-6200CE, when unsealed.

### 4.3 Interface Section

Displayed when [7. I.F. [ ]] is set to [1] or [2]

Item	Set Value	Description	
Output Control	71.o.c.	0	Stop output
		1	Output continuous at all times
		2	Output continuous if stable (stop output if unstable)
		3	Outputs once by pressing [Memory] key (irrespective of whether stable).
		4	Outputs once if stable. Outputs if the balance is stable when a sample is loaded after the preceding sample has been removed and the balance indicated zero, or less.
		5	Outputs once if stable, and stops output when unstable. Even if the sample is not replaced, the balance is output once when it stabilizes next time (including the zero indication).
		6	Outputs once if stable, and outputs continuously when unstable. Even if the sample is not replaced, output of the balance stops when it stabilizes after being output once.
Baud Rate	72.b.L.	☆1	1200 bps
		2	2400 bps
		3	4800 bps
		4	9600 bps
		☆7	Pressing [Memory] key causes the balance to output once when stable.
Parity	73. PA.	☆0	None
		1	Odd
		2	Even

☆ denotes a factory-setting

※The data interval in continuous output mode is 0.1 to 1 second. (The interval varies depending on weighting conditions and other factors.)



## 5. Switching Function for Units of Measurement

Pressing the **Function** key allows the user to switch the unit of measurement to [g], [ct], [%], and so on.

Up to five different units can be registered for use only when the function key is properly set on a balance for which the balance is not sealed.

### 5.1 Switching Units of Measurement

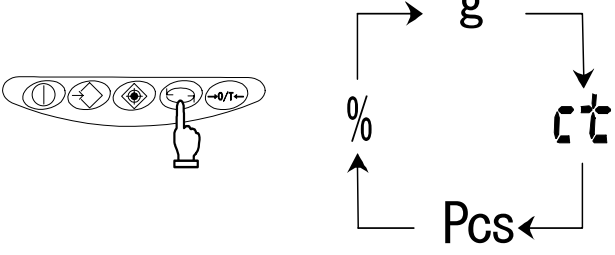
<p>Switching the units of measurement to be displayed</p> 	<p>Press the <b>Function</b> key. Each press advances through the units of measurement to be displayed.</p> <p>※1 The balance is shipped from the factory with the following default setup: [g] → [ct] → [Pcs] → [%] → [g] → ...</p> <p>※2 [ct] is not available in SJ-6200CE &amp; SJ-12KCE.</p>
---	---

### 5.2 Setup of Units of Measurement (Only when the balance is not sealed)

When values [81.S.u.] to [85.S.u.] are entered prior to use, the desired unit of measurement to be displayed can be chosen simply by pressing the **Function** key. For more information on the units of measurement that can be set here, please refer to “4.2 Description of Functions” on page 13.

**Example: To change the default factory settings to pound units, use [82.S.u.] in the factory settings.**

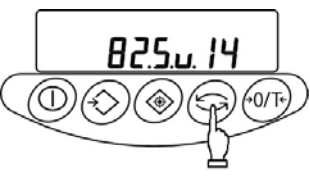
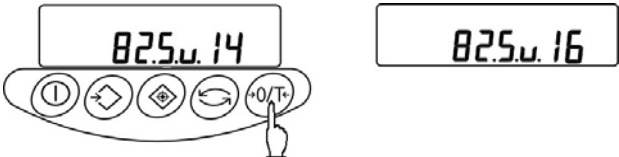
<p>1 Display the function item [82.S.u.14]</p> 	<p>Press and hold down the <b>Function</b> key. Release the key as [Func] appears on the display. The function setup mode is now activated and the first item is displayed. Press the <b>Function</b> key several more times, until [82.S.u.14] appears.</p>
<p>2 Setting the unit to a pound</p> 	<p>Press the <b>Zero/Tare</b> key several times to specify [82.S.u.16].</p>

**Example: To change the default factory settings to pound units use [82.S.u.] in the factory settings. (cont.)**

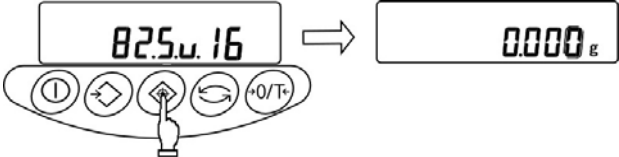
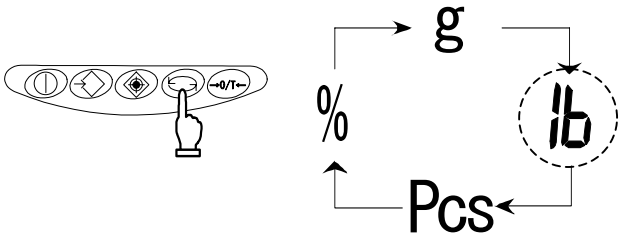
<p>3 Pressing the [Set] key to restore measurement mode.</p> 	<p>Pressing the <b>Set</b> key will reset the measurement mode</p>
<p>4 Pressing the [Function] key to change the units of measurement</p> 	<p>Press the <b>Function</b> key. Each press of the key changes the units of measurement to be displayed, as follows: [g] → [lb] → [Pcs] → [%] → [g] → ...</p>

**★ Key Points of the Procedure ★**

1. When set values are entered in the function items [81.S.u.] to [85.S.u.] prior to use, the desired unit of measurement to be displayed can be selected simply pressing the **Function** key. For more information on the units of measurement that can be set, please refer to “4.2 Description of Functions,” on page 13.
2. The units are displayed in the same sequence as the settings made from [81.S.u.] to [85.S.u.].
3. If [00] is set, no unit of measurement will be displayed, even when units of measurement are set in subsequent items.
4. [00] cannot be set in [81.S.u.].
5. If the same unit of measurement is set multiple times, the second time (and all subsequent times) the unit(s) occurs, it will be ignored when the display switches.
6. The units can be set only on the balance is not sealed.
7. When units other than [g] or [ct] is selected and the power is turned off, [g] is automatically selected the next time the power is turned on. ( under the balance is sealed.)

## 6. Counting Pieces

To implement piece-counting, the specified samples are loaded on the balance, and their average unit weight (hereinafter, simply the “unit weight”) is entered and saved. The procedure for saving unit weights is called sampling.

The counting procedure consists of loading articles that have already been sampled on to the balance. The number of pieces is then calculated by dividing the total weight of the loaded articles by the unit weight saved in memory. Piece counting cannot be implemented unless sampling has already taken place.

Sampling

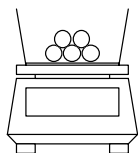

$$\frac{\text{Weight}}{\text{Number of samples}} = \frac{10 \text{ g}}{10 \text{ pieces}} = 1 \text{ g}$$

= Sample unit weight

Counting Pieces

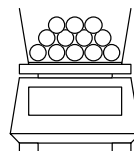



$$\frac{\text{Total weight}}{\text{Sample unit weight}} = \frac{500 \text{ g}}{1 \text{ g}} = 500 \text{ pcs.}$$

= Measured number of samples

※If samples to be counted deviate widely in weight, or a higher measure of accuracy is desired, it is recommended that users use the “Raising the Counting Accuracy” method. This procedure results in greater precision by increasing the number of samples used in the sampling operation.

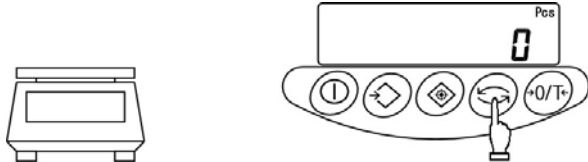
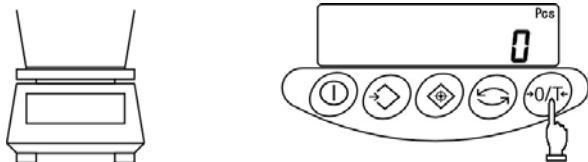
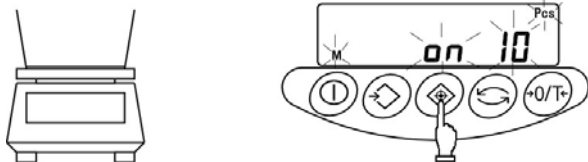
### 6.1 Sampling

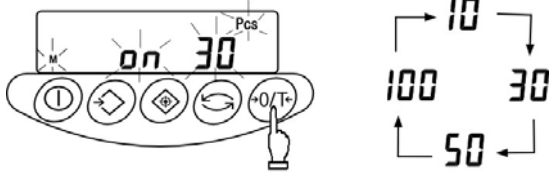
<p>1 Activating the counting mode</p> 	<p>Press the <b>Function</b> key to display [Pcs].</p>
<p>2 Resetting the indication to zero</p> 	<p>Place the tare and press the <b>Zero/Tare</b> key. The tare is subtracted and the balance now indicates zero.</p>
<p>3 Starting the sampling</p> 	<p>Press the <b>Set</b> key. The display flashes a number, such as [on 10]. This means that ten samples are to be loaded. The sampling number that was used in the previous sampling will be displayed here.</p>

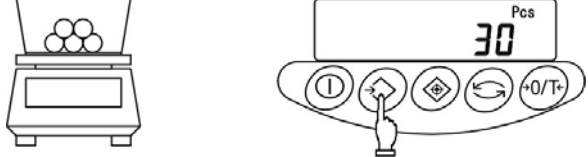
<p>4 Changing the sampling number, if necessary.</p> 	<p>If samples to be counted widely deviate in weight, or a higher measure of accuracy is desired, it is recommended that users change the sampling number to a larger value.</p> <p>Press the <b>Zero/Tare</b> key.</p> <p>Each press of the key changes the value on the right end. Select the desired value. If the sampling number need not be changed, go on to the next step.</p>
<p>5 Loading samples</p> 	<p>Load the number of samples displayed. Count the samples precisely and load them in the center of the measurement pan.</p>
<p>6 Saving the unit weight of samples</p> 	<p>Press the <b>Memory</b> key.</p> <p>The balance saves the unit weight and reverts to measurement mode.</p>



## ★ Key Points of the Procedure ★

1. While the samples are being saved, the value indication disappears and only [M] flashes to indicate that memory saving is underway. If the balance is affected by wind or other vibrations during this process, the saving time may be prolonged.
2. If [L-Err] appears, it indicates one of the following states:
  - (1) The weight of one sample (measurable unit weight) is insufficient. For the range of unit weights that can be measured and saved, please refer to "11. Specifications," on page 30.
  - (2) In the sampling of Operation Step 3, press the **Set** key with the samples loaded on the balance.

※If [L-Err] appears, the sampling is interrupted and the data in progress is not saved.
3. The operation for increasing counting accuracy is referred to as the Memory Update Method. This procedure updates the memory with a unit weight that represents a more precise average by gradually increasing the sampling number. This operation improves counting accuracy and is recommended for the following cases;
  - (1) When the samples to be counted deviate widely in weight or the number of samples displayed deviates.
  - (2) When greater accuracy is desired.
4. If [Add] appears in Memory Update Method, it indicates that a counting error is likely due to the small number of the samples loaded on the balance. [◀] will light up at the judgment indication "LO." As the memory update continues, counting accuracy improves and the above indication disappears.
5. If you change the sampling number, subsequent sampling will start from the new sampling number.



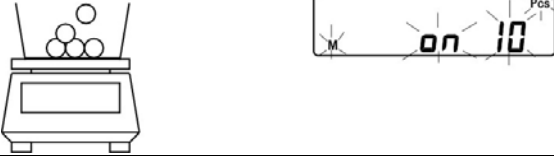
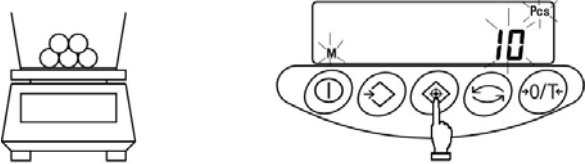

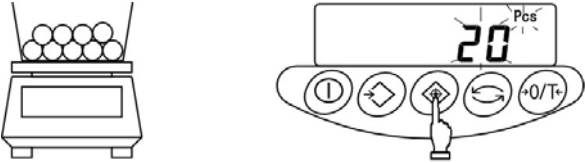
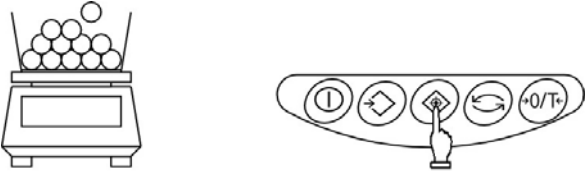
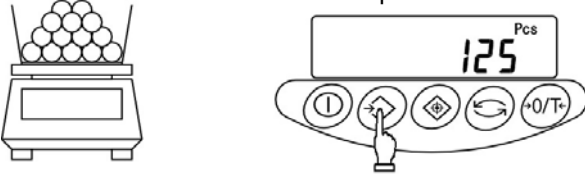
## 6.2 Increasing the Counting Accuracy (Memory Update Method)

※This procedure is the same as the sampling procedure described on the previous page up, to the point at which the sampling number is changed.

<p>1 Loading samples</p> 	<p>Load the number of samples displayed. Count the samples precisely and load them on to the center of the measurement pan.</p>
<p>2 Saving the samples</p> 	<p>Press the <b>Set</b> key. The unit weight of the samples is saved, and the display changes to a flashing value. This flashing value denotes that the Memory Update Method is currently active.</p>
<p>3 Adding samples</p> 	<p>Add approximately an equal number of samples as the number currently displayed. Add them gradually, in groups of approximately the same number, until the number of samples is approximately double. The additional samples need not be counted.</p>
<p>4 Saving the samples</p> 	<p>Press the <b>Set</b> key. After the unit weight of the samples has been saved, the display begins to flash, indicating that the Memory Update Method is still running.</p>
<p>5 Repeating the addition and saving of samples</p> 	<p>Repeat steps 3 and 4. The eventual total number of samples to be saved should be approximately 1/5 to 1/2 of the number of samples to be measured.</p>
<p>6 Terminating the sampling</p> 	<p>Press the <b>Memory</b> key. The balance saves the unit weight and returns you to measurement mode.</p>

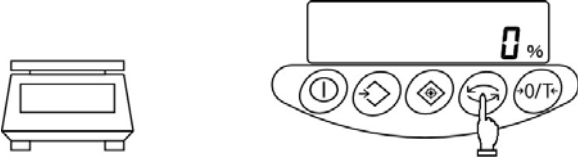
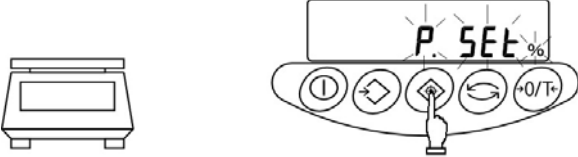
## 7. Measuring Percentage

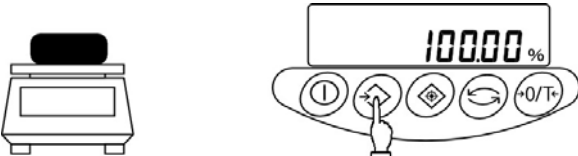
The percentage measurement function operates by weighing an actual sample, selected as the reference, and saving its weight as the reference value and indexing it as 100%. When a measurement sample loaded on the balance is lighter or heavier than the reference, its weight is indicated as a percentage (%) value relative to the reference weight.

<p>1 Activating the percentage mode</p> 	<p>Press the <b>Function</b> key to display [%].</p>
<p>2 Setting the reference value</p> 	<p>Press the <b>Set</b> key. The display begins flashing [P. SEt]. The balance is now ready for reference value setup.</p>
<p>3 Loading the sample</p> 	<p>Load the reference sample.</p>
<p>4 Saving the reference value</p> 	<p>Press the <b>Memory</b> key. The balance indexes the weight value of the reference sample as 100% and returns you to measurement mode.</p>
<p>5 Loading a sample to be measured</p> 	<p>The balance now indicates the weight of the loaded sample as a percentage (%) value relative to the reference value.</p>

## ★Key Points of the Procedure ★

1. While samples are being saved, the value indication disappears temporarily, and only the [M] mark flashes. If the balance is affected by wind or other vibrations during this process, the saving time may be prolonged.
2. If [L-Err] appears briefly, it indicates one of the following states:
  - (1) The weight of the reference sample is insufficient.  
For the limit weight that can be saved (% limit weight), please refer to “11. Specifications,” on page 30.
  - (2) While setting up the reference value in Step 2, the Set key has been pressed while the samples were loaded on the balance.

※If [L-Err] appears, sampling has been interrupted and the sample value being processed will not be saved.
3. The minimum intervals between percentages in the unit switch from 1%, to 0.1%, to 0.01%, depending on the reference weight from the sampling.

## 8. Limit Function

The limit function judges measurements according to a limit value saved in the balance.

The function shows the judgement result by displaying the [◀] mark as either HI (excessive), OK (appropriate), or LO (insufficient). This function is very useful when discriminating between conforming and nonconforming articles. It is also useful when measuring a given constant quantity consecutively, in conjunction with a range of reference weights defined by upper- and lower-limit values.

This function can be used in weight mode, counting mode, or percentage mode.

### Limit value input methods

Either of the following two methods can be used in the different modes:

- (1) Actual quantity setup method ..... An actual sample is loaded on the balance and its weight saved as the limit value.
- (2) Numeric value setup method ..... The limit value is entered with a key stroke.

※The limit values entered are held in memory, even when the balance is powered down.

※The respective limit values for weight mode, counting mode, and percentage mode are set up independently.

### Indication of judgement result

The [◀] mark lights up as either HI, OK, or LO on the left side of the display, indicating the result of judgement.

Judgement Results	Upper/lower-limit setting	One-point setting
HI (excessive)	Upper-limit value < measurement value	No indication
OK (appropriate)	Upper-limit value ≥ measurement value value ≥ lower-limit value	Limit value ≤ measurement value
LO (insufficient)	Lower-limit value > Measurement value	Limit value > Measurement value

### 8.1 Limit Function Setup

1 Invoking the function

Continuous pressing



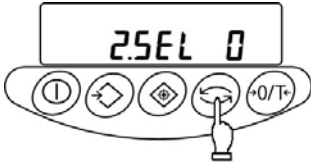
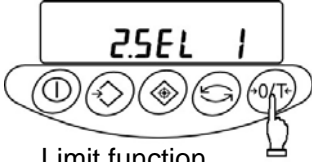
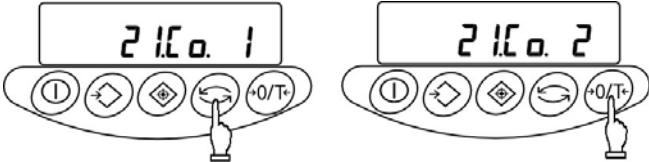
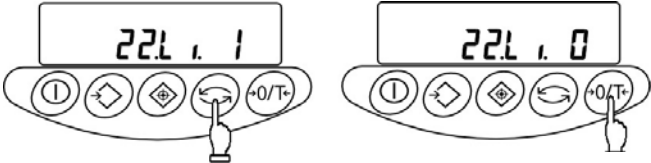
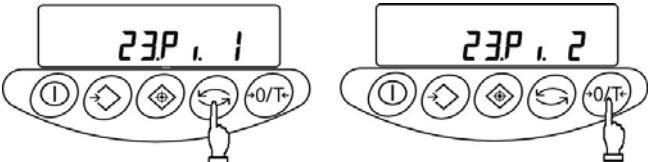
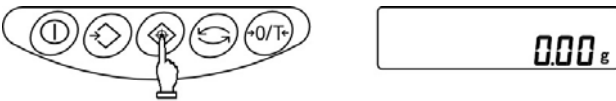

Key released

Press and hold down the Function key.  
Release the key when [Func] is displayed.  
The display changes to the function setup and the first item is displayed.



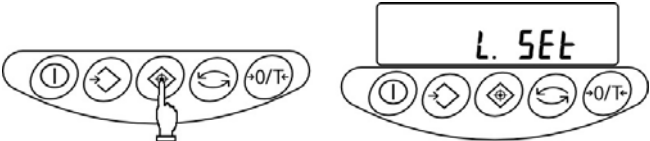

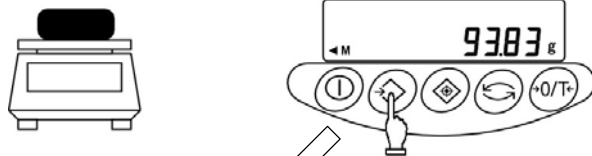
<p>2 Selecting a function item</p> 	<p>Press the <b>Function</b> key. The display changes to the next item [Limit Function].</p>
<p>3 Setting the limit function</p>  <p>Limit function operations</p>	<p>Press the <b>Zero/Tare</b> key to set the value on the rightmost side to [1].</p>
<p>4 Setting the judgement condition</p>  <p>Judged at all times      Judged when stable</p>	<p>Press the <b>Function</b> key. The display changes to [Judgement Condition]. Press the <b>Zero/Tare</b> key to select the desired condition.</p>
<p>5 Setting the judgement range</p>  <p>Judge entire range      Judge beyond +5</p>	<p>Press the <b>Function</b> key. The display changes to [Judgement Range]. Press the <b>Zero/Tare</b> key to select the desired choice.</p>
<p>6 Setting the number of judgement points</p>  <p>One point set      Upper/lower limits set</p>	<p>Press the <b>Function</b> key. The display changes to [Judgement Points]. Press the <b>Zero/Tare</b> key to select the desired choice.</p>
<p>7 Terminating the function setup</p> 	<p>Press the <b>Set</b> key. The balance terminates the function setup and returns you to measurement mode.</p>

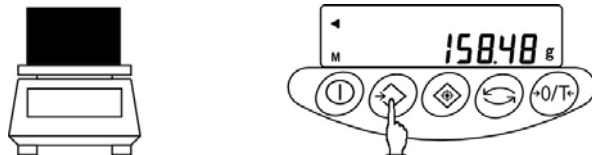
## 8.2 Setup of Limit Values by Actual Quantity Loads

<p>1 Starting the limit function</p>  <p>Continuous pressing                      Key released</p>	<p>Press and hold down the <b>Set</b> key. Release the key when [L. SEt] is displayed. The currently set lower-limit value flashes.</p>
<p>2 Loading the sample for the lower-limit value</p> 	<p>Load the sample of the lower-limit value on the measurement pan.</p>
<p>3 Saving the lower-limit value</p> 	<p>Press the <b>Memory</b> key. After the lower-limit value has been saved, the balance displays it briefly and proceeds to the following setup. ※If One-point setup was chosen, the setup is complete.</p>
<p>4 The upper-limit value setup</p> 	<p>The display now changes to [H. SEt], indicating that the upper-limit value can be set. The currently set upper-limit value flashes.</p>
<p>5 Loading the sample of the upper-limit value</p> 	<p>Load the sample of the upper-limit value on the measurement pan.</p>
<p>6 Saving the upper-limit value</p> 	<p>Press the <b>Memory</b> key. After saving the upper-limit value, the balance displays it briefly and terminates the setup.</p>

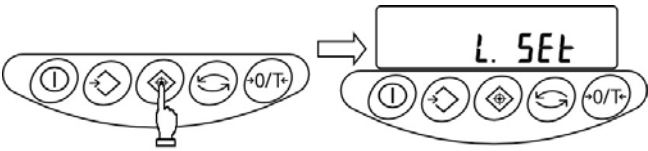
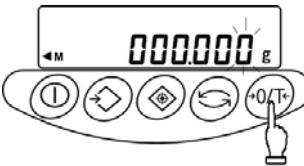
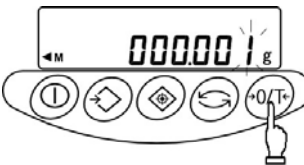
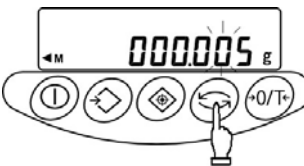
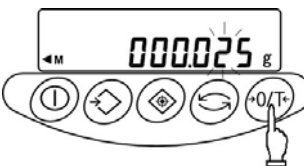
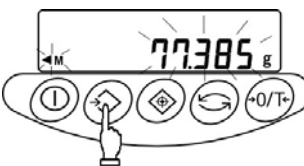
### 8.3 Setting up Limit Values by Inputting Values

<p>1 Starting the limit function</p>  <p>Continuous pressing                      Key released</p>	<p>Press and hold down the <b>Set</b> key. Release the key when [L. SEt] is displayed. The currently set lower-limit value flashes.</p>
<p>2 Opening the value input screen</p> 	<p>Press the <b>Zero/Tare</b> key. All the digits are displayed, with the one on the right end flashing. This flashing digit is the one that can be changed.</p>
<p>3 Entering a value</p> 	<p>Press the <b>Zero/Tare</b> key again. Pressing the key repeatedly changes the flashing value until the desired number is entered.</p>
<p>4 Selecting a digit</p> 	<p>Press the <b>Function</b> key. The flashing moves to the digit on the immediate left. Each time the key is pressed, the flashing digit moves one position left. When the leftmost digit is selected, the flashing advances to the rightmost digit position.</p>
<p>5 Repeat Steps 3 and 4</p> 	<p>Enter the lower-limit value by selecting a value with the <b>Zero/Tare</b> key and moving the digits with the <b>Function</b> key, as needed.</p>
<p>6 Saving the lower-limit value</p> 	<p>Press the <b>Memory</b> key. After saving the lower-limit value, the balance displays it briefly and proceeds to the next setup. ※If one-point setup was chosen, the setup is complete.</p>
<p>7 Setting up the upper-limit value</p> 	<p>The display changes to [H. SEt], indicating that the upper-limit value can be set. If there is an upper-limit value already set, that value will flash.</p>

## Setting up Limit Values by Inputting Values (cont.)

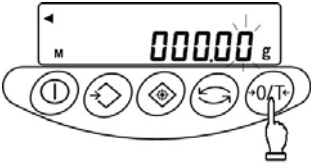
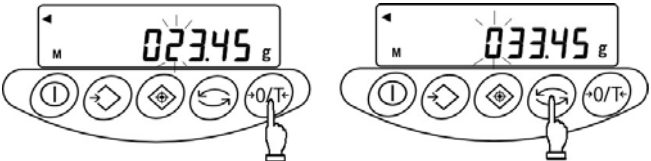
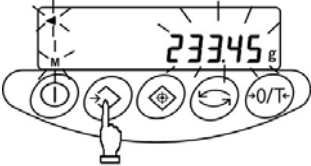
<p>8 Opening the value input screen</p> 	<p>Press the <b>Zero/Tare</b> key. Follow the same procedure as in “Step 2.”</p>
<p>9 Setting the upper-limit value</p> 	<p>Follow the same procedure as described for the lower-limit value and enter the upper-limit value.</p>
<p>10 Saving the upper-limit value</p> 	<p>Press the <b>Memory</b> key. After saving the upper-limit value, the balance displays it briefly and terminates setup.</p>

## ★ Key Points of the Procedure ★

- The limit values you have set can be checked each time you press the **Set** key. The balance displays the lower-limit value after showing [L. SEt], and the upper-limit value after showing [H. SEt].

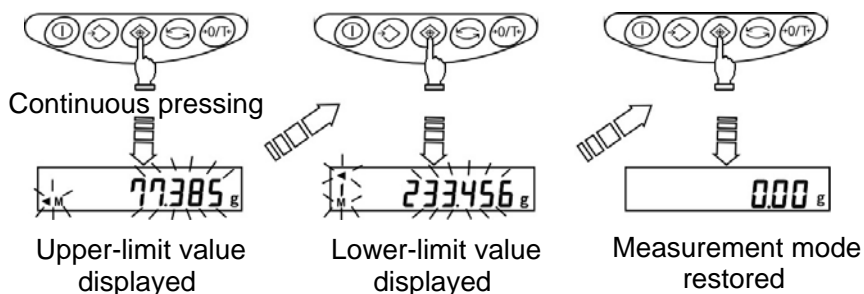

- If you make a mistake, press the **Function** key during the setup of actual quantities or the **Set** key during the setup of values.
- If you press the **Memory** key while a value is flashing, an actual quantity will be set based on the weight currently loaded on the balance. Pressing the **Zero/Tare** key at this time displays the value input screen.
- If the **[<]** mark lights up for all three judgement indicators, HI, OK, and LO, the lower-limit value set exceeds the upper-limit value. Check the values, since mistakes can occur with entries, as in cases when the upper-limit value is specified with a negative sign.
- When the **[M]** mark is flashing on the value input screen, the sign on the left end can be changed. Press the **Zero/Tare** key to switch between the positive and negative signs.

## 9. Calibrating the Balance

※ Calibration is possible only when the balance is unsealed.

Since electronic balances are affected by gravity gravitational acceleration, they produce different values in various locations. Therefore, before use, balances must be calibrated at the location where they are installed. Calibration is also required after long periods without use, or if a balance begins produce inaccurate values.

Calibration of a balance, or “span adjustment,” is required to produce accurate measurements.

- Span adjustment should be performed with the balance installed perfectly level and without any load on the measurement pan.

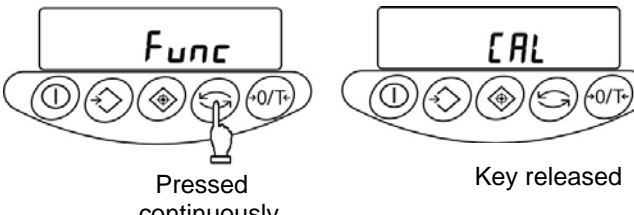
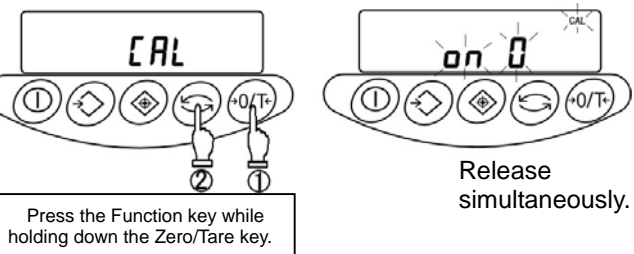
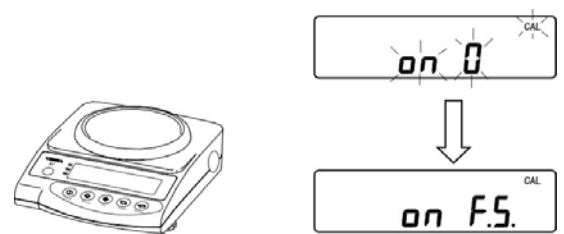
<p>1 Activating the span adjustment function</p> 	<p>Press and hold down the <b>Function</b> key. Release the key when the display changes from [Func] to [CAL].</p>
<p>2 Starting the span adjustment</p> 	<p>Press the <b>Function</b> key while holding down the <b>Zero/Tare</b> key, then release both keys simultaneously. The display flashes [on 0], indicating that zero-point calibration is underway.</p>
<p>3 Zero calibration</p> 	<p>Zero-point calibration is finished when the display changes to [on F.S.]. Proceed to the calibration of the capacity point.</p>

## Calibrating the Balance (cont.)

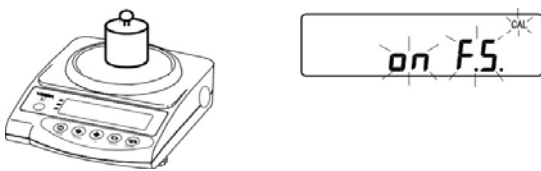
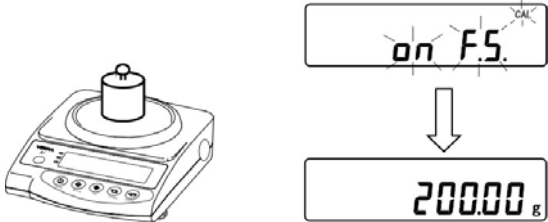
<p>4 Calibrating the capacity point</p> 	<p>Load the calibration weight in the center of the balance. The display flashes, indicating that capacity point calibration is in progress.</p>
<p>5 Terminating the span adjustment</p> 	<p>When the calibration of the capacity point is finished, the original measurement mode is restored.</p>

### ★ Key Points of the Procedure ★

1. Pressing the Function key in Step 2 interrupts the span adjustment and returns you to the original measurement mode.
2. The calibration weight used for span adjustment should be heavier than 50% of the capacity of the balance.  
To implement a calibration as precisely as possible, use a weight close to the capacity of the balance.  
※Calibration weights can be purchased from us. For detail information, please contact our local dealer.
3. If problems arise during span adjustments, one or more of the following error messages will appear:
  - (1) [o-Err]: The calibration weight exceeds the capacity of the balance.
  - (2) [1-Err]: The calibration weight is less than 50% the capacity of the balance.
  - (3) [2-Err]: The difference between before and after calibration values is too large (1.0% or more).

※If error messages are displayed, calibration cannot take place.  
Check the weight and re-calibrate. If the same error continues after repeated calibrations using the correct weight, please contact our local dealer.

## 10. Operating the Balance with the Battery



---

This function can be used only when the balance is battery-operated.

### 10.1 Specifications



- Built-in nickel-cadmium battery
- Charging time: Approximately 12 hours
- Drive time: Approximately 32 continuous hours
- Number of charge/discharge cycles: 300 or more

### 10.2 Charging Method

• While the balance is battery-operated, [  ] stays on. The indicator flashes [  ] (charging required) when battery capacity decreases. If the balance flashes [  ], charge the battery by following these steps:

- (1) Connect the dedicated AC adapter to the balance.
- (2) Turn the balance off.
- (3) Charging takes approximately 12 hours, with power switched off.

### 10.3 User Precautions

1. Once charging is complete, use the balance without the AC adapter to avoid over-charging. This can occur since the balance continues to charge the battery with a weak current when the power is switched on. Overcharging will also decrease battery life.
2. When the balance is used for the first time after purchase, the operating time may be shorter than when using a fully charged battery. This is due to natural discharge of the battery. Although the balance can be used while [  ] is flashing, it should be recharged as soon as possible.
3. When the battery displays no indication, or an indication disappears quickly after the balance is switched on, battery capacity is low. In these cases, either charge the battery immediately or plug in the AC adapter.
4. Charging the battery while [  ] is displayed reduces battery life.



**Cautions** To operate the balance safely, observe the following (failure to do so could result in malfunctions, breakage, burst batteries, or fire):

1. Do not disassemble or modify the battery. Do not reverse the balance connection or short-circuit the positive and negative polarities of the balance.
2. Use only the supplied AC adaptor.
3. Do not incinerate used batteries. Dispose as hazardous material only.

# 11. Troubleshooting

※ The numbers in ( ) indicate reference pages

Symptom	Cause	Possible remediation
There is no indication on the display.	<ul style="list-style-type: none"> <li>The AC adapter is not connected.</li> </ul>	→ Check that the AC adapter is connected (8).
The display is unstable. [M] remains flashing without changing.	<ul style="list-style-type: none"> <li>The balance is subject to air currents or vibration.</li> <li>The balance is situated on an unstable surface.</li> <li>An object is contacting the sample being measured, the measuring pan, or the tare.</li> </ul>	→ Check Precautions on Use (2–4).
Weight indication contains an error.	<ul style="list-style-type: none"> <li>An error was made in the tare subtraction procedure.</li> <li>The adjusters remain lifted, resulting in an incorrect level.</li> <li>The indication values are inconsistent after long hours of use, or because the balance has been moved to a new location.</li> </ul>	→ Review the tare subtraction (10). → Check the level (8). → Execute span adjustment on the balance (27).
The limit function does not work.	<ul style="list-style-type: none"> <li>The limit function is not selected.</li> <li>The limit value has been erroneously entered.</li> </ul>	→ Check the operation of the limit function (22 on).
[Add] appears (▶) and a value flash at [LO].)	<ul style="list-style-type: none"> <li>Likely to produce errors in the counting mode because the sample weight is insufficient.</li> </ul>	→ Execute the Memory Update Method (19).
[o-Err] appears before the capacity is reached.	<ul style="list-style-type: none"> <li>Gross weight exceeded the capacity of the balance (weight range = container + weight of sample).</li> <li>A section of the mechanism is damaged.</li> </ul>	→ Check the total weight. → Execute tare subtraction again. → Contact our local dealer.
[u-Err] is displayed.	<ul style="list-style-type: none"> <li>A foreign object is caught between the measuring pan (pan base) and the balance.</li> <li>A section of the mechanism is damaged.</li> </ul>	→ Remove the measurement pan and examine the surface beneath it.
[b-Err] is displayed. [d-Err] is displayed.	<ul style="list-style-type: none"> <li>The balance is exposed to static electricity or noise.</li> <li>The electrical system of the balance is malfunctioning.</li> </ul>	→ Contact our local dealer.
During span adjustment [o-Err] is displayed. [1-Err] is displayed. [2-Err] is displayed.	<ul style="list-style-type: none"> <li>A weight heavier than the capacity was used.</li> <li>The reference weight is less than 50% of the capacity.</li> <li>Calibration produced an error of 1.0% or more.</li> </ul>	→ Check that the span adjustment procedure was performed correctly (27).
During battery installation: The indication disappears. [ ] flashes. No indication is produced.	<ul style="list-style-type: none"> <li>The automatic power-off function was activated.</li> <li>The battery capacity is low.</li> </ul>	→ Switch on the power again. Deactivate the Automatic power-off function, if necessary (13). → Recharge the battery (29). → Operate the balance with the AC adapter.



## 12. Specifications

### 12.1 Basic Specifications

Model	SJ-220CE	SJ-420CE	SJ-620CE	SJ-1200CE	SJ-2200CE	SJ-4200CE	SJ-6200CE	SJ-12KCE
Max [g]	220	420	620	1200	2200	4200	6200	12000
Min [g]	0.2	0.2	0.5	5	5	5	5	50
e [g]	0.01	0.01	0.1	0.1	0.1	0.1	1	1
d [g]	-	-	0.01	-	-	-	0.1	-
Max [ct]	1100	2100	3100	6000	11000	21000	Not available	
Min [ct]	2	2	5	50	50	50		
e [ct]	0.1	0.1	1	1	1	1		
d [ct]	-	-	0.1	-	-	-		
Measurable unit weight in counting mode [g]	0.01	0.01	0.01	0.1	0.1	0.1	0.1	1
Minimum weight in percentage mode [g]	1	1	1	10	10	10	10	100
Pan Size [mm]	∅ 140			170 × 140	180 × 160			

### 12.2 Common Specifications

- (1) Weight measuring method..... Tuning fork vibration method
- (2) Tare subtraction range..... Total capacity
- (3) Liquid-crystal display (LCD)..... Seven segments (two segments in leading part),  
Maximum digits indication: seven digits,  
Segment height: 16.5 mm.
- (4) Calibration (span adjustment)..... Span adjustment with external weight  
(possible only when unsealed.)
- (5) Overload indication ..... [o-Err] is displayed if weight capacity + 9 intervals  
are exceeded.
- (6) Compatible printer ..... CSP-160
- (7) Operating temperature and humidity ranges .. 10°C to 30°C, 80%rh or less
- (8) AC adapter..... Dedicated AC adapter: 230V AC / 9V - 12V DC
- (9) Lower limit of battery voltage ..... 6V
- (10) Options ..... RS232C output  
under weighing hook  
Relay contact output

## 12.3 Capacities and Minimum Indications for Different Indication Units

	SJ-220CE	SJ-420CE	SJ-620CE	SJ-1200CE	SJ-2200CE	SJ-4200CE	SJ-6200CE	SJ-12KCE
gram(g)	220 0.01	420 0.01	620 0.01	1200 0.1	2200 0.1	4200 0.1	6200 0.1	12000 0.1
carat(ct)	1100 0.1	2100 0.1	3100 0.1	6000 1	11000 1	21000 1	Not available	
ounce(oz)	7.7 0.001	14 0.001	21 0.001	42 0.01	77 0.01	140 0.01	210 0.01	420 0.01
pound(lb)	0.48 0.0001	0.92 0.0001	1.3 0.0001	2.6 0.001	4.8 0.001	9.2 0.001	13 0.001	26 0.001
troy ounce(ozt)	7 0.001	13 0.001	19 0.001	38 0.01	70 0.01	130 0.01	190 0.01	380 0.01
penny weight (dwt)	140 0.01	270 0.01	390 0.01	770 0.1	1400 0.1	2700 0.1	3900 0.1	7700 0.1
tael(tl) (Hong Kong)	5.8 0.001	11 0.001	16 0.001	32 0.01	58 0.01	110 0.01	160 0.01	320 0.01
tael(tl) (Singapore, Malaysia)	5.8 0.001	11 0.001	16 0.001	31 0.01	58 0.01	110 0.01	160 0.01	310 0.01
tael(tl) (Taiwan)	5.8 0.001	11 0.001	16 0.001	32 0.01	58 0.01	110 0.01	160 0.01	320 0.01
momme (mom)	58 0.01	110 0.01	160 0.01	320 0.1	580 0.1	1100 0.1	1600 0.1	3200 0.1
tola(to)	18 0.001	36 0.001	53 0.001	100 0.01	180 0.01	360 0.01	530 0.01	1000 0.01

※ The view of the table

Upper cell : Capacity
Lower cell : Readability

### 13. Conversion Table of Units

unit	gram	carat	ounce	pound	troy ounce	penny weight
1g	1	5	0.03527	0.00220	0.03215	0.64301
1ct	0.2	1	0.00705	0.00044	0.00643	0.12860
1oz	28.34952	141.74762	1	0.06250	0.91146	18.22917
1lb	453.59237	2267.96185	16	1	14.58333	291.66667
1ozt	31.10348	155.51738	1.09714	0.06857	1	20
1dwt	1.55517	7.77587	0.05486	0.00343	0.05	1
1tl (Hong Kong)	37.429	187.145	1.32027	0.08252	1.20337	24.06741
1tl (SGP,MYS)	37.79936	188.99682	1.33333	0.08333	1.21528	24.30556
1tl (Taiwan)	37.5	187.5	1.32277	0.08267	1.20565	24.11306
1mom	3.75	18.75	0.13228	0.00827	0.12057	2.41131
1to	11.66380	58.31902	0.41143	0.02571	0.37500	7.5

unit	tael (Hong Kong)	tael (Singapore, Malaysia)	tael (Taiwan)	momme	tola
1g	0.02672	0.02646	0.02667	0.26667	0.08574
1ct	0.00534	0.00529	0.00533	0.05333	0.01715
1oz	0.75742	0.75	0.75599	7.55987	2.43056
1lb	12.11874	12	12.09580	120.95797	38.88889
1ozt	0.83100	0.82286	0.82943	8.29426	2.66667
1dwt	0.04155	0.04114	0.04147	0.41471	0.13333
1tl (Hong Kong)	1	0.99020	0.99811	9.98107	3.20899
1tl (SGP,MYS)	1.00990	1	1.00798	10.07983	3.24074
1tl (Taiwan)	1.00190	0.99208	1	10	3.21507
1mom	0.10019	0.09921	0.1	1	0.32151
1to	0.31162	0.30857	0.31103	3.11035	1





