

# High-Precision Advanced Tuning Fork Balance

## LNA Series

### Operation Manual

#### **IMPORTANT**

- To ensure safe and proper use of the balance, please read this manual carefully.
- After reading this manual, store it in a safe place near the balance, so you can review it as needed.

SHINKO DENSHI CO., LTD.



# PREFACE

---

Thank you for purchasing an LNA series electronic balance. This is an electronic balance for light and heavy industry, R&D and laboratory purpose.

The LNA series also provides enhanced functions, including a counting mode for stock control of parts, a percentage mode for comparative measurements given in percentages, and a comparator function.

## Instructions

- The copyright of this document belongs to SHINKO DENSHI CO., LTD.. Reprinting or duplicating of all or part of this document without notice shall not be allowed.
- Please note that product improvement or modification may cause partial discrepancy between the product and the description of this document.
- The description of this document is subject to change without notice.
- This document has been created carefully. In case that, however, any error or imperfection is found by any chance, please let us know.
- Documents of which pages are missing or irregularly bound will be exchanged. Please inform the store where you purchased the product.
- Trouble related to the product or system will be dealt with in accordance with the individual maintenance contract. Please note, however, that we will not take responsibility for consequential trouble such as discontinuation of operation caused by the product trouble.
- **VIBRA** is the registered trademark of SHINKO DENSHI CO., LTD.. Company names and product names appearing in this document are the trademarks or registered trademarks of the respective company concerned.

# Important Notice

---











- It should be known that this product contains potential danger. And so please be sure to observe this document when installing, operating or servicing this product.
- If the product is used in a manner not specified by the manufacturer, the protection provided by the product may be impaired.
- SHINKO DENSHI CO., LTD. will not take any responsibility for any injury or damage caused by the non-observance of this document or misuse or unauthorised modification of this product.

- Potential dangers are increasing in the industrial equipment industries due to the advent of new materials and processing methods, and speeding up of machines. It is impossible to foresee all situations related to these dangers. In addition, there are so many “impossible” and “don’ts” and so writing all of them in the operation manual is impossible. Therefore, it is safe to think that what is not written in the operation manual “cannot be performed” unless the operation manual positively writes “it is possible.” When performing installation, operation, maintenance or inspection of this product, not only observe what is written or indicated in this document or on the product surface but also pay adequate consideration to safety measures.
- The copyright of this document is held and reserved by SHINKO DENSHI CO., LTD. Duplicating or disclosing its drawings and engineering materials without prior approval of SHINKO DENSHI CO., LTD. in writing is not permitted.
- For any question or further information concerning this document, please contact the store where you purchased the product or with its model (type) name and serial number informed.
- Manufacturer: SHINKO DENSHI CO., LTD.  
Address: 1-52-1 Itabashi, Itabashi-ku, Tokyo 173-0004 Japan

## How to read this manual

### ■ Symbols used in this document

Understand the meaning of the following symbols and observe the instructions of this document.







Symbols	Meaning
	Used for the situation that invites an imminent risk of death or severe injury if proper precautions are not taken.
	Used for the situation that invites a risk of death or serious injury if proper precautions are not taken.
	Used for caution concerning operations that may lead to a light physical injury to persons if proper precautions are not taken.
	Used for notation concerning operations that may lead to damage of the products/facilities/data if proper precautions are not taken. Used for accurate weighing and appropriate usage of the equipment.
	Used for reference information on operation
	Used for “Prohibition” items
	Used for “Mandatory” items requiring positive action
	Used for prohibition items to avoid “Electrical shock”.

This product/ The product/ The balance	Refers to the product.
[On/Off] key	The name of an operation key located in front of the main unit is represented in square brackets “[ ]”.
<message>	A message on the display is represented in angle brackets “< >”.
Press the key/ Brief press the key	Signifies pressing lightly an operation key once.
Press and hold down the key	Signifies keeping pressing an operation key until the designated indication appears.

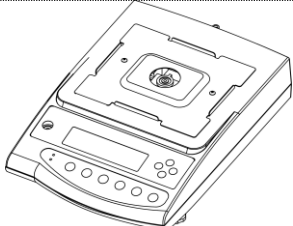
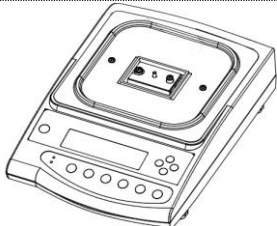
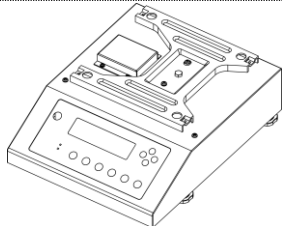
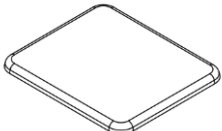
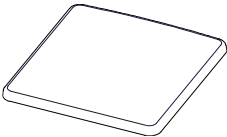
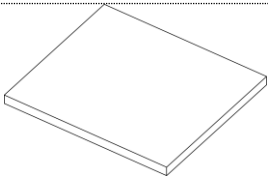
## Bundled Items

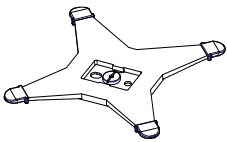
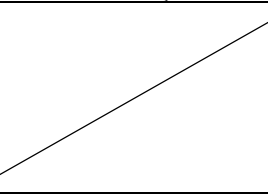
Before using the balance, please check that the following items have been included in the package.

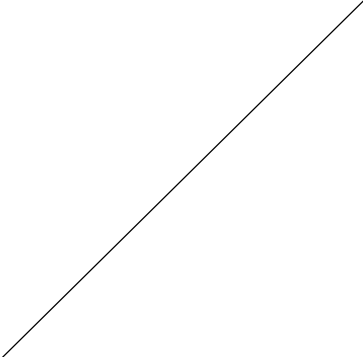
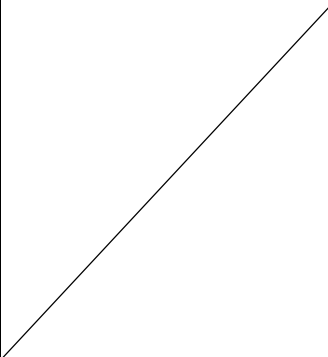
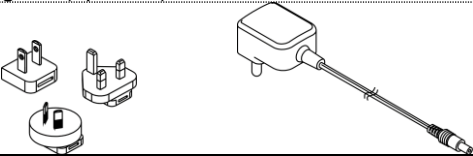
Should you find any missing parts, please contact your local dealer.

Models with a capacity of up to 620 g	Models with a capacity of 1200 g to 15 kg	Models with a capacity of 21 kg or 31 kg
<b>(1) Main unit of balance</b>		
		
<b>(2) Weighing pan</b>		
		
<b>(3) Pan base</b>		
		
<b>(4) Windshield</b>		
		
<b>(5) AC adapter and AC plug set (optional)</b>		
		
<b>(6) Operation manual</b>		
		

# Contents

---

PREFACE.....	i
Important Notice .....	ii
How to read this manual.....	iii
Bundled Items.....	iv
1 Prior to use.....	1
1.1 Operating precautions.....	1
1.2 For More Precise Measurements.....	3
1.2.1 Precautions on the Measuring Room.....	3
1.2.2 Precautions on the Measuring Bench .....	3
1.2.3 Precautions on the Samples .....	4
1.2.4 Precautions on the Main Unit of the Balance.....	4
2 Name and Function of Each Section .....	5
2.1 Main Unit .....	5
2.2 Displayed Signs and Operation Keys.....	6
2.2.1 Segment Display.....	6
2.2.1.1 7-Segment Characters .....	7
2.2.2 Operation keys and LED indicators .....	8
3 Assembling and Installation .....	9
3.1 Assembling and installation of the balance.....	9
3.2 Windshield Assembly (For models with a capacity of up to 620 g).....	10
3.3 For Hanging Measurement .....	11
4 Basic Operations.....	11
4.1 Start-Up and Operation Check.....	12
4.2 Zero-Point Adjustment.....	13
4.3 Tare subtraction.....	13
4.4 Display the gross weight .....	14
4.5 Weigh the sample (Weighing Mode) .....	15
5 Function Setting Modes .....	17
5.1 Basic Function Setting Mode .....	17
5.1.1 Setting of Basic Functions .....	17
5.1.2 Description of Basic Functions .....	18
5.2 Advanced Function Setting Mode .....	23
5.2.1 Launching of Advanced Functions.....	23
5.2.2 Description of Advanced Functions .....	23
6 Measuring Modes and Functions.....	24
6.1 Weighing Mode .....	25
6.2 Counting Mode .....	26

6.3	Percentage Mode .....	29
6.3.1	Set a reference weight by weighing an actual sample .....	29
6.3.2	Set a reference weight by entering a value .....	31
6.4	Multiplied by Coefficient mode.....	33
6.5	Specific Gravity mode.....	35
6.5.1	Measurement procedures for specific gravity .....	35
6.5.2	Specific gravity measurement data output.....	38
6.6	Statistics Mode .....	38
6.6.1	Calculation items.....	39
6.6.2	Operational procedure .....	40
6.6.3	Statistical calculation result display .....	42
6.6.4	Outputting the statistical calculation results.....	42
6.7	Addition Function.....	44
6.7.1	Addition Function Setting.....	44
6.7.2	Cumulate Method Operation.....	45
6.7.3	Net Addition Method Operation.....	46
6.8	Comparator Function.....	47
6.8.1	Setting of the Comparator Function.....	47
6.8.2	Configuration of the thresholds.....	49
6.8.2.1	Judge by Absolute Values.....	50
6.8.2.1.1	Set absolute value by placing actual sample on the balance .....	50
6.8.2.1.2	Set absolute value by key stroke .....	51
6.8.2.2	Judge by Deviation Values.....	52
6.8.2.2.1	Set deviation value by placing actual sample on the balance .....	52
6.8.2.2.2	Set deviation value by key stroke .....	53
6.8.3	Indication of Judgment Result .....	55
7	Settings According to the Measurement Environment.....	56
8	Miscellaneous Functions and Settings.....	57
8.1	Power settings .....	57
8.1.1	Auto Sleep Function.....	57
8.1.2	Direct Start Function .....	57
8.2	Date and Time Indication and Setup .....	57
8.3	ID No. Indication and Setup .....	59
8.4	Power-on Tare Recall Function .....	60
9	Input/Output Functions.....	61
9.1	D-SUP9P Connector for RS232C I/O.....	61
9.1.1	Connector pin numbers and functions .....	61
9.1.2	Connecting between Balance and Peripheral .....	62
9.1.3	Interface specifications .....	63





9.2	DIN 8-pin Connector for Serial Output for Peripherals.....	64
9.2.1	Connector pin numbers and functions.....	64
9.2.2	Interface specifications .....	65
9.3	Output Data.....	66
9.3.1	Bit configuration for each format.....	66
9.3.2	6/7-digit numeric format and extended 7-digit numeric format.....	66
9.3.2.1	Data composition .....	66
9.3.3	Special format 1 .....	69
9.3.3.1	Data composition .....	69
9.3.3.2	Error output.....	70
9.3.4	Special format 2.....	70
9.3.4.1	Data composition .....	70
9.3.4.2	Error output.....	71
9.3.5	CBM format.....	72
9.3.5.1	Data composition .....	72
9.3.6	Interval Output Function .....	74
9.3.6.1	Set interval output.....	74
9.3.6.2	Set interval time .....	74
9.3.6.3	Start interval output.....	75
9.3.6.4	Stop interval output.....	75
9.3.6.5	Data format .....	75
9.3.7	Time Stamp Output.....	75
9.4	Input Commands .....	76
9.4.1	Procedure for transmission.....	76
9.4.2	Response.....	77
9.4.3	Input Command Format 1.....	78
9.4.4	Input Command Format 2.....	81
10	Calibration of the balance .....	82
10.1	Select the calibration mode.....	82
10.2	Span Adjustment with Internal Calibration Weight (Semi-Automatic Span Adjustment).....	83
10.3	Span Adjustment with External Weight .....	84
10.4	Span Test with Internal Calibration Weight .....	85
10.5	Span Test with External Weight.....	86
10.6	Advice CAL.....	87
10.7	Calibration of the Internal Calibration Weight.....	88
10.8	Setup and reflection of instrumental error of the external calibration weight.....	90
10.9	Output of span adjustment / span test results.....	92
10.10	ISO/GLP/GMP form output of measurement data .....	93

11	Cleaning the balance.....	97
12	Troubleshooting .....	98
13	Specifications .....	100
13.1	Metrological Specifications .....	100
13.2	Functional Specifications.....	101
13.3	Display, readability and capacity by each weighing unit .....	102
13.4	Conversion Table of Units.....	104
13.5	Open source software used in this product.....	105



# 1 Prior to use

## 1.1 Operating precautions

### **DANGER**

	<p>■ <b>Do not wet the AC adapter.</b> That may cause an electric shock, short-circuiting or failure.</p>
	<p>■ <b>Do not handle the AC adapter with wet hands.</b> That may cause an electric shock, short-circuiting or failure.</p>
	<p>■ <b>Do not use the balance in a dusty location.</b> That may cause dust explosion or fire.</p>
	<p>■ <b>Do not use the balance in explosive atmosphere.</b> That may cause short-circuit or malfunction of the balance.</p>
	<p>■ <b>Do not use the balance in explosive atmosphere.</b> That may cause explosion or fire. Please order our explosive-proof balances to weigh in such a hazardous area.</p>
	<p>■ <b>Obey the SDS of the object to be weighed.</b> Measuring dangerous materials such as flammable liquid could cause an explosion or fire.</p>



### **WARNING**

	<p>■ <b>Do not disassemble or modify the product.</b> Doing so could result in injury, electric shock, fire and other accidents or failures. For inspection and adjustment, contact the retailer from whom the product was purchased.</p>
	<p>■ <b>Do not move the product with a sample to be weighed set on the balance.</b> That may cause the sample to fall from the measurement pan, leading to a bodily injury or destruction of the sample.</p>
	<p>■ <b>Do not route the cables across passages.</b> The cables could be tripped on by a passer-by and the balance and sample could fall down and break or injure someone.</p>
	<p>■ <b>Do not use the product on an unstable table or a place that is subject to vibration.</b> That may cause the sample to fall from the measurement pan, leading to a bodily injury or destruction of the sample. Besides inaccurate weighing may result.</p>
	<p>■ <b>Do not place an unstable sample on the measurement pan.</b> The sample may fall down, giving rise to a danger. Put an unstable sample in a container (tare) before weighing it.</p>
	<p>■ <b>Only use the specified power supply.</b> Using any power supply other than that specified could cause overheating, fire, electric shock, heat generation or malfunction of the balance.</p>
	<p>■ <b>Do not use the product in an abnormal condition.</b> If it should happen that an abnormal event such as smoking or unusual odour occurs, ask the store where you purchased the product or our sales department for repair. Keeping using the product may result in an electric shock or fire. In addition, do not ever try to repair it for yourself, or very dangerous situation is likely to occur.</p>
	<p>■ <b>Only use the dedicated AC adapter.</b> Use of other types of power or adapters may result in fire, electric shock, heat generation or malfunction of the balance.</p>

 **CAUTION**

	<p>■ <b>Do not handle the balance with wet hands.</b> That may cause short-circuiting or failure.</p>
	<p>■ <b>Do not use the balance in a wet location.</b> That may cause short-circuiting or failure.</p>
	<p>■ <b>Do not connect to the AC adapter cord or communication cable with its connector or jack being wet.</b> That may cause short-circuiting or failure.</p>

Note

	<p>■ <b>Do not apply excessive force to or impact the balance.</b> Doing so could damage or result in failure of the balance. Carefully place samples on the balance.</p>
	<p>■ <b>Do not use volatile solvents.</b> The main unit could deform. Wipe the main unit using dry cloth or a cloth moistened with a small amount of neutral detergent.</p>
	<p>■ <b>Do not install the balance in a place where it is directly exposed to airflow from air-conditioning or heating equipment.</b> Due to changes in the ambient temperature, the balance could fail to accurately weigh samples.</p>
	<p>■ <b>Do not install the balance in a place exposed to direct sunlight.</b> The internal temperature of the balance could rise and the balance could fail to accurately weigh samples.</p>
	<p>■ <b>Do not install the balance in a place where the ambient temperature or humidity change significantly.</b> The balance could fail to accurately weigh samples.</p>
	<p>■ <b>Adjust (calibrate) the balance when it is installed or relocated.</b> Failure to do so might result in measurement errors. To ensure accurate measurements be sure to adjust (calibrate) the balance.</p>
	<p>■ <b>Check for an error periodically.</b> Use environment and chronological change cause an error in measured value, leading to an inaccurate measurement.</p>
	<p>■ <b>Unplug the AC adapter from the receptacle when the balance is not going to be used for a long period of time.</b> Unplug the balance from the receptacle to save energy and prevent degradation.</p>
	<p>■ <b>Always adjust the level of the balance before use.</b> A tilted balance generates errors which might cause inaccurate weighting.</p>

Note

	<p>■ <b>For proper disposal</b> This product including accessories may not be disposed of in domestic waste in conformance with the specific requirements in your country, such as the European Directive 2012/19/EU on waste electrical and electronic equipment (WEEE). When you dispose of this product, please contact your local dealer and ask for the correct method of disposal.</p>
---	--

## 1.2 For More Precise Measurements

To make more accurate measurement, it is necessary to lessen error-causing factors in measurement to the extent possible. Error-causing factors include not only an instrument error and performance of the balance itself but also the nature and condition of a specimen, measuring environment (vibration, temperature, humidity, etc.) and the like. These factors will directly affect measurement result in the case of a balance with high resolution capability.

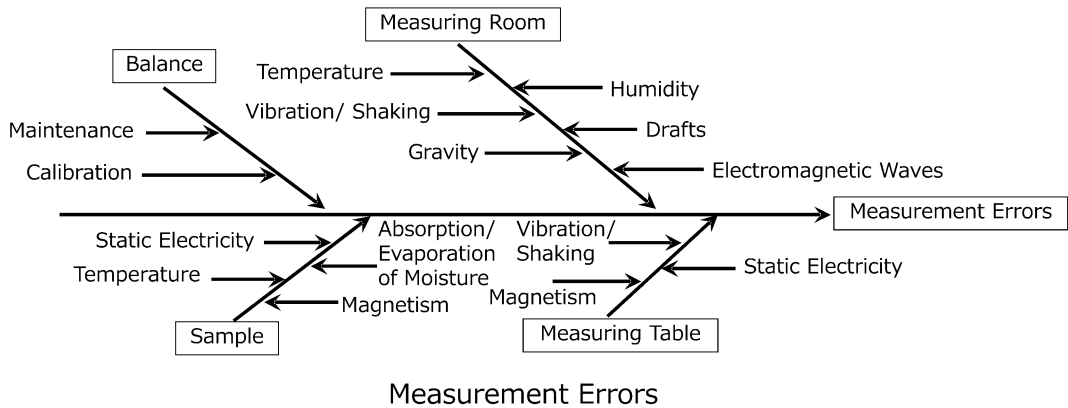

### 1.2.1 Precautions on the Measuring Room

- Temperature/ Humidity/ Atmospheric pressure      Try to keep the room temperature constant to the extent possible in order to avoid condensation and indication drift due to change in temperature. Low humidity is likely to cause generation of static electricity, resulting in inaccurate measurement. Change of atmospheric pressure is likely to cause change of buoyancy of the air on the specimen, tare and mechanism of the balance, resulting in inaccurate measurement.
- Vibration/Shaking      The measuring room should preferably be located on the ground floor or in the basement. Higher floors are more susceptible to heavy vibration and shaking, which make such locations less suitable for measurement. A room facing a railway or road with heavy traffic should also be avoided as much as practicable.
- Draught      Avoid choosing a location subject to a direct draught of airflow from an air-conditioning unit or exposed to direct sunlight, which may cause abrupt fluctuations in temperature. Also avoid a room subject to a heavy flow of people, since fluctuations in draughts and temperature are likely to occur in such a location.
- Gravity      The gravity acting on a sample varies depending on the latitude and altitude of the location where measurement is being conducted. For this reason, the same sample may show different weight indications from one place to another. Therefore, make it a rule to calibrate the balance every time it is relocated.
- Electromagnetic wave      When the balance is located near an object that generates intense electromagnetic waves, it may be hindered from showing accurate weight due to the effects of such waves. Therefore, avoid placing the balance in such a location.

### 1.2.2 Precautions on the Measuring Bench

- Vibration/Shaking      If the balance is subjected to vibration during measurement, its indications will become unstable, thus preventing accurate measurement from being conducted. To avoid this situation, select a solid measuring bench that is less susceptible to vibration. (A bench in a vibration-proof structure or one made of concrete or stonework will be suitable.) Moreover, do not conduct measurement with a soft cloth or paper placed under the balance, since the balance may be rocked out of its precise level positioning. Place the measuring bench in a location free from vibration as much as possible. A corner rather than the centre of a room is less affected by vibration and therefore more suitable for installation of the balance.
- Magnetism/Static Electricity      Avoid operating the balance on a bench that is susceptible to the effects of magnetism or static electricity.

### 1.2.3 Precautions on the Samples

- Static Electricity      In general, synthetic resin- and glass-made samples are high in electric insulation, and so easily charged electrically. Weighing an electrically charged specimen makes the indication value unstable, reducing the reproducibility of the test result. Therefore, neutralise an electrically charged specimen before measurement.
- Magnetism              A sample affected by magnetism indicates different weight values depending on where it is located on the measurement pan, along with resultant poor reproducibility of the results. When a magnetised sample must be measured, first demagnetise it or place an appropriate pedestal on the measurement pan to adequately separate the mechanism part of the balance from the magnetised sample for avoiding the effects of magnetism.
- Absorption/  
Evaporation  
of Moisture              Measuring a sample with moisture absorbed or evaporated (volatilised) continuously increases or decreases the values indicated. In such case, measure the sample in a container with a small opening and sealed airtight with a cap.
- Sample Temperature      A difference in temperature between a sample and the interior of a windshield may cause convection to occur inside the windshield, resulting in erroneous measurement. Therefore, measure a very hot or cold sample only after allowing time for its temperature to acclimatise to room temperature. Moreover, to prevent convection inside the windshield, allow time for the interior of the windshield to acclimatise to room temperature.  
The body heat of a person conducting measurement can also affect measurement results. Avoid holding the sample with bare hands, and use long tweezers or a similar tool instead. Also refrain from putting your hands inside the windshield while measurement is in progress.

### 1.2.4 Precautions on the Main Unit of the Balance

- Precautions on Use      The balance is supplied with a transparent dust cover. The dust cover may be statically charged immediately after removal from the packing box or under low humidity conditions. Unstable indications by the balance may be due to statically charged dust cover. In such case, wipe the dust cover with a damp cloth or use a commercial antistatic agent. For more accurate measurement, it is recommended to energise the balance for longer than 30 minutes and load the balance a few times with a weight equivalent to the maximum capacity before measurement.
- Calibration              Periodically calibrate the balance to ensure accurate measurement at all times. For more precise calibration, use an external calibration weight that approximates the maximum capacity. Moreover, calibrate the balance only after allowing time for proper acclimation to ambient temperature following power-up. For more accurate calibration, it is recommended to energise the balance for longer than 30 minutes and load the balance a few times with a weight equivalent to the maximum capacity before adjustment.  
Calibration is also required in the following cases:
  - When operating the balance for the first time;
  - When not using the balance for a long time;
  - When relocating the balance; or
  - When there is wide fluctuation in temperature, humidity or atmospheric pressure.
- Maintenance              When the measurement pan or pan base is contaminated with powder or liquid, erroneous weight values may result or indications may remain unstable. Therefore, be sure to frequently clean them. When cleaning the balance body, be very careful not to allow dirt or liquid to penetrate inside the enclosure.

## 2 Name and Function of Each Section

### 2.1 Main Unit

Models with a capacity of up to 620 g	Models with a capacity of 1200 g to 15 kg	Models with a capacity of 21 kg and 31 kg
<b>Front view</b>		
<b>Rear view</b>		
<b>Bottom view</b>		
① Level	② Display	③ Operation keys
④ Weighing pan	⑤ Adjuster legs	⑥ AC adapter jack
⑦ D-SUP9PConnector for RS232C I/O (male)	⑧ DIN 8-pin Connector for Serial Output for Peripherals	⑨ Underfloor weigher hole cover (Refer to “3.3 For Hanging Measurement”.)
⑩ Antitheft hole (Only for models with a capacity up to 15 kg)	⑪ Windshield (Only for models with a capacity of up to 620 g)	

## 2.2 Displayed Signs and Operation Keys



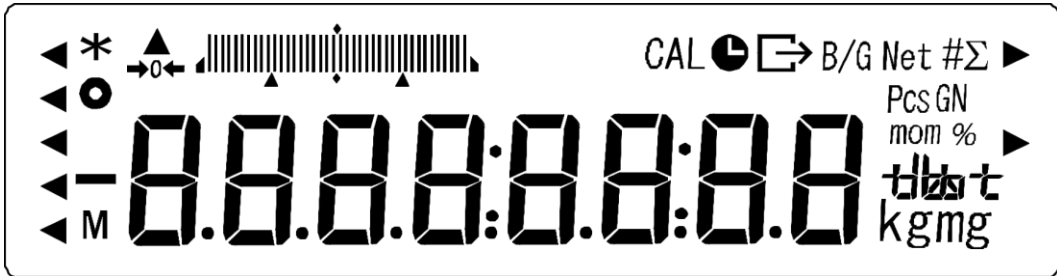



















### 2.2.1 Segment Display



Display	Description
kgmg	kilogram, gram, milligram
GN	grain
mom	momme
→0←	Zero-point
-	minus
Net	Indicates that the tare weight is being subtracted and net weight is displayed.
B/G	Indicates that gross weight is being displayed.
○	Indication of stable balance (Indicates that readout is stable.)
*	Indicates addition available status when the addition function is used.
Pcs	Indicates that the balance is in counting mode.
#	Indicates that the balance is in multiplied by coefficient mode.
%	Indicates that the balance is in percentage mode.
Σ	Lights up when sum total is displayed when the addition function or statistics mode is used.
☞	Indicates that data is being output.
🕒	- Lights up when date/time is being set or displayed. - Blinks during interval output.
▶	- Indicates the judgement result of the comparator function. - Lights up in some modes/functions.
M	- Lights up during data entry in some modes. - Blinks when the balance is in processing.
CAL	Lights up or blinks during span adjustment or span test is in operation.
	Bar graph - Shows the rate of gross weight to the weighing capacity in each measuring mode. - Shows judgement result of comparator function.
	- Lights up to indicate each weighing unit. (Refer to "13.3 Display, readability and capacity by each unit of weighing" for indication of each unit.) - Lights up in some modes/functions.
▶▶	







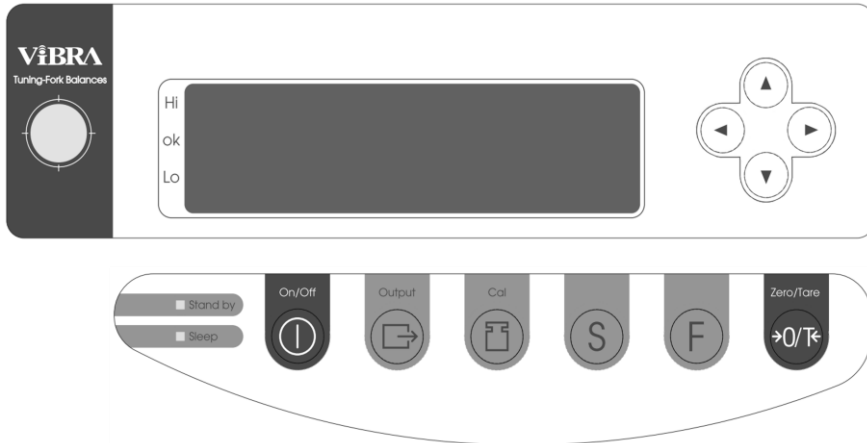

2.2.1.1 7-Segment Characters

										
A	b	C	c	d	E	F	G	H	I	J
										
L	M	n	o	P	r	S	t	u	W	y

## 2.2.2 Operation keys and LED indicators



Operation key		Typical functions
	[On/Off] key	Turns the balance on or off.
	[Output] key	- Starts output. - Used to cancel the various settings.
	[S] key	Brief press: Used to confirm the function setting. Brief press: Used to perform addition when addition function is activated. Press and hold down: Starts the setting of thresholds when the comparator function is enabled. Press and hold down: Starts the setting of interval time when interval output is enabled.
	[F] key	Brief press: Switches the indication. Brief press: Used to enter numerical values. Brief press: Used to select a function to set. Press and hold down: Invokes function setting mode.
	[Zero/Tare] key	Brief press: Used for zero-setting or sets the display to zero by tare range. Brief press: Used to enter numerical values. Brief press: Used to select a function setting value.
	[Cal] key	Starts span adjustment or a span test.
	Arrow keys	The arrow keys function in the same way as the [F] key or the [Zero/Tare] key when you set functions or enter numerical values.
LED indicator		Description
LED (green)	Stand by	Lights up when the balance is connected to the power supply and in standby mode.
LED (orange)	Sleep	Lights up when the balance is in sleep mode.

## 3 Assembling and Installation

### 3.1 Assembling and installation of the balance

- 1 For models with a capacity of up to 15 kg: Attach the pan base and place the weighing pan.  
For models with a capacity of 21 kg and 31 kg: Pan base is pre-installed and only the weighing pan to be attached.

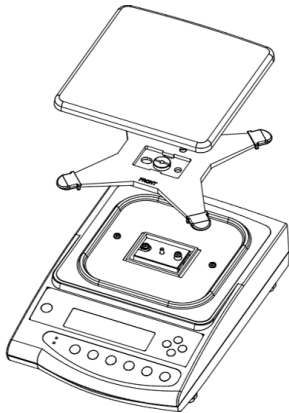

Attach the pan base to the main unit. Be sure that the "FRONT" indication is on the display side when attaching the pan base.

Align the bosses on the load receptor with the holes on the pan base then fasten the knurled nut or screw.

After attaching the pan base, put the weighing pan on it.

For models with a capacity of 1200 g to 15 kg, mount the weighing pan so that the arc-shaped edge is at the back and the straight edge is at the front.

- 2 Level the balance.

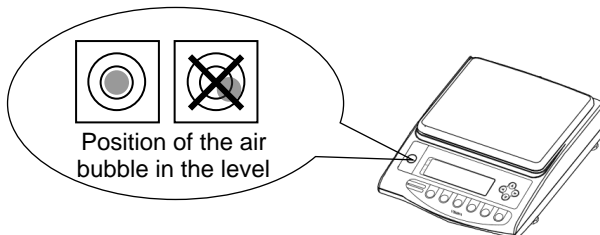

Turn the adjusters until the bubble rests in the centre circle of the level.

**Note**

Slightly push the four corners of the balance to make sure that there is no rattle.

- 3 Put the AC plug to the AC adapter, then connect the AC adapter.

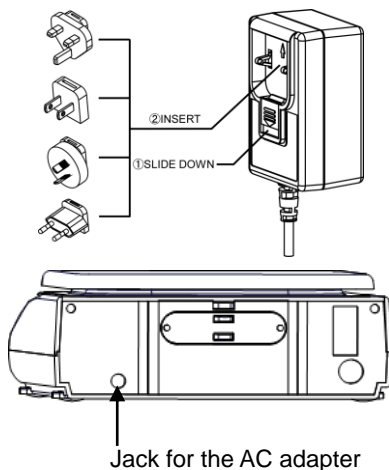

Connect the AC adapter to the balance, as illustrated at left.

**Note**

Take 5 minutes before operation.  
For more accurate measurements, a warm-up time of at least 30 minutes is recommended.

### 3.2 Windshield Assembly (For models with a capacity of up to 620 g)

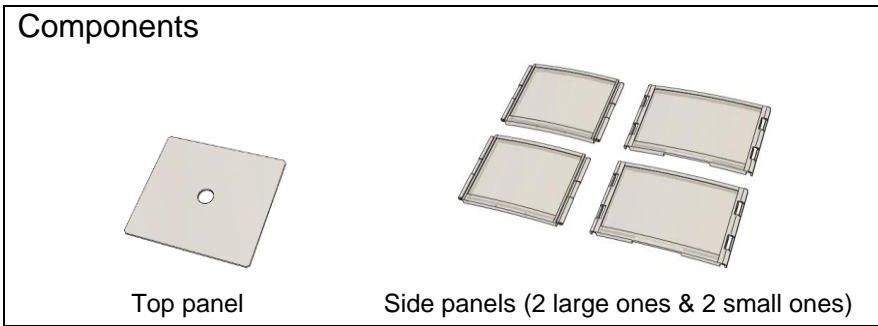

(1) Assemble small side panels and large side panels alternately, ensuring that the sides with flat guide face upwards.

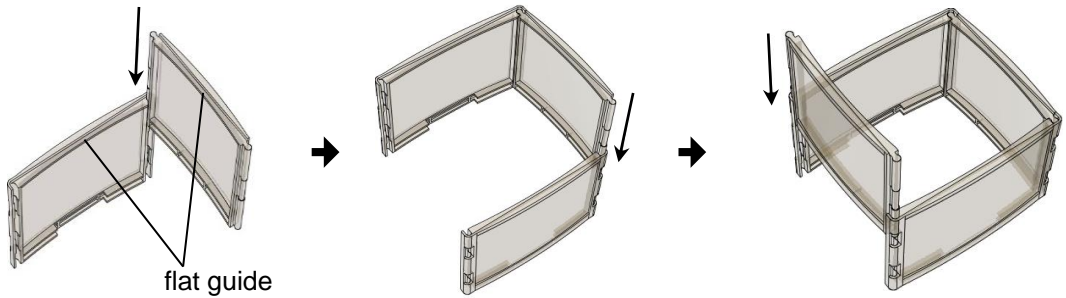

(2) Put the top panel and place the complete assembly along the guide of the balance.

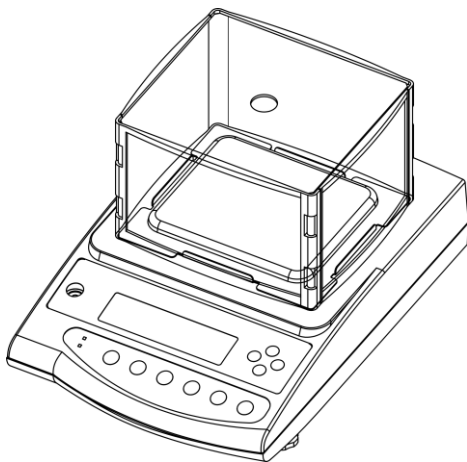

### 3.3 For Hanging Measurement

Loosen the screw of cover for hanging measurement and slide the cover in a clockwise direction.

For models with a capacity of 620 g, 21 kg and 31 kg, there is a hanger fitting pre-installed.

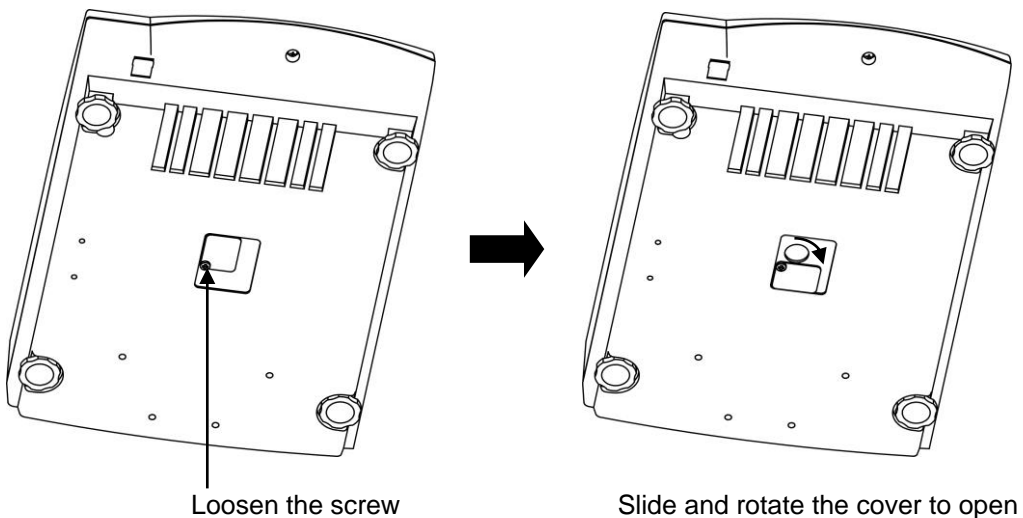

For models with a capacity of 1200 g to 15 kg, there is a threaded hole for attaching the optional hanger fitting. Purchase the hanger fitting option and install the fitting according to the instruction manual for the option.

You must provide your own hook, wire and measurement pan to be used for hanging measurement.

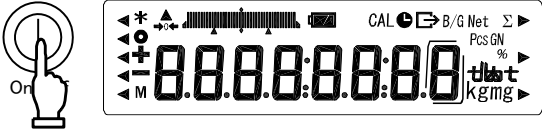
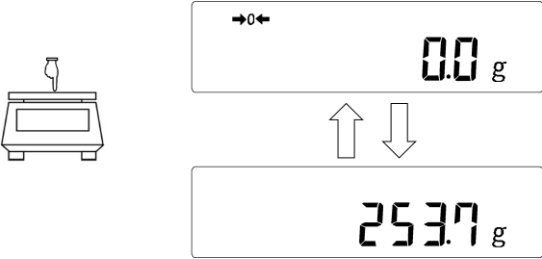

## 4 Basic Operations

### 4.1 Start-Up and Operation Check

<p>1</p> 	<p>Connect the AC adapter. The balance enters standby mode, and the Stand by lamp (LED) lights up.</p> <p>For accurate measurement, warm-up at least 5 minutes in standby before switching on. More than 30 minutes is more recommended.</p> <p>Press the [On/Off] key.</p> <p>All displays on the LCD lights, followed by the self-check of the balance. Check that there are no missing indications or unlit areas on the display.</p> <p>When self-check is completed, initial zero-point adjustment or tare subtraction is performed, the balance starts up in measuring mode and '0' is displayed.</p>
<p>2 Check changes of the display.</p> 	<p>Press the measurement pan lightly and make sure that the read-out indicator changes.</p> <p>Also, ensure that the read-out indicator is reset to zero when you release your hand.</p>
<p>3 Stand by</p> 	<p>Press the [On/Off] key again. The balance enters standby mode, and the Stand by lamp (LED) lights up.</p>

#### Reference

When you turn on the balance, it starts in the mode when it was turned off. For example, if you turn off the balance in the parts counting mode, it starts in the parts counting mode when it is turned on the next time.

## 4.2 Zero-Point Adjustment

Adjusting the indication to zero is called "Zero-point adjustment".

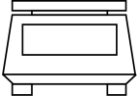
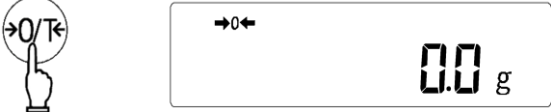

<p>1 Unload the balance.</p> 	<p>Make sure that nothing is placed on the weighing pan.</p>
<p>2 Execute zero-point adjustment</p> 	<p>Press the [Zero/Tare] key. The readout becomes zero, and &lt;→ 0 ←&gt; is displayed (zero-point adjustment).</p> <p><b>Reference</b> When the load exceeds the zero-point adjustment range, tare subtraction is activated and &lt;Net&gt; is displayed, instead of zero-point adjustment.</p>

**Reference**

Stability waiting during the Zero-point adjustment can be set using the function item <H. tA.>.

## 4.3 Tare subtraction

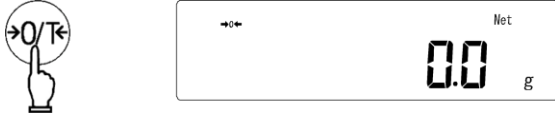
When measuring weight with the sample in a tare (container), only the sample is weighed by subtracting the weight of the tare. This is called "tare" or "tare subtraction".

<p>1 Place tare (container) on the balance.</p> 	<p>As the tare is placed on the weighing pan, the balance indicates its weight.</p>
<p>2 Reset the display to zero</p> 	<p>Press the [Zero/Tare] key. The tare is subtracted, the balance indicates zero and &lt;NET&gt; symbol appears.</p> <p><b>Reference</b> When the tare weight is within the zero-point adjustment range, zero point adjustment is activated instead of zero point adjustment.</p>
<p>3 Load the sample to be weighed.</p> 	<p>The balance will now indicate only the weight of the sample loaded in the tare.</p>





**Reference**

- When the tare is subtracted, the measurable range is reduced.

Measurable Range = Maximum Capacity - Tare Weight

- Stability waiting during the Zero-point adjustment can be set using the function item <H. tA.>.

## ☆ Weigh additional samples









<p>4 Reset the display to zero.</p>  	<p>Press the [Zero/Tare] key. The indication changes to zero and the &lt;NET&gt; symbol appears.</p>
<p>5 Put an additional sample on the balance.</p>  	<p>The balance indicates only the weight of added samples.</p>

## 4.4 Display the gross weight

The sum weight of the sample and the tare (container) is displayed (gross readout).

### Reference

- A gross weight can only be displayed when the measuring mode is "Weighing mode".
- When the tare weight is light, zero-point adjustment may be made instead of tare subtraction, in which case the sum of the tare weight and the sample weight cannot be indicated.
- Tare subtraction cannot be performed while the gross weight is displayed.



<p>1</p>  	<p>Place tare on the balance and then and then execute tare subtraction.</p>
<p>2</p>  	<p>Put a sample to weigh on the balance. The weight of only the sample is displayed (net readout).</p>
<p>3</p>  	<p>Press the [F] key. The sum weight of the tare and the sample is displayed (gross readout). When a gross weight is displayed, &lt;B/G&gt; lights up instead of &lt;NET&gt;.</p>
<p>4</p>  	<p>Press the [F] key several times to return to the net weight indication.</p>



## 4.5 Weigh the sample (Weighing Mode)

Weighing mode is the basic mode for weighing.

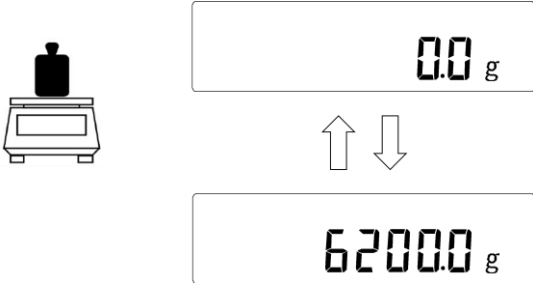
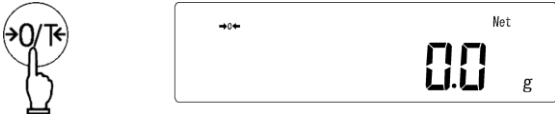
For other measuring modes, please refer to “6 Measuring Modes and Functions”.

<p>1 Ensure that the balance is in weighing mode in the intended weighing unit.</p>	<p>Ensure that the balance is in weighing mode in the intended weighing unit. If not, switch the weighing unit by referring “6 Measuring Modes and Functions”.</p>
<p>2 Preload the balance.</p> 	<p>Pre-load the balance several times with a load near the maximum capacity of the balance.</p>
<p>3 Execute zero-point adjustment or tare subtraction as appropriate.</p> 	<p>Refer to “4.2 Zero-Point Adjustment” or “4.3 Tare Subtraction” as appropriate.</p>
<p>4 Load the sample to be weighed.</p> 	<p>The balance will indicate the weight of the sample loaded.</p>

- The bar graph shows the current gross load status with respect to the maximum capacity of the balance.  
\* Even when the display currently indicates zero with the tare subtracted, the weight corresponding to the subtracted tare is indicated on the bar.



- When the balance remains stable, the stable state indicator <○> remains on. If the balance becomes unstable, the stable state indicator <○> will disappear.  
When a displayed value flickers or the stable state indicator flashes on and off, it is likely that the balance is being affected by wind, vibrations or other environmental factors. Use the windshield or vibration dampers to mitigate such adverse effects. Otherwise, refer to “7 Settings According to the Measurement Environment” to adjust the balance settings.

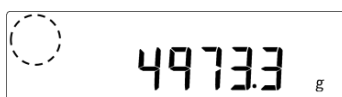

Unstable

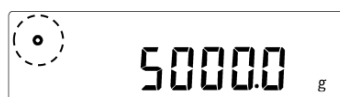

Stable

Reference

- When the zero-point adjustment is executed or the tare is subtracted, the balance indicates zero and <→0←> indicator appears. If the tare is subtracted, the <Net> indicator also appears.



If the measurement value deviates from the true zero point by 1/4 of the actual scale interval or more, <→0←> disappears.



If the zero-point adjustment is executed or the tare is subtracted, the balance indicates zero and <→0←> indicator appears.

- When the tare is subtracted, the measurable range is reduced.  
Measurable Range = Maximum Capacity - Tare Weight
- If <o-Err> appears when a sample is loaded, the gross weight exceeds the capacity of the balance.

## 5 Function Setting Modes

This product has two types of function setting modes: basic function setting mode and advanced function setting mode.

### 5.1 Basic Function Setting Mode

#### 5.1.1 Setting of Basic Functions

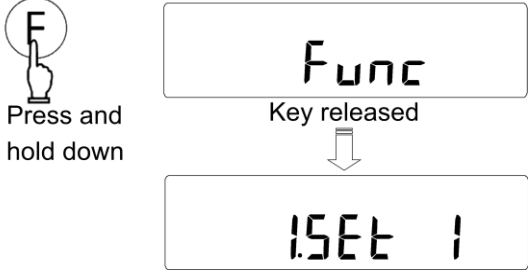
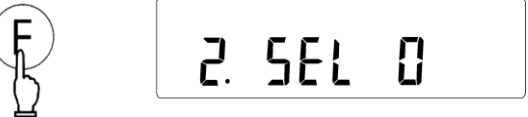
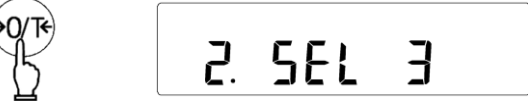
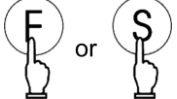
<p>1 Invoke the basic function setting mode.</p> 	<p>Press and hold down the [F] key until the indicator changes to &lt;Func&gt;, then release the key. The basic function setting mode is activated, and the first item, &lt;1. SEt&gt; (Measuring Mode) appears. (Refer to “5.1.2 Description of Basic Functions”).</p> <p><b>Reference</b></p> <p>(1) Depending on measuring mode, the display may switch to another indication before it reaches &lt;Func&gt;. In such a case, it can still be reached to &lt;Func&gt; by keeping pressing [F] key. (2) Keeping the [F] key held down after &lt;Func&gt; appears will switch the balance to another mode. If this happened, press the [Output] key to cancel the setting and redo this procedure from the beginning.</p>
<p>2 Select the function item.</p> 	<p>Press the [F] key several times to select the function item to be set.</p> <p><b>Reference</b></p> <p>Pressing the [F] key further from the last function item returns to the measuring mode.</p>
<p>3 Change the setting.</p> 	<p>Each press of the [Zero/Tare] key changes the digit on the right end. Select the desired one.</p> <p><b>Reference</b></p> <p>Pressing the [Output] key can cancel the setting.</p>
<p>4 Save the setting.</p> 	<p>Press the [F] key to save the setting and proceed to the next function item. Press the [S] key to save the setting, complete the function setting mode and return to measuring mode.</p>

#### Function setting using the arrow keys

Instead of the [Zero/Tare] key and the [F] key, the arrow keys can also be used to switch between the function items or setting values.

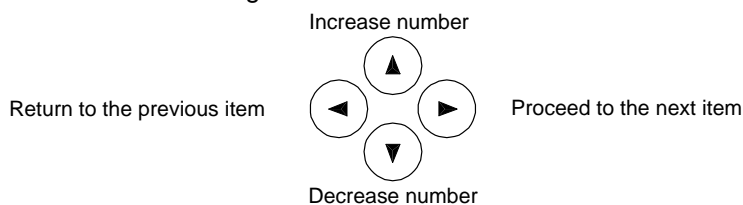

## 5.1.2 Description of Basic Functions

\*1 <2b. r.o.c.> is for optional relay contact output. Set it to "1" when the optional relay contact output is not used.

\*2 "1" and "2" of <7. CA.> are not available for models without internal calibration weight.

Reference

\*3 When <E3. P.F.> (Output language) is set to "2" (Japanese), <64. d.L.> (data length) is fixed to "8" (8 bits).

\*4 When <6. I.F.> (Interface) is set to "41" or "42", <66. n.u.> (Unused high order digits) is fixed to "0" (Embed space (20H) (Leading zero suppress)).

\*5 <d. Ad.C.> (Advice CAL) is not available for models without internal calibration weight.

☆: default factory settings

Item		Set value		Description	
Measuring mode		1.	SEt.	☆1	Weighing mode
				2	Countin mode
				3	Percentage mode
				4	Multiplied by coefficient mode
				5	Specific gravity mode
				6	Statistics mode
Displayed when <1. SEt.> (Measuring Mode) is set to "5" (Specific gravity mode).	Media	11.	MEd.	☆0	Water
				1	Any liquid other than water
	Output data	12.	d.o.d.	☆0	Only specific gravity of the sample is output
				1	Specific gravity of the sample, weight of the sample, and water temperature or the specific gravity of the medium liquid are output
	Auto output	13.	A.o.	☆0	Disabled (Manual output by [Output] key)
				1	Enabled (Automatic output each time a specific gravity measurement is completed)

☆: default factory settings

Item		Set value		Description	
Addition function and Comparator function		2. SEL	☆0	Disabled	
			1	Addition function enabled	
			2	Comparator function enabled	
			3	Addition function and comparator function enabled	
Displayed when the comparator function is enabled by setting <2. SEL.> to "2" or "3".	Judgement condition	21. Co.	☆1	Always judge (even when the balance is unstable).	
			2	Judge only when the balance is stable.	
	Judgement range	22. Li.	0	Over +5 divisions	
			☆1	Entire area	
	Number of thresholds		1	1 (Classifies into 2 ranks "OK" and "LO")	
		☆2	2 (Classifies into 3 ranks "HI", "OK" and "LO")		
		3	3 (Classifies into 4 ranks)		
		4	4 (Classifies into 5 ranks)		
	Judgement method	24. tyP.	☆1	Judge by absolute values.	
			2	Judge by deviation values.	
	Buzzer for rank 1	25. bu.1	☆0	Disabled	
			1	Enabled	
	Buzzer for rank 2	26. bu.2	☆0	Disabled	
			1	Enabled	
Buzzer for rank 3	27. bu.3	☆0	Disabled		
		1	Enabled		
Buzzer for rank 4	28. bu.4	☆0	Disabled		
		1	Enabled		
Buzzer for rank 5	29. bu.5	☆0	Disabled		
		1	Enabled		
How to indicate results	2A. LG.	☆1	Pointer form.		
		2	Bar graph form (Enabled only when <23. Pi.> is set to "2")		
Relay output control *1	2b. r.o.c.	☆1	Output all the time		
		2	Controlled by external contact input		
Displayed when the addition function is enabled by setting <2. SEL.> to "1" or "3".	Addition method	2C. Ad.M.	☆1	Cumulate	
			2	Net addition	
Auto zero tracking	3. A.0	0	Disabled		
		☆1	Enabled		
Stability judgment	4. S.d.	1	Wide (Mild)		
		☆2	↓		
		3	Narrow (Strict)		
		4			
Response speed	5. rE.	0	Sensitive mode		
		1			
		2	Fast		
		☆3	↓		
		4	Slow		
		5			
				Automatically adjust slight deviation of the zero-point.	

☆: default factory settings

Item		Set value	Description		
Interface		6. I.F.	0	Stop input/output	
			1	6-digit numeric format	
			2	7-digit numeric format	
			3	Extended 7-digit numeric format	
			4	Special formats	
			41	Special format 1	Displayed when <6. I.F.> is set to "4".
			42	Special format 2	
			☆5	CBM format	
Displayed when <6. I.F.> is set to "1", "2", "3", "41", "42" or "5".	Output control	61. o.c.	0	Stop output.	
			1	Output continuously at all times.	
			2	Output continuously if stable (Stop output if unstable).	
			3	Output once by pressing [Output] key (Irrespective of whether the balance is stable or not).	
			4	Output once when the balance is loaded and stabilised. The next output for another sample loading is executed once the indication becomes stabilised at less than or equal to zero by unloading and zero-point adjustment.	
			5	Output once every time when the balance reaches stable (Stop output at unstable times).	
			6	Output continuously at unstable times and output once every time when the balance reaches stable.	
			☆7	Output once after [Output] key is pressed and the balance reaches stable.	
			A	Output at every pre-set time interval.	
			b	Output at every pre-set time interval when the balance is stable (Stop output when the balance is unstable).	
	Baud rate	62. b.L.	☆1	1200 bps	
			2	2400 bps	
			3	4800 bps	
			4	9600 bps	
			5	19200 bps	
	Displayed when <6. I.F.> is set to "2", "3", "41", "42" or "5".	Parity	63. PA.	☆0	None
				1	Odd
				2	Even
Displayed when <6. I.F.> is set to "3", "41", "42" or "5".	Data length *3	64. d.L.	7	7 bits	
			☆8	8 bits	
	Stop bits	65. St.	1	1 bit	
			☆2	2 bits	
Displayed when <6. I.F.> is set to "1", "2", "3", "41", "42" or "5".	Unused high order digits *4	66. n.u.	☆0	Embed 0 (30H) (Leading zero padding)	
			1	Embed space (20H) (Leading zero suppress)	
	Response command format	67. r.ES.	☆1	A00/Exx format	
			2	ACK/NAK format	

☆: default factory settings

☆i: default factory settings for models with internal calibration weight

☆ii: default factory settings for models without internal calibration weight

Item	Set value		Description		
Calibration mode evoked by the [Cal] key *2	7.	CA.	0	Disable the calibration	
			☆i 1	Span adjustment with internal calibration weight (Semi-automatic span adjustment)	
			2	Span test with internal calibration weight	
			☆ii 3	Span adjustment with external weight	
			4	Span test with external weight	
Bar graph	8.	b.G.	0	No display	
			☆1	Displays the bar graph	
-	9.	A.P.	0	This item is not valid.	
			☆1		
Auto sleep	A.	A.S.	0	Disabled	
			☆1	Enabled. The balance goes into sleep mode 3 minutes later when the balance is in measuring mode, there is no load on the balance and the indication is stable.	
Weighing unit assigned to "Unit A"	b1.	u.A	☆1	gram	
			2	kilogram	
			4	carat	
			5	ounce	
			6	pound	
			7	troy ounce	
			8	pennyweight	
			9	grain	
			A	tael troy (Hong Kong)	
			b	tahil (Singapore / Malaysia)	
			C	tael (Taiwan)	
			d	momme	
			E	tola (India)	
Readability at "Unit A"	b2.	d.A	☆1		
			2		Fine
			3		↓
			4		Rough
			5		
Weighing unit assigned to "Unit B"	b3.	u.b	☆0	None	
			1	gram	
			2	kilogram	
			4	carat	
			5	ounce	
			6	pound	
			7	troy ounce	
			8	pennyweight	
			9	grain	
			A	tael troy (Hong Kong)	
			b	tahil (Singapore / Malaysia)	
			C	tael (Taiwan)	
			d	Momme	
E	tola (India)				
Readability at "Unit B"	b4.	d.b	☆1		
			2		Fine
			3		↓
			4		Rough
			5		
Advice CAL *5	d.	Ad.C.	☆ii 0	Disabled	
			☆i 1	Enabled	

Displayed when < b3. u.b> is set to other than "0".

☆: default factory settings

Item		Set value		Description	
ISO/GLP/GMP settings		E. GLP	☆0	Disabled	
			1	Enabled	
Displayed and activated when <E. GLP> is set to "1".	Output of span adjustment / test results	E1. out	0	Disabled	
			☆1	Enabled	
	ISO/GLP/GMP form output	E2. od.	☆0	Disabled	
			1	Enabled	
	Output language *3	E3. P.F.	☆1	English	
			2	Japanese (Katakana)	
Date Display		F. dAtE	1	Output in Year-Month-Day format.	
			2	Output in Month-Day-Year format.	
			☆3	Output in Day-Month-Year format.	
Time Stamp Output		G. t.o.	☆0	Disabled	
			1	Outputs time together with measurement data.	
Stability Waiting		H. tA.	1	Disabled	
			☆2	Enabled	
Power-on Tare Recall Function		J. tArE	☆0	Disabled	
			1	Enabled	
Direct Start		L. d.St.	☆0	The balance goes into the standby mode when the AC adapter is plugged in.	
			1	The balance is turned on when the AC adapter is plugged in.	



## 5.2 Advanced Function Setting Mode

### 5.2.1 Launching of Advanced Functions

<p>1 Invoke the advanced function setting mode.</p>	<p>Press the [F] key while holding down the [Zero/Tare] key.</p> <p>When &lt;Func2&gt; is displayed, release the key.</p> <p>The advanced function setting mode is activated, and the first item, &lt;1. Id&gt; (Setup of ID No.) appears.</p>
---	--

### 5.2.2 Description of Advanced Functions

**Reference**

- <1. Id>, <2. O.M.P.> and <3. r.CA.> are reset to “0” each time they are invoked.
- <3. r.CA.> is available only on models with internal calibration weight.

☆: default factory settings

Item	Set Value	Description
Setup of ID No.	1. Id	☆0 Not execute
		1 Execute
Setup of instrumental error of the external calibration weight	2. o.M.P.	☆0 Not execute
		1 Execute
Calibration of Built-in Weight	3. r.CA.	☆0 Not execute
		1 Execute
Adoption of the entered instrumental error of the external calibration weight	4. M.E.H.	☆0 Not adopt
		1 Adopt the instrumental error of the weight at the the span adjustment or span test with external calibration weight.

## 6 Measuring Modes and Functions

There are 6 measuring modes: weighing mode, counting mode, percentage mode, multiplied by coefficient mode, specific gravity mode, and statistics mode. Weighing mode, counting mode, percentage mode, and multiplied by coefficient mode support the addition function and the comparator function.

In each measuring mode, pressing the [F] key can toggle the display. Depending on the measuring mode, the display switching and enabled functions differ as follows:

Measuring Mode	Display switched by the [F] key			Addition function	Comparator function	Remarks
	Switching order	Displayed value	Displayed sign			
Weighing mode	1	Net weight in unit A	Net (When tare is subtracted)	x	x	
	2	Gross weight in unit A	B/G	-	-	
	3	Net weight in unit B	Net (When tare is subtracted)	-	-	
	4	Total of weight in unit A	$\Sigma$	Total value indication	-	Displayed only when addition function is activated
Counting mode	1	Counting	Net (When tare is subtracted), Pcs	x	x	
	2	Total of counting	Pcs, $\Sigma$	Total value indication	-	Displayed only when addition function is activated
	3	Unit weight (in unit A)	Pcs	-	-	
	4	Net weight in unit A	Net (When tare is subtracted)	-	-	
Percentage mode	1	Percentage	Net (When tare is subtracted), %	x	x	
	2	Total of percentage	%, $\Sigma$	Total value indication	-	Displayed only when addition function is activated
	3	Net weight in unit A	Net (When tare is subtracted)	-	-	
Multiplied by coefficient mode	1	Weight value multiplied by a predetermined coefficient value	#	x	x	
	2	Total of the multiplied value	#, $\Sigma$	-	-	
	3	Net weight in unit A	Net (When tare is subtracted)	-	-	
Specific gravity mode	1	Specific gravity	$d$	-	-	The weighing unit is fixed to "gram".
Statistics mode	1	Net weight in grams	$st$	-	-	The weighing unit is fixed to "gram".
	2	Statistical calculation results	$st$	-	-	

**Reference**

Various weighing unit can be assigned for default unit for weighing (Unit A) by <b1. u.A> of the basic function setting mode. Additional weighing unit can be assigned by <b3. u.b> as a collateral unit (Unit B) that can be switched to by the [F] key in the weighing mode.

## 6.1 Weighing Mode

By default, the balance is set to weighing mode. To return to weighing mode from other measuring modes, use the following operation:

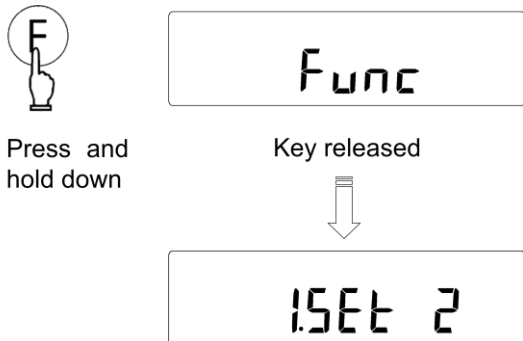
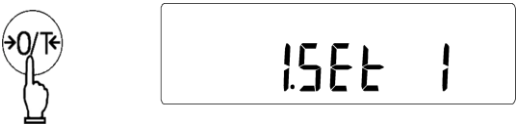
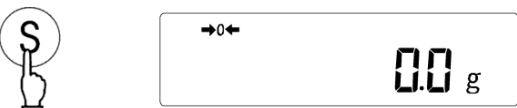
<p>1 Launch the basic function setting mode.</p>  <p>Press and hold down</p> <p>Key released</p>	<p>Press and hold down the [F] key. After &lt;Func&gt; is displayed, release the key. The function setting item &lt;1. SEt.&gt; is displayed.</p>
<p>2 Select "Weighing mode".</p>  <p>→0/T←</p>	<p>Press the [Zero/Tare] key several times to select "1".</p>
<p>3 Complete the setting of functions.</p>  <p>→0←</p> <p>0.0 g</p>	<p>Press the [S] key. The "Weighing mode" is activated and the display shows the sample's weight.</p>





## 6.2 Counting Mode

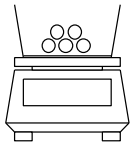
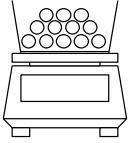

Counting mode can count the number of items by placing the items for which sampling has been completed on the balance and dividing the total weight of those items by the recorded unit weight.



In the sampling carried out prior to counting, a specified number of samples are first placed on the balance and the weight is captured. The balance then automatically calculates and stores the unit weight.

<p>Sampling</p>  $\frac{\text{Weight}}{\text{Number of samples}} = \frac{10 \text{ g}}{10 \text{ pieces}} = 1 \text{ g}$ <p>= Sample unit weight</p>	<p>Counting Pieces</p>  $\frac{\text{Total weight}}{\text{Sample unit weight}} = \frac{500 \text{ g}}{1 \text{ g}} = 500 \text{ pcs.}$ <p>= Measured number of samples</p>
---	--

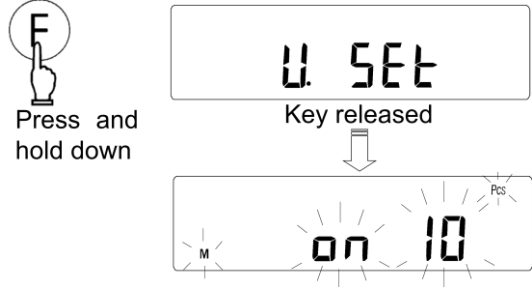
The balance calculates the sample's unit weight using the automatic memory update method: First, place a set number of samples. Next, place an appropriate number of additional samples, up to two times the set number. Then, the balance will automatically update the sample unit weight. Repeating this step allows accurate counting.

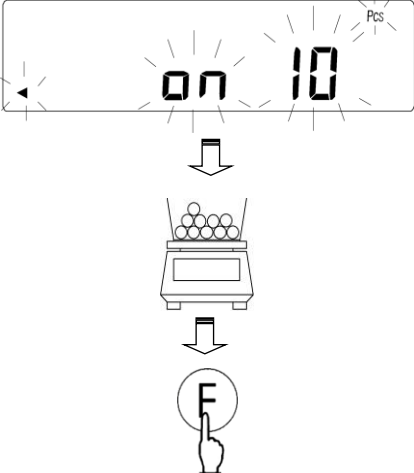
<p>1 Launch the basic function setting mode.</p> <div style="display: flex; align-items: center; justify-content: center; margin-top: 10px;">  <div style="border: 1px solid black; padding: 10px; text-align: center;"> <p style="font-size: 2em; margin: 0;">Func</p> <p style="margin: 0;">Key released</p>  </div> </div> <div style="border: 1px solid black; padding: 10px; text-align: center; margin-top: 10px; width: 150px;"> <p style="font-size: 1.5em; margin: 0;">1.5Et 1</p> </div>	<p>Press and hold down the [F] key. After &lt;Func&gt; is displayed, release the key. The function setting item &lt;1. SEt.&gt; is displayed.</p>
<p>2 Select "Counting mode".</p> <div style="display: flex; align-items: center; justify-content: center; margin-top: 10px;">  <div style="border: 1px solid black; padding: 10px; text-align: center;"> <p style="font-size: 1.5em; margin: 0;">1.5Et 2</p> </div> </div>	<p>Press the [Zero/Tare] key several times to select "2".</p>
<p>3 Complete the setting of functions.</p> <div style="display: flex; align-items: center; justify-content: center; margin-top: 10px;">  <div style="border: 1px solid black; padding: 10px; text-align: center;"> <p style="font-size: 1.5em; margin: 0;">→0←</p> <div style="display: flex; align-items: center; justify-content: center; margin-top: 5px;"> <div style="font-size: 2em; margin-right: 5px;">0</div> <div style="margin-right: 5px;">Pcs</div> </div> </div> </div>	<p>Press the [S] key. The "Counting mode" is activated.</p>

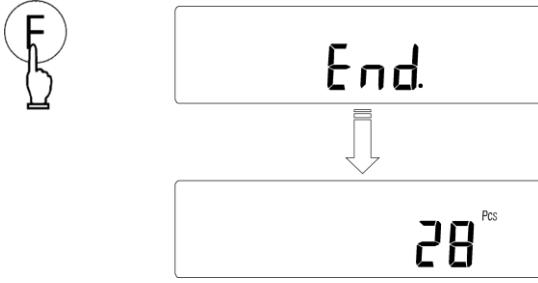
<p>4 Execute zero-point adjustment or tare subtraction as appropriate.</p> 	<p>Place the tare and press the [Zero/Tare] key to execute zero-point adjustment or tare subtraction.</p>
<p>5 Launch the sampling sequence.</p> 	<p>Press and hold down the [F] key for a few seconds. When the display indicates &lt;U. SEt.&gt;, release the key.</p> <p>The display flashes a number, such as &lt;on 10&gt;. This means that ten samples are to be loaded.</p> <hr/> <p><b>Reference</b></p> <p>Pressing the [Output] key can cancel the sampling sequence midway through.</p>
<p>6 Select the number of samples.</p> 	<p>If samples to be counted widely deviate in weight, or a higher measure of accuracy is desired, it is recommended that users change the sampling number to a larger value.</p> <p>Press the [Zero/Tare] key.</p> <p>Each press of the key changes the value on the right end. Select the desired value.</p> <p>If the sampling number need not be changed, go on to the next step.</p>
<p>7 Put samples on the balance.</p> 	<p>Put the displayed number of samples on the balance, and press the [F] key.</p> <p>The unit weight is calculated and stored, and the display then blinks &lt;10 Pcs&gt; and &lt;&lt;&gt;&gt;.</p>

<p>8 Put additional samples on the balance.</p> 	<p>Add a number of samples within twice the number of the previous storage, and wait until it is stable again. (The additional samples need not be counted.)</p> <p>The buzzer beeps, the unit weight is recalculated and the stored value is updated. Repeating this operation will improve the resolution of counting for more accurate measurements.</p>
<p>9 Complete the sampling.</p> 	<p>Press the [F] key. The buzzer beeps with the display of &lt;End.&gt;, the unit weight is saved and the display reverts to counting indication.</p>
<p>10 Load items to be counted.</p> 	<p>The number of items is indicated.</p>

<p>Note</p>	<ol style="list-style-type: none"> <li>(1) The &lt;Sub&gt; display that may be shown during a memory update of unit weight indicates that you added more than two times as many samples as the displayed number and thus the counting accuracy is low. Remove some number of samples once, and then gradually increase the number of samples to increase counting accuracy.</li> <li>(2) The &lt;Add&gt; display during a memory update of unit weight indicates that the number of samples you added is too small and the counting accuracy is low. Add samples until the &lt;Add&gt; display is turned off to improve the counting accuracy.</li> <li>(3) Even when &lt;Sub&gt; or &lt;Add&gt; indication is displayed, sampling is possible. In this case, however, counting accuracy is low, and a counting error may be caused.</li> <li>(4) When &lt;L-Err&gt; may be displayed to indicate that the unit weight is too small for the balance to count the samples. (Refer to “13 Specifications”.)</li> </ol>
-------------	--

## 6.3 Percentage Mode

With respect to the reference weight, the weight of a sample is shown in percentage. A reference sample weight can be set by weighing an actual sample or entering a value.

- (1) If <L-Err> appears briefly, it indicates that the weight of the reference sample is too light. For the minimum reference weight (MRW) that can be saved, please refer to “13 Specifications”.

\*If <L-Err> appears, reference value setting sequence is interrupted, and the data being processed will not be saved.

- (2) The readability is automatically selected, depending on the saved reference weight.







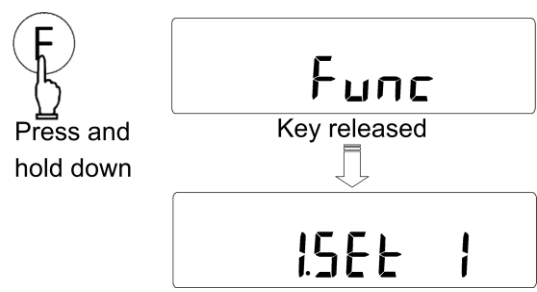
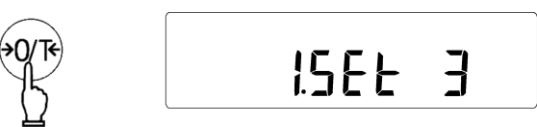
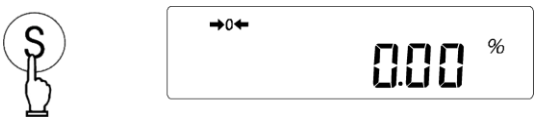

Reference

Readability	Range of Reference Weight
1%	$MRW \leq \text{Reference weight} < MRW \times 10$
0.1%	$MRW \times 10 \leq \text{Reference weight} < MRW \times 100$
0.01%	$MRW \times 100 \leq \text{Reference weight}$

\* MRW: Minimum reference weight

### 6.3.1 Set a reference weight by weighing an actual sample

<p>1 Launch the basic function setting mode.</p> 	<p>Press and hold down the [F] key. After &lt;Func&gt; is displayed, release the key. The function setting item &lt;1. SEt.&gt; is displayed.</p>
<p>2 Select “Percentage mode”.</p> 	<p>Press the [Zero/Tare] key several times to select “3”.</p>
<p>3 Complete the setting of functions.</p> 	<p>Press the [S] key. The “Percentage mode” is activated.</p>

<p>4 Execute zero-point adjustment or tare subtraction as appropriate.</p>  	<p>Place the tare and press the [Zero/Tare] key to execute zero-point adjustment or tare subtraction.</p>
<p>5 Launch the reference weight setting sequence.</p>   <p>Press and hold down</p> <p>Key released</p>	<p>Press and hold the [F] key. After &lt;P. SEt.&gt; is displayed, release the key. The previously-saved reference sample weight is displayed.</p> <hr/> <p><b>Reference</b></p> <p>Pressing the [Output] key can cancel the reference weight setting sequence midway through.</p> <hr/>
<p>6 Load the sample for reference and save the reference weight.</p>   	<p>Put the reference sample on the balance and then press the [F] key. The buzzer beeps with the display of &lt;End.&gt;, the reference weight is saved, and the display reverts to percentage indication.</p>
<p>7 Load a sample to be weighed.</p>  	<p>The balance indicates the percentage &lt;%&gt; of the loaded sample weight relative to the reference weight.</p>

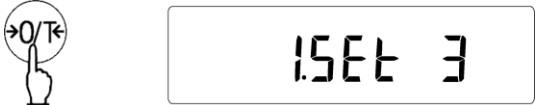
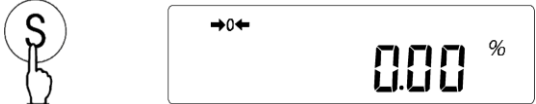
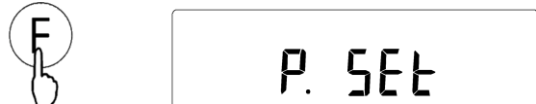

### 6.3.2 Set a reference weight by entering a value

<p>1 Launch the basic function setting mode.</p>  <p>Press and hold down</p>	<p>Press and hold down the [F] key. After &lt;Func&gt; is displayed, release the key. The function setting item &lt;1. SEt.&gt; is displayed.</p>
<p>2 Select "Percentage mode".</p> 	<p>Press the [Zero/Tare] key several times to select "3".</p>
<p>3 Complete the setting of functions.</p> 	<p>Press the [S] key. The "Percentage mode" is activated.</p>
<p>4 Launch the reference weight setting sequence.</p>  <p>Press and hold down</p>	<p>Press and hold the [F] key. After &lt;P. SEt.&gt; is displayed, release the key. The previously-saved reference sample weight is displayed.</p> <hr/> <p><b>Reference</b></p> <p>Pressing the [Output] key can cancel the reference weight setting sequence midway through.</p>

5 Enter the reference weight.



Numeric value input by **F** and **0/T** or 

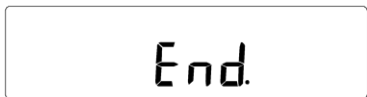

Enter the reference weight starting from a higher order digit with the following steps:

- 5-1. Press the [Zero/Tare] key. Zero blinks in the rightmost digit.
- 5-2. Select a number by pressing the [Zero/Tare] key, [ $\Delta$ ] key, or [ $\nabla$ ] key. Pressing the key switches between digits 0-9, minus sign, and decimal point.
- 5-3. Press the [F] key or [ $\blacktriangleright$ ] key to shift to the next lower order digit.
- 5-4. Set the reference weight by repeating steps 5-2 and 5-3. Pressing the [ $\blacktriangleleft$ ] key cancels the last input and returns to the previous digit entry. Pressing the [Output] key can cancel the setting.
- 5-5. Press the [S] key to save the reference weight.

The buzzer beeps with the display of <End.> and the display reverts to percentage indication.

**Note**

Entering a minus sign will result in an error.

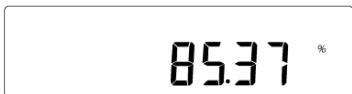

6 Load a sample to be weighed.



The balance indicates the percentage (%) of the loaded sample weight relative to the reference weight.

## 6.4 Multiplied by Coefficient mode

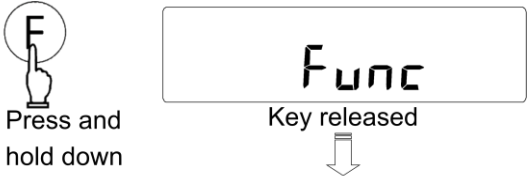
Measured weight is multiplied by the pre-set coefficient, and the result be displayed.

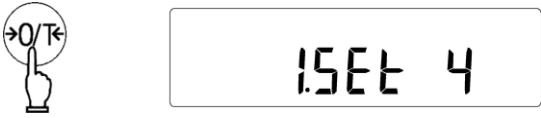
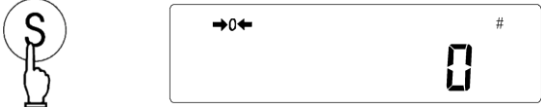
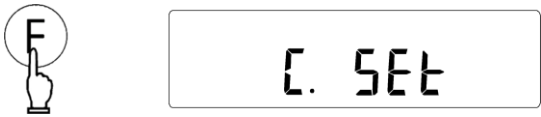
<p>1 Launch the basic function setting mode.</p>  <p>Press and hold down</p> <p>Key released</p> 	<p>Press and hold down the [F] key. After &lt;Func&gt; is displayed, release the key. The function setting item &lt;1. SEt.&gt; is displayed.</p>
<p>2 Select "Multiplied by Coefficient mode".</p> 	<p>Press the [Zero/Tare] key several times to select "4".</p>
<p>3 Complete the setting of functions.</p> 	<p>Press the [S] key. The "Multiplied by Coefficient mode" is activated and &lt;#&gt; is displayed.</p>
<p>4 Launch the coefficient setting sequence.</p>  <p>Press and hold down</p> <p>Key released</p>	<p>Press and hold the [F] key. After &lt;C. SEt.&gt; is displayed, release the key. The previously-saved coefficient is displayed.</p> <hr/> <p><b>Reference</b></p> <p>Pressing the [Output] key can cancel the coefficient setting sequence midway through.</p> <hr/>

5 Enter the coefficient.



Numeric value input by **F** and **Zero/Tare** or **Left/Right** or **Up/Down**

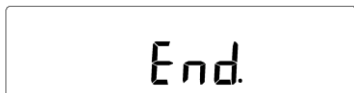

Enter the coefficient starting from a higher order digit with the following steps:

- 5-1. Press the [Zero/Tare] key.  
Zero blinks in the rightmost digit.
- 5-2. Select a number by pressing the [Zero/Tare] key, [**▲**] key, or [**▼**] key.  
Pressing the key switches between digits 0-9, minus sign, and decimal point.
- 5-3. Press the [**F**] key or [**▶**] key to shift to the next lower order digit.
- 5-4. Set the reference weight by repeating steps 5-2 and 5-3.  
Pressing the [**◀**] key cancels the last input and returns to the previous digit entry.  
  
Pressing the [Output] key can cancel the setting.
- 5-5. Press the [**S**] key to save the reference weight.

The buzzer beeps with the display of <End.> and the display reverts to multiplied value indication.

6 Load a sample to be measured.



The balance indicates the value calculated by multiplying the weight value by the coefficient.





## 6.5 Specific Gravity mode





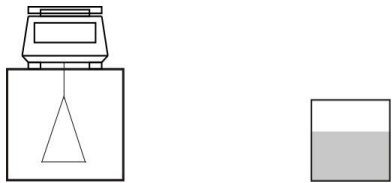
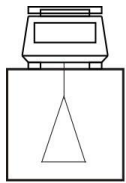





In the specific gravity mode, the ratio of the density of a substance to the density of water at its densest (4 °C) for liquids is calculated.





Prepare the equipment — a hanger fitting option for models with a capacity of 1200 g to 15 kg, a water tank, hanging string/wire, net/basket for placing the sample, thermometer etc.— in accordance with the samples to be measured.

### 6.5.1 Measurement procedures for specific gravity

<div style="border: 1px solid black; border-radius: 10px; padding: 5px; display: inline-block;">Note</div>	<p>(1) Be careful that the cage does not touch the container.</p> <p>(2) Using smaller size samples may result in inaccurate measurements. Use as large sample as possible.</p> <p>(3) The diameter of the wire to hang the cage may affect the measurement result especially when volume or specific gravity of the solid sample is small. Use as thin wire as possible.</p> <p>(4) Make sure that the sample is free from air bubbles.</p>
--	--

<p>1 Preparation for specific gravity measurements</p> <div style="text-align: center;">  </div> <div style="display: flex; justify-content: space-around; margin-top: 10px;"> <div style="text-align: center;">  <p>Hanging measurement</p> </div> <div style="text-align: center;">  <p>Container</p> </div> </div>	<p>Attach the hanger fitting option at first for models with a capacity of 1200 g to 15 kg. Put the balance on a pedestal and hang a cage or similar objects for placing the sample to be measured.</p> <p>As the sample weight is measured also in liquid, prepare a container whose size is enough to put the entire cage into the liquid.</p>
<p>2 Launch the basic function setting mode.</p> <div style="text-align: center;">  <p>Press and hold down</p> <div style="border: 1px solid black; padding: 10px; margin: 10px auto; width: 200px;"> <p style="text-align: center; font-size: 24px; font-weight: bold;">Func</p> <p style="text-align: center;">Key released</p> </div> <div style="text-align: center; margin-top: 10px;">  <div style="border: 1px solid black; padding: 10px; margin: 10px auto; width: 200px;"> <p style="text-align: center; font-size: 24px; font-weight: bold;">1.5Et 1</p> </div> </div> </div>	<p>Press and hold down the [F] key. After &lt;Func&gt; is displayed, release the key. The function setting item &lt;1. SEt.&gt; is displayed.</p>
<p>3 Select "Specific gravity mode".</p> <div style="text-align: center;">  <div style="border: 1px solid black; padding: 10px; margin: 10px auto; width: 200px;"> <p style="text-align: center; font-size: 24px; font-weight: bold;">1.5Et 5</p> </div> </div>	<p>Press the [Zero/Tare] key several times to select "5".</p>

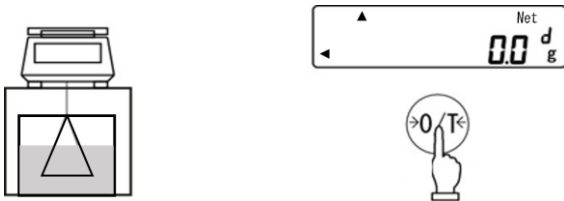
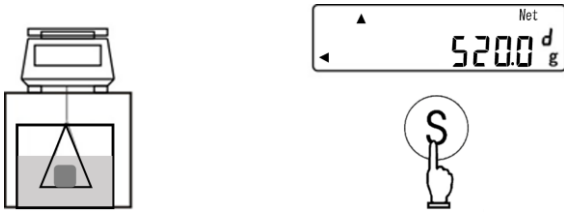
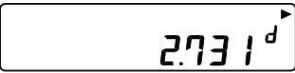
<p>4 Select the media liquid.</p>  	<p>Press the [F] key to go to &lt;11. MEd.&gt;. Press the [Zero/Tare] key to select "0" (water) or "1" (Liquid other than water) for the media liquid.</p>						
<p>5 Complete the setting of functions.</p>  	<p>Press the [S] key. The "Specific gravity mode" is activated.</p>						
<p>6 Launch the setting mode to input the temperature of the water or the specific gravity of the media liquid.</p>   <p>Press and hold down</p>	<p>Press and hold down the [Zero/Tare] key to launch the setting mode and then enter the water temperature or specific gravity of the liquid other than water. If the media liquid is water, &lt;dt&gt; is displayed on the right side of the display. Otherwise, &lt;d ▶&gt; will be indicated instead.</p>						
<p>7 Enter the value.</p>   <p>Numeric value input by (F) and (0/T) or </p>  	<p>Enter the water temperature or specific gravity of the liquid starting from a higher order digit with the following steps:</p> <p>7-1. Press the [Zero/Tare] key. Zero blinks in the rightmost digit.</p> <p>7-2. Select a number by pressing the [Zero/Tare] key, [▲] key, or [▼] key. Pressing the key switches between digits 0-9, minus sign, and decimal point.</p> <p>7-3. Press the [F] key or [▶] key to shift to the next lower order digit.</p> <p>7-4. Set the water temperature by repeating steps 7-2 and 7-3. Pressing the [◀] key cancels the last input and returns to the previous digit entry. Pressing the [Output] key can cancel the setting.</p> <p>7-5. Press the [S] key to save the value.</p> <hr/> <p><b>Reference</b></p> <p>- The acceptable range of numeric entry is specified as follows:</p> <table border="1" data-bbox="747 1439 1200 1613"> <thead> <tr> <th>Input data</th> <th>Range</th> </tr> </thead> <tbody> <tr> <td>Water temperature</td> <td>0.0 to 99.9 °C</td> </tr> <tr> <td>Specific gravity of the liquid other than water</td> <td>0.0001 to 9.9999</td> </tr> </tbody> </table> <p>Do not enter a minus sign, otherwise the water temperature or the specific gravity of the liquid will not be reflected correctly.</p> <p>- The value set is held even after the power is turned off.</p>	Input data	Range	Water temperature	0.0 to 99.9 °C	Specific gravity of the liquid other than water	0.0001 to 9.9999
Input data	Range						
Water temperature	0.0 to 99.9 °C						
Specific gravity of the liquid other than water	0.0001 to 9.9999						

<p>8 Hang only the cage and reset the display to 0.</p> 	<p>Press the [Zero/Tare] key with only the cage hung to reset the display to zero.</p>
<p>9 Measure the weight of the sample in the air.</p> 	<p>Measure the weight of the sample put in the cage or on the weighing pan, in the air. After the weight display is stable, press the [S] key to capture the weight. When the weight is entered, &lt; ◀ &gt; is displayed in the bottom left of the display and &lt; ▲ &gt; is shown in the top left part of the display.</p> <hr/> <p><b>Reference</b></p> <p>Pressing the [Output] key after entering the sample weight in the air will clear the weight value entered.</p>
<p>10 Submerge only the hanging cage and set to zero.</p> 	<p>Before the measurement in water, submerge only the cage and press the [Zero/Tare] key to set the indication to zero.</p>
<p>11 Measure the weight of the sample in the media liquid.</p>  	<p>Put the sample on the hanging cage and submerge the entire volume. After the weight display is stable, press the [S] key to capture the weight. Then the specific gravity of the sample is calculated and displayed with &lt; ▶ &gt; symbol.</p>
<p>12 Terminate the specific gravity measurement sequence.</p> 	<p>Press the [S] key to terminate the current sequence and move to the next sequence.</p>

## 6.5.2 Specific gravity measurement data output

(1) Output when specific gravity is displayed

Press [Output] key to output the specific gravity measurement result.

Auto output can also be selected by <13. A.o.>.

(2) Output format of the specific gravity measurement result

The followings show the output example when <12. d.o.d.> is set to "1". When

<12. d.o.d.> is set to "0", only the sample specific gravity is output.

Language selection between English and Japanese for output is made by <E3. P.F.> (output language).

1) When water is selected

English

	1	2	3	4	5	6	7	8	9	10	11	12	13	14	15
1	D	E	N	S	I	T	Y		S	O	L	I	D		
2								x	x	.	x	x	x		
3	S	A	M	P	L	E		W	E	I	G	H	T		
4				x	x	x	x	x	.	x	x	x		g	
5	T	E	M	P	E	R	A	T	U	R	E		N	O	W
6				x	x	x	x	x	x	.	x			C	
7															

← Sample specific gravity

← Sample weight

← Water temperature

2) When liquid other than water is selected

English

	1	2	3	4	5	6	7	8	9	10	11	12	13	14	15
1	D	E	N	S	I	T	Y		S	O	L	I	D		
2								x	x	.	x	x	x		
3	S	A	M	P	L	E		W	E	I	G	H	T		
4				x	x	x	x	x	.	x	x	x		g	
5	D	E	N	S	I	T	Y		M	E	D	.	L	I	Q
6				x	x	x	x	.	x	x	x	x			
7															

← Sample specific gravity

← Sample weight

← Specific gravity of media liquid

Reference

- The unit notation " °C " (degree Celsius) is replaced by the letter "C".

- The character code of Japanese is JIS X 0201.

## 6.6 Statistics Mode

The statistics mode collects weight data and indicates the maximum, average, and other statistical values.

Reference



- The measurement unit is fixed to gram, and the readability is fixed to the minimum value.

- The statistical calculation result is cleared when the function <1. SEt.> is set to a value other than "6", or the power is turned off.

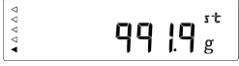

### 6.6.1 Calculation items

The statistics mode calculates and displays the following items:

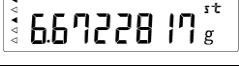
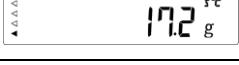
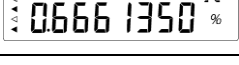
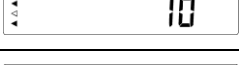
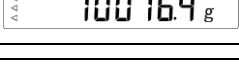
Calculation item	Formula ( $x_i$ : $i$ -th measured value $N$ : Sample size $x_{MAX}$ : Maximum value $x_{MIN}$ : Minimum value)	Display example (◀: Lit. ◁: Not lit.)
Maximum value	$x_{MAX}$	
Minimum value	$x_{MIN}$	
Average value	$\frac{1}{N} \sum_{i=1}^N x_i$	
Square root of the unbiased sample variance	$\sqrt{\frac{N \sum_{i=1}^N (x_i)^2 - (\sum_{i=1}^N x_i)^2}{N(N-1)}}$	
Range	$x_{MAX} - x_{MIN}$	
CV	$\frac{\text{Square root of the unbiased sample variance}}{\text{Average value}} \times 100(\%)$	
Sample size (Number of data points)	$N$	
Total	$\sum_{i=1}^N x_i$	

- The square root of the unbiased sample variance is not a sample standard deviation nor an unbiased estimator of the population standard deviation.

To obtain a sample standard deviation, use the following formula:

$$\text{Sample standard deviation} = \sqrt{\frac{1}{N} \sum_{i=1}^N (x_i)^2 - \left(\frac{\sum_{i=1}^N x_i}{N}\right)^2}$$

To obtain an unbiased estimator of the population standard deviation, use the following formula:

$$\text{Unbiased estimator of the population standard deviation} = \sqrt{\frac{N-1}{2} \frac{\Gamma\left(\frac{N-1}{2}\right)}{\Gamma\left(\frac{N}{2}\right)} \sqrt{\frac{N \sum_{i=1}^N (x_i)^2 - (\sum_{i=1}^N x_i)^2}{N(N-1)}}$$

**Reference**

If the distribution is normal and the sample size is sufficiently large, the following approximate formula can be used instead:

$$\text{Unbiased estimator of the population standard deviation} \approx \sqrt{\frac{N \sum_{i=1}^N (x_i)^2 - (\sum_{i=1}^N x_i)^2}{N(N-1.5)}}$$

- CV is not a coefficient of variation.



To obtain a coefficient of variation regarding sample, use the following formula:











$$\text{Coefficient of variation of the sample} = \frac{\text{Sample standard deviation}}{\text{Average value}} \times 100(\%)$$

To obtain a coefficient of variation regarding population, use the following formula:

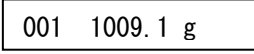
$$\text{Unbiased estimator of the coefficient of variation of the population} = \frac{\text{Unbiased estimator of the population standard deviation}}{\text{Average value}} \times 100(\%)$$

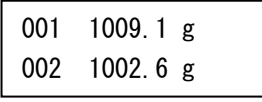
## 6.6.2 Operational procedure

<p>1 Launch the basic function setting mode.</p>  <p>Press and hold down</p>	<p>Press and hold down the [F] key. After &lt;Func&gt; is displayed, release the key. The function setting item &lt;1. SEt.&gt; is displayed.</p>
<p>2 Select "Statistics mode".</p> 	<p>Press the [Zero/Tare] key several times to select "6".</p>
<p>3 Select the data capturing method.</p> 	<p>Press the [F] key several times to go to &lt;6. I.F.&gt; and press the [Zero/Tare] key to select the output format. Then press the [F] key to go to &lt;61. o.c.&gt; and press the [Zero/Tare] key to select "4" or "7".</p> <p>"4": The data is automatically captured once after a sample is loaded and the balance reaches stable.</p> <p>"7": The data is captured once after the [Output] key is pressed and the balance reaches stable.</p> <hr/> <p><b>Reference</b></p> <ul style="list-style-type: none"> <li>- The output settings are linked to the data capture settings set above.</li> <li>- If &lt;6. I.F.&gt; has been set to "0", it will automatically switch to "1" when statistic mode is activated.</li> <li>- If &lt;61. o.c.&gt; has been set to other than "4" or "7", it will automatically switch to "7" when statistic mode is activated.</li> </ul>

<p>4 Complete the setting of functions.</p>  	<p>Press the [S] key. The "Statistics mode" is activated.</p>
<p>5 Capture a data point.</p>   	<p>Place a sample on the balance. When &lt;61. o.c.&gt; is set to "7", press the [Output] key. &lt;←→&gt; is displayed briefly, and the data point is captured.</p>
<p>6 Capture the next data point.</p>   	<p>Remove the sample from the balance and ensure that "0" is displayed. Press the [Zero/Tare] key if necessary. Place another sample on the balance and repeat step 4 to collect the next data point. Repeat this process to correct data points.</p>
<p>7 Display the statistical calculation results.</p>  	<p>Press the [F] key to switch to the statistical calculation results display. Refer to "6.6.3 Statistical calculation result display" for the display switching by the operation keys.</p>
<p>8 Return to the measurement display.</p>  	<p>Press the [F] key to return to the measurement display.</p>

- (1) If the sample size (number of data points collected) exceeds 999, or the number of digits of the "SUM" value exceeds the maximum number of the digits that can be displayed, the <9-Err> is displayed, and the statistical calculation is cancelled. Delete the statistical calculation result.

**Reference**

- (2) When the statistical calculation result is displayed, the auto sleep function, input commands, and external tare subtraction/zero-point adjustment are not activated.
- (3) If the value of a data point is 0 g or less, <9-Err> is displayed and the data point is not collected.

### 6.6.3 Statistical calculation result display

The following briefly describes how the display is switched by the operation keys in the statistical calculation result display.

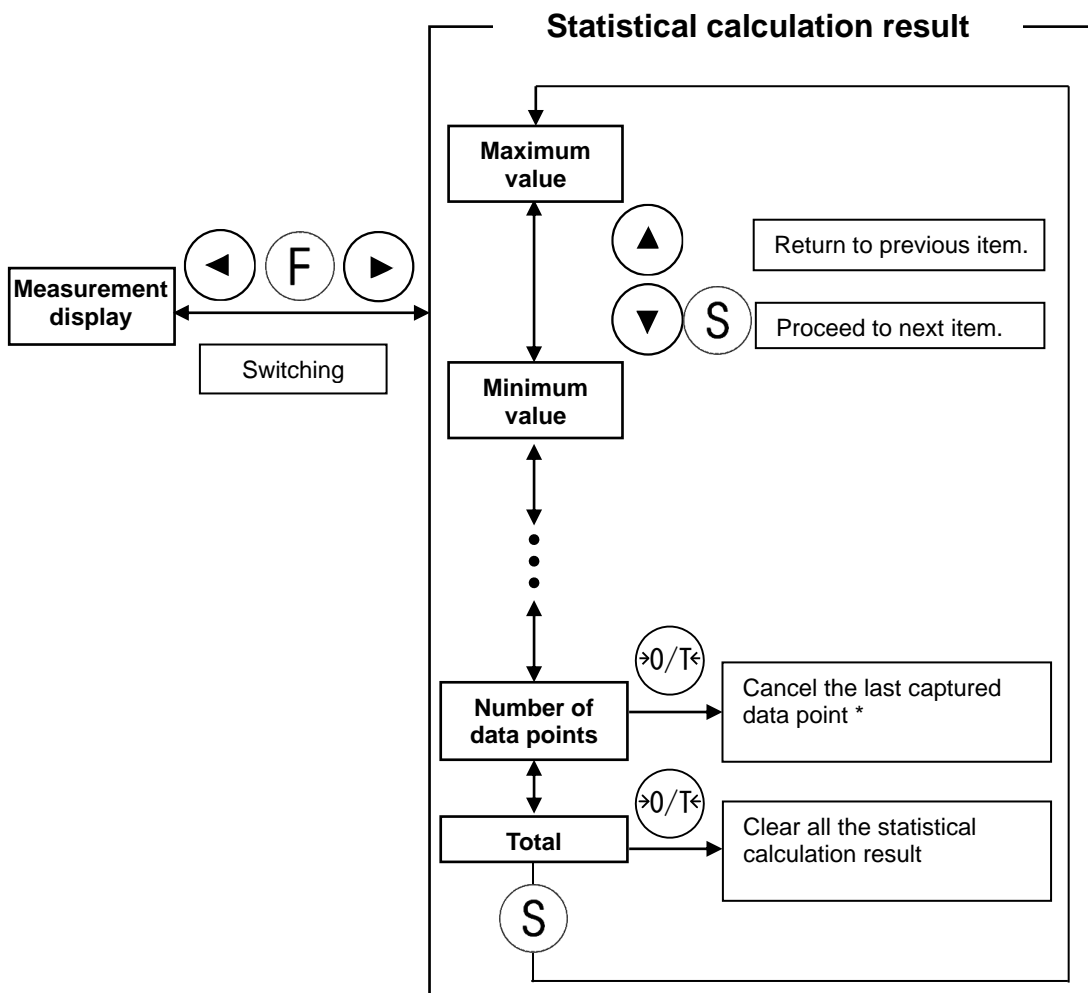

Refer to “6.6.1 Calculation items” for the statistical calculation result items.

\* The second last data point cannot be cancelled. If the [Zero/Tare] key is pressed again after the data point has been deleted, <8-Err> is displayed.



## 6.6.4 Outputting the statistical calculation results

A set of statistical calculation results can be output to a peripheral device connected to the balance.

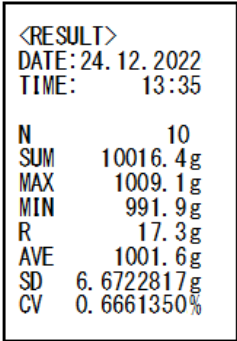
<p>1 Switch to the statistical calculation result display.</p>  	<p>Press the [F] key to switch to the statistical calculation result display.</p>
<p>2 Output the set of statistical calculation results.</p>  	<p>Press the [Output] key to output the set of statistical calculation results.</p>

### - Output data set

Item	Description
DATE:	Date (date of output)
TIME:	Time (time of output)
N	Sample size (Number of data points)
SUM	Total
MAX	Maximum value
MIN	Minimum value
R	Range (maximum value - minimum value)
AVE	Average value
SD	Square root of the unbiased sample variance
CV	Percentage of "Square root of the unbiased sample variance" relative to "Average value"

Message	Description
CANCEL	Last collected data point has been cancelled
ALLCLR	All statistical calculation results have been cleared

#### Reference

(1) Date format depends on the function setting of <F. dAtE>.

(2) Output language (English / Japanese) depends on the function setting of <G3. PF>.

## 6.7 Addition Function

Multiple samples are measured consecutively and the sum is displayed.





The addition function includes two methods:

- Cumulate: Method of weighing samples while replacing the samples to be weighed
- Net addition: Method of weighing samples to be weighed without replacing the samples

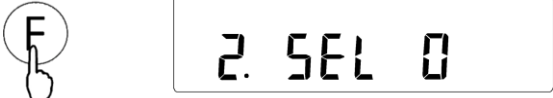
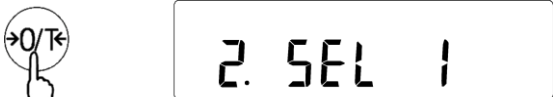

Reference

- The addition function can be used in the following measuring modes: weighing, counting, percentage, and multiplied by coefficient.
- The function item <H. tA.> (Stability waiting) can be used for turning ON/OFF the function to wait for stabilisation upon additions.

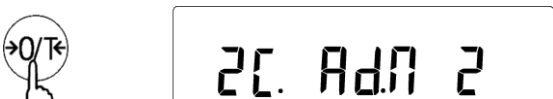
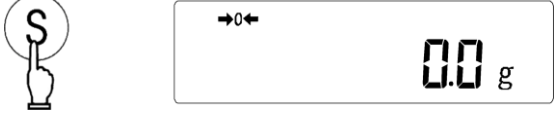

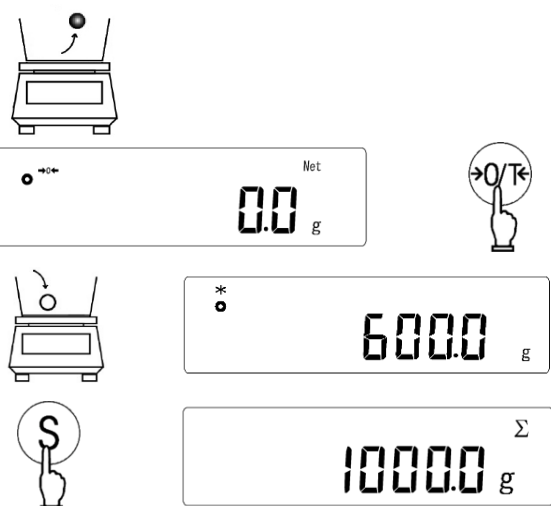
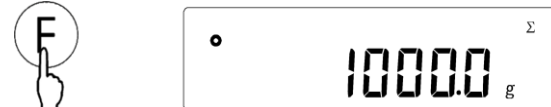
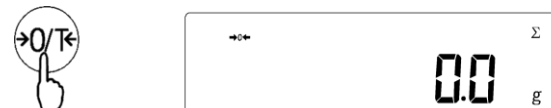

### 6.7.1 Addition Function Setting

<p>1 Launch the basic function setting mode.</p>  <p>Press and hold down</p> 	<p>Press and hold down the [F] key. After &lt;Func&gt; is displayed, release the key. The function setting item &lt;1. SEt.&gt; is displayed.</p>
<p>2 Select "Addition function".</p>  	<p>Press the [F] key several times to go to &lt;2. SEL&gt;. Then press the [Zero/Tare] key several times to select "1" or "3".</p> <ul style="list-style-type: none"> <li>"1": Addition function enabled</li> <li>"3": Addition function and comparator function enabled</li> </ul>
<p>3 Select the addition method.</p>  	<p>Press the [F] key several times to go to &lt;2C. Ad.M&gt;. Then press the [Zero/Tare] key several times to select "1" or "3".</p> <ul style="list-style-type: none"> <li>"1": Cumulate method</li> <li>"2": Net addition method</li> </ul>
<p>4 Complete the setting of functions.</p> 	<p>Press the [S] key to return to the measuring mode. The "Addition function" is activated.</p>

## 6.7.2 Cumulate Method Operation

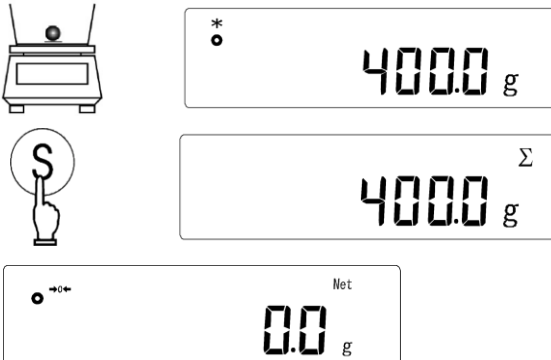
<p>1 Execute zero-point adjustment or tare subtraction as appropriate.</p> 	<p>Place the tare and press the [Zero/Tare] key to execute zero-point adjustment or tare subtraction.</p>
<p>2 Place the first sample.</p> 	<p>Place the first sample and press the [S] key after &lt;*&gt; and &lt;O&gt; is displayed. The weight of the first sample is captured and &lt;Σ&gt; is displayed for several seconds.</p>
<p>3 Reset the indication to zero and place another sample to be added</p> 	<p>Unload the first sample or press the [Zero/Tare] key to reset the indication to zero, and ensure that &lt;*&gt; sign disappears. Then place another sample to be added and press the [S] key after &lt;*&gt; and &lt;O&gt; is displayed. The weight of the additional sample is captured, and &lt;Σ&gt; and the total weight is displayed for several seconds. Repeat this operation to weigh all the samples to be summed.</p>
<p>4 Display the total weight.</p> 	<p>Press the [F] key several times until &lt;Σ&gt; appears. The total weight is displayed with &lt;Σ&gt; sign.</p>
<p>5 Clear the total weight.</p> 	<p>Press the [Zero/Tare] key at the total weight display to clear the total weight.</p>
<p><b>Note</b></p>	<p>&lt;t-Err&gt; is displayed when you press the [S] key while &lt;*&gt; is not displayed at steps 2 and 3.</p>

### 6.7.3 Net Addition Method Operation

<p>1 Execute zero-point adjustment or tare subtraction as appropriate.</p> 	<p>Place the tare and press the [Zero/Tare] key to execute zero-point adjustment or tare subtraction.</p>
<p>2 Place the first sample.</p> 	<p>Place the first sample and press the [S] key after &lt;*&gt; and &lt;O&gt; is displayed. The weight of the first sample is captured and &lt;Σ&gt; is displayed for several seconds. Then zero-point adjustment or tare subtraction is performed automatically.</p>
<p>3 Place another sample to be added.</p> 	<p>With the first sample remained to be loaded, place another sample to be added and press the [S] key after &lt;*&gt; and &lt;O&gt; is displayed. The weight of the additional sample is captured, and &lt;Σ&gt; and the total weight is displayed for several seconds. Repeat this operation to weigh all the samples to be summed.</p>
<p>4 Display the total weight.</p> 	<p>Press the [F] key several times until &lt;Σ&gt; appears. The total weight is displayed with &lt;Σ&gt; sign.</p>
<p>5 Clear the total weight.</p> 	<p>Press the [Zero/Tare] key at the total weight display to clear the total weight.</p>
<p>Note</p>	<p>&lt;t-Err&gt; is displayed when you press the [S] key while &lt;*&gt; is not displayed at steps 2 and 3.</p>



## 6.8 Comparator Function

The comparator function judges measured values based on pre-registered thresholds (limit values).

This function can be used in weighing mode, counting mode, and percentage mode.

### 6.8.1 Setting of the Comparator Function

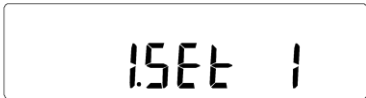
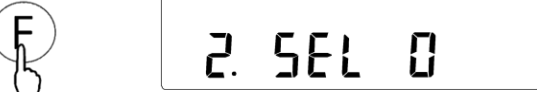
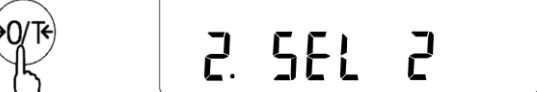
<p>1 Launch the basic function setting mode.</p>  <p>Press and hold down</p> <p>Key released</p> 	<p>Press and hold down the [F] key. After &lt;Func&gt; is displayed, release the key. The function setting item &lt;1. SEt.&gt; is displayed.</p>
<p>2 Select "Comparator function".</p>  	<p>Press the [F] key several times to go to &lt;2. SEL&gt;. Then press the [Zero/Tare] key several times to select "2" or "3".</p> <p>"2": Comparator function enabled  "3": Addition function and comparator function enabled</p>
<p>3 Select the judgement condition.</p>	<p>Press the [F] key to go to &lt;21. Co.&gt;. Then press the [Zero/Tare] key to select:</p> <p>"1": Always judge  "2": Judge only when the balance is stable</p>
<p>4 Select the judgement range.</p>	<p>Press the [F] key to go to &lt;22. Li.&gt;. Then press the [Zero/Tare] key to select:</p> <p>"1": Over +5 divisions  "2": Entire range</p>
<p>5 Select the number of thresholds</p>	<p>Press the [F] key to go to &lt;23. Pi.&gt;. Then press the [Zero/Tare] key to select:</p> <p>"1": 1 threshold is set. Classified as rank "ok" or "Lo".  "2": 2 thresholds are set. Classified as rank "Hi", "ok" or "Lo".  "3": 3 thresholds are set. Classified as one of ranks 1 to 4.  "4": 4 thresholds are set. Classified as one of ranks 1 to 5.</p>

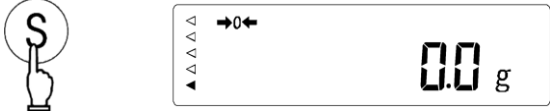
<p>6 Select the discriminant method</p>	<p>Press the [F] key to go to &lt;24. tyP.&gt;. Then press the [Zero/Tare] key to select:          "1": Judge by absolute values.          "2": Judge by deviation values.</p>
<p>7 Configure the buzzer settings</p>	<p>Press the [F] key to select from &lt;25. bu.1.&gt; to &lt;29. bu.5.&gt;. Then press the [Zero/Tare] key to select "0" (off) or "1" (on).          &lt;25. bu.1.&gt;: Buzzer for rank 1 or rank "Lo"          &lt;26. bu.2.&gt;: Buzzer for rank 2 or rank "ok"          &lt;27. bu.3.&gt;: Buzzer for rank 3 of rank "Hi"          &lt;28. bu.4.&gt;: Buzzer for rank 4          &lt;29. bu.5.&gt;: Buzzer for rank 5</p>
<p>8 Select the judgement result indication</p>	<p>Press the [F] key to go to &lt;2A. LG.&gt;. Then press the [Zero/Tare] key to select:          "1": Pointer form          "2": Bar graph form          (Available only when &lt;23. Pi.&gt; is set to "2".)</p>
<p>9 Select the relay output control</p>	<p>Press the [F] key to go to &lt;2B. r.o.c.&gt;. Then press the [Zero/Tare] key to select:          "1": Output all the time.          "2": Controlled by an external input command.</p> <hr/> <p><b>Reference</b></p> <p>This function is for balance with optional relay output.          When the balance is not equipped with the option, select "1".</p> <hr/>
<p>10 Complete the setting of functions.</p> 	<p>Press the [S] key to return to the measuring mode.          The "Comparator function" is activated.</p>

## 6.8.2 Configuration of the thresholds

The threshold setting depends on the discrimination method set in <24. tyP.>:

- (1) Judge by absolute values..... Specify threshold values directly.
- (2) Judge by deviation values ..... Specify the reference value then specify deviations with respect to the reference.

For example:

To set a lower limit of 970.0 g and an upper limit of 1050.0 g with respect to a reference weight of 1000.0 g, enter the thresholds as shown below:

	Reference Weight	Lower Limit	Upper Limit
Absolute weight	1000.0 g	970.0 g	1050.0 g
Judgment by absolute values	-	970.0 g	1050.0 g
Judgment by deviation values	1000.0 g	-30.0 g	50.0 g

Thresholds can be set in the following two ways:

- (1) Place actual samples on the balance
- (2) Enter values by key stroke

- (1) Once registered, the thresholds are retained even after the balance is turned off.
- (2) Thresholds can be registered for each measuring mode. However, thresholds of both absolute and deviation values cannot be saved in the same measuring mode. If the setting of <24. tyP.> (discriminant method) is switched, all the registered thresholds are reset to zero.
- (3) Thresholds and reference setting sequence can only be evoked in:
  - At weighing mode: Display of net weight in unit A
  - At counting mode: Display of counting
  - At percentage mode: Display of percentage

Reference

In other display, the interval time setting sequence is activated instead.

To switch the display, press the [F] key by referring to the table in "6 Measuring Modes and Functions".

- (4) If the thresholds entries are not lined up in the order of magnitude, all five < ◀ ▶ > indications will be lit simultaneously. Check the values and enter them again.
- (5) Pressing the [Output] key cancels the setting sequence.

<b>Hi</b>	◀-----	Rank 5:	4th threshold < Measured value
	◀-----	Rank 4:	3rd threshold ≤ Measured value < 4th threshold
<b>ok</b>	◀-----	Rank 3:	2nd threshold ≤ Measured value < 3rd threshold
	◀-----	Rank 2:	1st threshold ≤ Measured value < 2nd threshold
<b>Lo</b>	◀-----	Rank 1:	Measured value < 1st threshold

## 6.8.2.1 Judge by Absolute Values

(1) In the threshold setting screen, the < ◀ ▶ > symbol is displayed to identify the currently set threshold as follows:

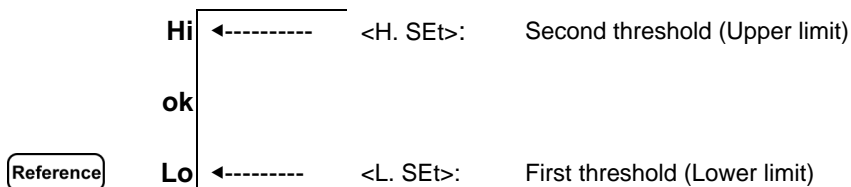

When <23. Pi.> (Number of thresholds) is set to "1" or "2":



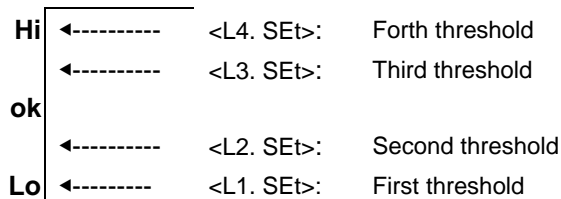

When <23. Pi.> (Number of thresholds) is set to "3" or "4":

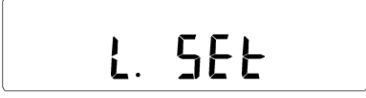
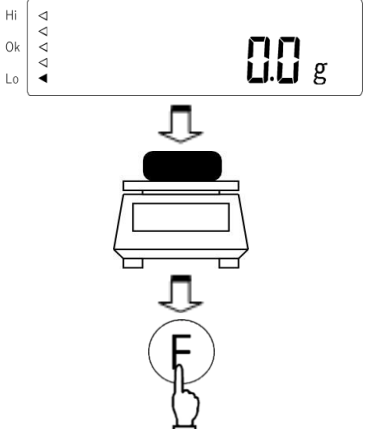

### 6.8.2.1.1 Set absolute value by placing actual sample on the balance

<p>1 Execute zero-point adjustment or tare subtraction as appropriate.</p>  	<p>Place the tare and press the [Zero/Tare] key to execute zero-point adjustment or tare subtraction.</p>
<p>2 Launch the thresholds setting sequence.</p>  <p>Press and hold down</p> 	<p>Press the [S] key for a few seconds. When the display indicates &lt;L. SEt&gt; or &lt;L1. SEt&gt;, release the key.</p>
<p>3 Set the thresholds.</p> 	<p>The current threshold is displayed together with the &lt; ◀ ▶ &gt; indicator on the left side of the display.</p> <p>To adopt the currently registered value and skip the input, press the [S] key.</p> <p>Place the sample for the first threshold on the balance and press the [F] key to capture the value.</p> <p>When the capturing is completed, the value is displayed for a while.</p> <p>Repeat this step until all the thresholds are registered.</p> <p>When all the thresholds are registered, the balance reverts to the measuring mode.</p>

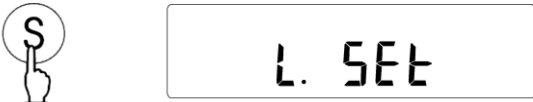
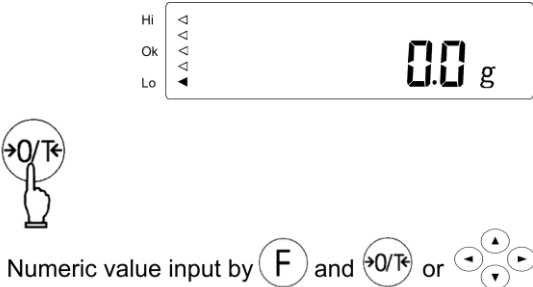
### 6.8.2.1.2 Set absolute value by key stroke

<p>1 Launch the thresholds setting sequence.</p>  <p>Press and hold down</p>	<p>Press the [S] key for a few seconds. When the display indicates &lt;L. SEt&gt; or &lt;L1. SEt&gt;, release the key.</p>
<p>2 Set the thresholds.</p>  <p>Numeric value input by <b>F</b> and <b>0/T</b> or </p>	<p>The current threshold is displayed together with the &lt; ◀ ▶ &gt; indicator on the left side of the display.</p> <p>Enter the threshold value starting from a higher order digit with the following steps:</p> <ul style="list-style-type: none"> <li>2-0. To adopt the currently registered value and skip the input, press the [S] key.</li> <li>2-1. Press the [Zero/Tare] key. Zero blinks in the rightmost digit.</li> <li>2-2. Select a number by pressing the [Zero/Tare] key, [▲] key, or [▼] key. Pressing the key switches between digits 0-9, minus sign, and decimal point.</li> <li>2-3. Press the [F] key or [▶] key to shift to the next lower order digit.</li> <li>2-4. Set the threshold by repeating steps 2-2 and 2-3. Pressing the [◀] key cancels the last input and returns to the previous digit entry.</li> <li>2-5. Press the [S] key to save the threshold. The buzzer beeps and the value is displayed for a while.</li> </ul> <p>Repeat the steps 2-0 to 2-5 above until all the thresholds are registered.</p> <p>When all the thresholds are registered, the balance reverts to the measuring mode.</p>

## 6.8.2.2 Judge by Deviation Values

(1) In the threshold setting screen, the <◀▶> symbol is displayed to identify the currently set threshold as follows:

When <23. Pi.> (Number of thresholds) is set to "1" or "2":



Hi	◀-----	<H. SEt>:	Second threshold (Upper deviation limit)
ok	◀-----	<r. SEt>:	Reference value
Lo	◀-----	<L. SEt>:	First threshold (Lower deviation limit)

Reference

When <23. Pi.> (Number of thresholds) is set to "3" or "4":

Hi	◀-----	<L4. SEt>:	Forth threshold
	◀-----	<L3. SEt>:	Third threshold
ok	◀-----	<r. SEt>:	Reference value
	◀-----	<L2. SEt>:	Second threshold
Lo	◀-----	<L1. SEt>:	First threshold

### 6.8.2.2.1 Set deviation value by placing actual sample on the balance

<p>1 Execute zero-point adjustment or tare subtraction as appropriate.</p> <div style="display: flex; align-items: center; margin-top: 10px;">  <div style="border: 1px solid black; padding: 5px; display: flex; align-items: center; justify-content: center;"> <span style="margin-right: 10px;">→0←</span> <div style="text-align: right; font-size: 24px; font-weight: bold;">0.0 g</div> </div> </div>	<p>Place the tare and press the [Zero/Tare] key to execute zero-point adjustment or tare subtraction.</p>
<p>2 Launch the reference value and thresholds setting sequence.</p> <div style="display: flex; align-items: center; margin-top: 10px;">  <div style="border: 1px solid black; padding: 5px; display: flex; align-items: center; justify-content: center;"> <div style="text-align: right; font-size: 24px; font-weight: bold;">r.SET</div> </div> </div> <p style="margin-top: 5px;">Press and hold down</p>	<p>Press the [S] key for a few seconds. When the display indicates &lt;r. SEt&gt;, release the key.</p> <p style="text-align: center; margin-top: 10px;">Key released</p>

3 Set the reference value.

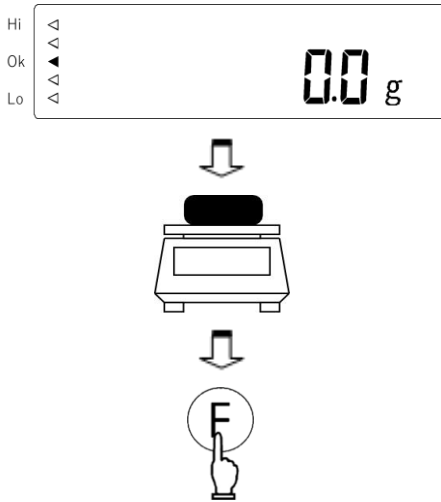

The current reference value is displayed together with the <◀▶> indicator next to "Ok".  
To adopt the currently registered value and skip the input, press the [S] key.

Place the sample for the reference value on the balance and press the [F] key to capture the value.

When the capturing is completed, the value is displayed for a while.

Once the reference value setting is completed, the sequence then moves on to the thresholds setting sequence.

4 Set the thresholds.

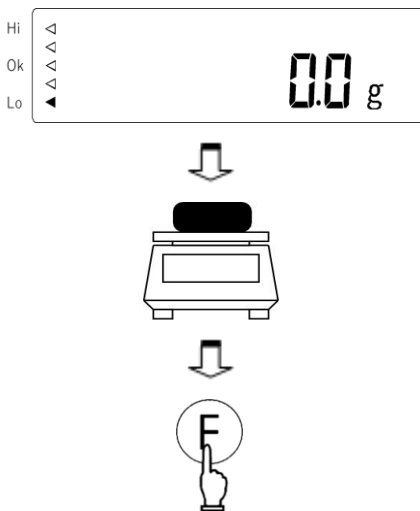

The current threshold is displayed together with the <◀▶> indicator on the left side of the display.

To adopt the currently registered value and skip the input, press the [S] key.

Place the sample with a weight corresponding to the weight that is deviated from the reference weight by the intended value, and then press the [F] key. The threshold is calculated and set automatically. When the capturing is completed, the value is displayed for a while.

Repeat this step until all the thresholds are registered.

When all the thresholds are registered, the balance reverts to the measuring mode.

### 6.8.2.2.2 Set deviation value by key stroke

1 Launch the reference value and thresholds setting sequence.



Press and hold down

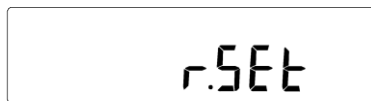

Key released

Press the [S] key for a few seconds. When the display indicates <r. SEt>, release the key.

2 Set the reference value.

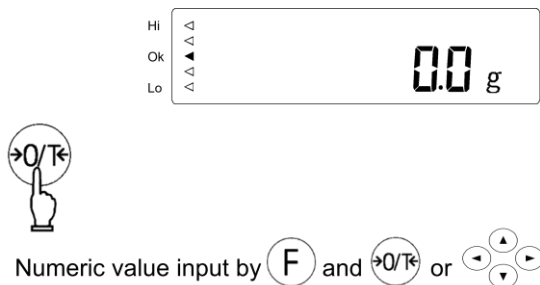

The current reference value is displayed together with the <◀▶> indicator next to "ok". To adopt the currently registered value and skip the input, press the [S] key.

Enter the reference value starting from a higher order digit with the following steps:

- 2-1. Press the [Zero/Tare] key.  
Zero blinks in the rightmost digit.
- 2-2. Select a number by pressing the [Zero/Tare] key, [▲] key, or [▼] key.  
Pressing the key switches between digits 0-9, minus sign, and decimal point.
- 2-3. Press the [F] key or [▶] key to shift to the next lower order digit.
- 2-4. Set the threshold by repeating steps 2-2 and 2-3.  
Pressing the [◀] key cancels the last input and returns to the previous digit entry.
- 2-5. Press the [S] key to save the reference  
The buzzer beeps and the value is displayed for a while.

Once the reference value setting is completed, the sequence then moves on to the thresholds setting sequence.

3 Set the thresholds.

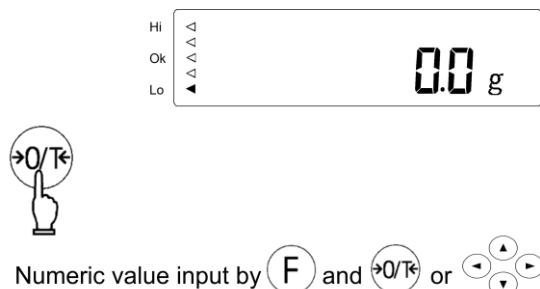

The current threshold is displayed together with the <◀▶> indicator on the left side of the display.

Enter the threshold value (deviation from the reference) starting from a higher order digit with the following steps:

- 3-0. To adopt the currently registered value and skip the input, press the [S] key.
- 3-1. Press the [Zero/Tare] key.  
Zero blinks in the rightmost digit.
- 3-2. Select a number by pressing the [Zero/Tare] key, [▲] key, or [▼] key.  
Pressing the key switches between digits 0-9, minus sign, and decimal point.
- 3-3. Press the [F] key or [▶] key to shift to the next lower order digit.
- 3-4. Set the threshold by repeating steps 3-2 and 3-3.  
Pressing the [◀] key cancels the last input and returns to the previous digit entry.
- 3-5. Press the [S] key to save the threshold.  
The buzzer beeps and the value is displayed for a while.

Repeat the steps 3-0 to 3-5 above until all the thresholds are registered.

When all the thresholds are registered, the balance reverts to the measuring mode.



### 6.8.3 Indication of Judgment Result

(1) When <23 Pi.> (number of the threshold) is set to “1”.

Judgement result is indicated in the pointer form as shown below:

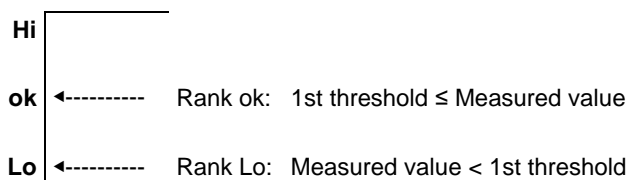

(2) When <23 Pi.> (number of the threshold) is set to “2”.

Judgement result can be indicated in the pointer form or in the bar-graph form.

Select setting value of “1” (pointer form) or “2” (bar graph form) for <2A. LG.> (How to indicate the result).

- Pointer form:

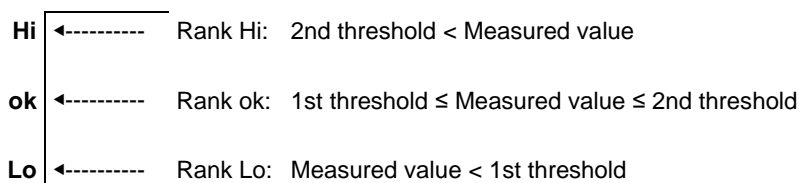

- Bar graph form:

	Rank Hi:	2nd threshold < Measured value
	Rank ok:	1st threshold ≤ Measured value ≤ 2nd threshold The ratio of the measured value to the two threshold values is displayed.
	Rank Lo:	Measured value < 1st threshold

**Reference**

Except for the specific gravity mode, all other functions, i.e., weighing mode, counting mode, percentage mode, and multiplied by coefficient mode can support this function.

(3) When <23 Pi.> (number of the threshold) is set to “3” or “4”.

Judgement result is indicated in the pointer form as shown below:

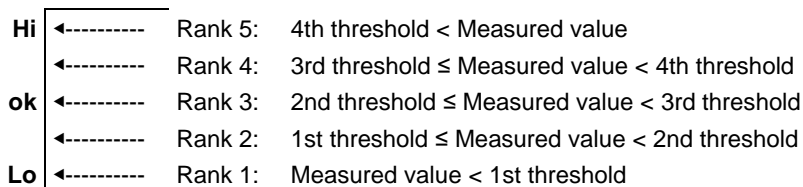

## 7 Settings According to the Measurement Environment

---

When the balance is stable, a circle is displayed. When it gets unstable, the sign goes out.

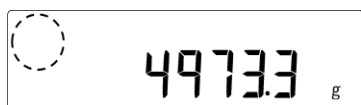

Unstable

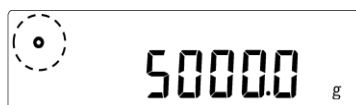

Stable

When the balance is affected by wind or vibration, numeric values on the display may flicker or the sign to indicate that the balance is stable may go out. In that case, improve the stability by function setting according to the following table.

Influence of wind or vibration	Items of basic function setting mode		
	Stability Judgment <4. S.d.>	Response Speed <5. rE.>	Readability <b2. d.A> or <b4. d.b>
Small ↑ ↓ Large	4 Strict 3 2 1 Mild	0 Sensitive mode 1 Fast 2 3 4 5 Slow	1 Fine 2 3 4 5 Rough

## 8 Miscellaneous Functions and Settings

### 8.1 Power settings

#### 8.1.1 Auto Sleep Function

This is a function to turn off the display when the balance is left to stand in measuring mode for about 3 minutes. To enable the auto sleep function, set <A. A.S.> to "1".

When the balance goes to the sleep mode, the Sleep lamp (LED) lights up.

To exit the sleep mode, touch the weighing pan or press a key.

(1) The auto sleep function does not work under the following conditions:

Reference

- At function setting mode.
- The display is not stable.

(2) Output is still possible during sleep mode.

#### 8.1.2 Direct Start Function

This is a function to turn on the balance automatically when it is connected to the power.

This function is useful when the balance is used in conjunction with other devices. To enable this function, set <L. d.St.> to "1".

### 8.2 Date and Time Indication and Setup

1 Display the time.



Press the [F] key for a few seconds.

When the display is changed from <Func> to <d-Set>, release the key.

To set the time, press the [F] key once.

The display shifts to the time (24-hour basis) indication after <TIME> indication.

Press [Output] key to cancel the setting and go back to the measuring mode.

Pressing the [F] key again skips the time setting and shift to the date display after <dAtE> is displayed.

2 Set the time.

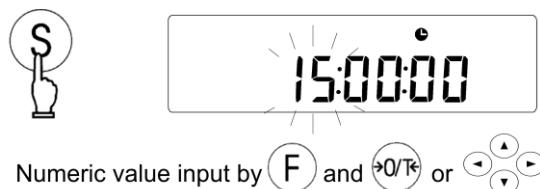

Press the [S] key during the time indication to launch the time setting mode.

Enter the time in "hh:mm:ss" format starting from a higher order digit with the following steps:



2-1. Select a number by pressing the [Zero/Tare] key, [▲] key, or [▼] key.

2-2. Press the [F] key, [▶] key or [◀] key to shift the digit to be entered.

2-3. Set the time by repeating steps 2-1 and 2-2.

Reference

Press the [Output] key to cancel the setup and goes back to the time indication.

<p>3 Save the time and display the date.</p> 	<p>Press the [S] key to save the settings. The changes are saved, and the display shifts to the date indication after &lt;dAtE&gt; indication. Pressing the [F] key again skips the date setting and the balance to go back to the measuring mode.</p>
<p>4 Set the date.</p>  <p>Numeric value input by <b>[F]</b> and <b>[0/T]</b> or <b>[←]</b>, <b>[↑]</b>, <b>[↓]</b>, <b>[→]</b></p>	<p>Press the [S] key during the date display to launch the date setting mode. Enter the date in the format selected in &lt;F. dAtE&gt;, starting from a higher order digit with the following steps:</p> <ol style="list-style-type: none"> <li>4-1. Select a number by pressing the [Zero/Tare] key, [▲] key, or [▼] key.</li> <li>4-2. Press the [F] key, [▶] key or [◀] key to shift the digit to be entered.</li> <li>4-3. Set the date by repeating steps 4-1 and 4-2.</li> </ol> <hr/> <p><b>Reference</b></p> <ol style="list-style-type: none"> <li>(1) Press the [Output] key to cancel the setup.</li> <li>(2) The date format can be selected by &lt;F. dAtE&gt; from the following: <ul style="list-style-type: none"> <li>"1": yy-mm-dd</li> <li>"2": mm-dd-yy</li> <li>"3": dd-mm-yy</li> </ul> ("yy" is the last two digit of the year.)</li> </ol> <hr/>
<p>5 Save the date.</p> 	<p>Press the [S] key to save the settings. The changes are saved, and the balance goes back to the measuring mode.</p>

**Reference**

Pressing the [Zero/Tare] key during the time indication rounds off the seconds and the time is rounded to the nearest minute.





### 8.3 ID No. Indication and Setup

An ID number is used when data is output in ISO/GLP/GMP format. Set an ID number when you print data.

When an ID number is displayed, two triangles, <◀> and <▲> are displayed in the upper left part of the display.

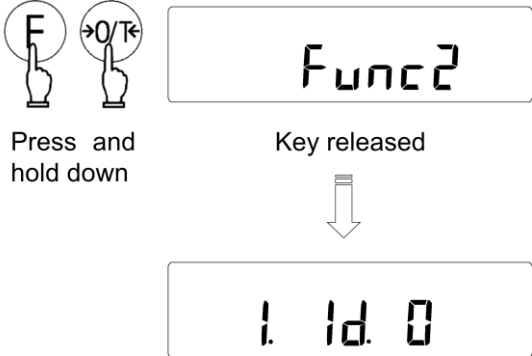
You can use up to 6 digits in an ID number. You can use “0-9”, “A-F”, and “-”, which are displayed in this order. An underscore “\_” indicates a blank space.

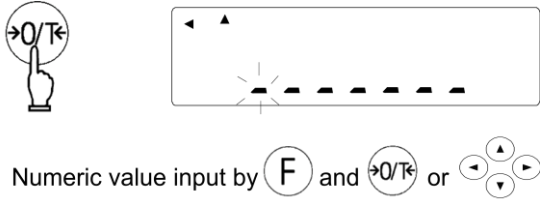
#### ID Number setting procedures

<p>1 Launch the advanced function setting mode.</p>  <p>Press and hold down</p> <p>Key released</p>	<p>Press the [F] key while holding down the [Zero/Tare] key.</p> <p>When &lt;Func2&gt; is displayed, release the key. The function setting item &lt;1. Id&gt; is displayed.</p>
<p>2 Select ID number indication and setup</p> 	<p>Press the [Zero/Tare] key to select “1”.</p>
<p>3 Display an ID number.</p> 	<p>Press the [S] key. The currently set ID number is displayed.</p> <p>If you want to skip the ID number setup, press the [Output] key, then the balance reverts to the measuring mode.</p>
<p>4 Enter an ID number.</p>  <p>Numeric value input by F and Zero/Tare or [F], [Right], [Left]</p>	<p>Press the [Zero/Tare] key to launch the ID number setting mode. Enter the ID number starting from a higher order digit with the following steps:</p> <ol style="list-style-type: none"> <li>4-1. Select a number by pressing the [Zero/Tare] key, [▲] key, or [▼] key.</li> <li>4-2. P Press the [F] key, [▶] key or [◀] key to shift the digit to be entered.</li> <li>4-3. Set the ID number by repeating steps 4-1 and 4-2.</li> </ol> <p>Pressing the [Output] key cancels the setting and fo back to the original ID number indication.</p>
<p>5 Save the ID number.</p> 	<p>Press the [S] key to save the settings. The changes are saved, and the balance goes back to the measuring mode.</p>

## 8.4 Power-on Tare Recall Function

When this function is activated, the last tare weight at the time the scale is powered off is recalled to tare-subtract when turning on the balance.

Use that function when you would like to prevent redoing the weighing operation due to an unexpected power failure in a place where the power supply is unstable.

To enable this function, set <J. tArE> to "1".

Note

Leaving the balance loaded for a long period may result in a larger error in weighing.

## 9 Input/Output Functions

### 9.1 D-SUP9P Connector for RS232C I/O

#### 9.1.1 Connector pin numbers and functions

Pin No.	Signal Name	Input/Output	Function & Remarks
1	-	-	-
2	RXD	Input	Receiving data
3	TXD	Output	Transmitting data
4	DTR	Output	This signal is fixed to "HIGH" while the balance is powered on.
5	GND	-	Signal ground
6	-	-	-
7	-	-	-
8	-	-	-
9	-	-	-

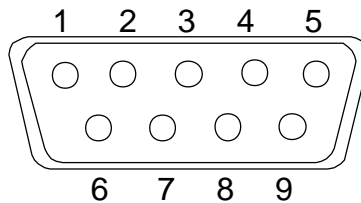

D-SUB9P Male Connector: Rear Panel

**Note**

Take care not to short-circuit the pin 4 (DTR) to the ground.

## 9.1.2 Connecting between Balance and Peripheral

Note

- (1) Be sure to disconnect the AC adapter from the power outlet before plugging or unplugging the connector.
- (2) Use shielded crossover serial cable up to 15 m length.

### ■■■ Sample connection with D-SUB9P ■■■

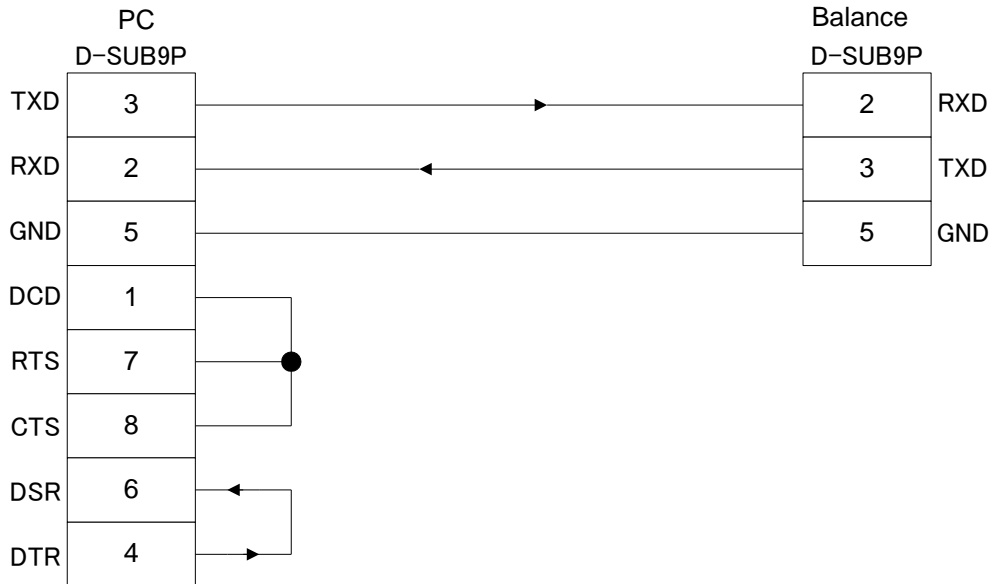

### ■■■ Sample connection with D-SUB25P ■■■

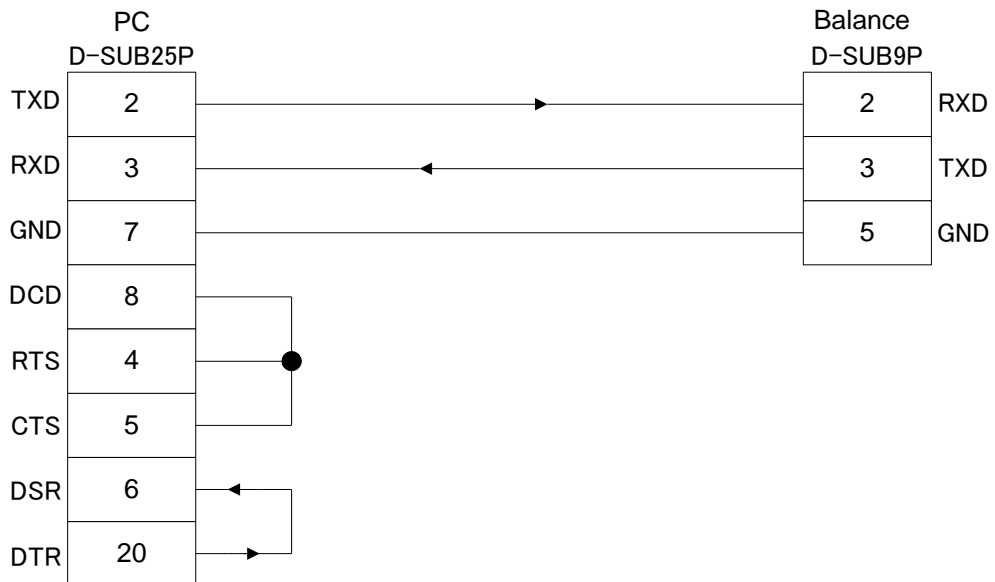



### 9.1.3 Interface specifications

- |                         |  |
|-------------------------|--|
| (1) Transmission system | Serial transmission, Start-stop synchronisation  |
| (2) Transmission rate   | 1200/2400/4800/9600/19200 bps  |
| (3) Transmission codes  | ASCII codes (8/7 bits)   |
| (4) Signal level        | Compliant with EIA RS-232C.<br>HIGH level (data logic 0) +5 to +15 V<br>Low level (data logic 1) -5 to -15 V   |
| (5) Bit configuration   | Start bit           1 bit<br>Data bits         8/7 bits<br>("7 bit" is not available for 6-digit numeric format and 7-digit numeric format.)<br>Parity bit        0/1 bit<br>(Parity bit is not available for 6-digit numeric format.)<br>Stop bits         2/1 bit<br>("1 bit" is not available for 6-digit numeric format and 7-digit numeric format.) |
| (6) Parity bit          | None/Odd/Even  |

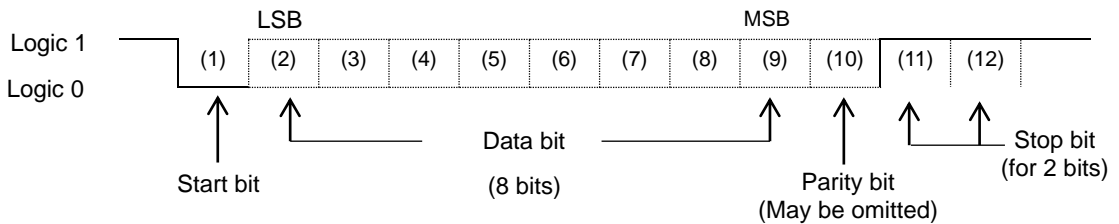

## 9.2 DIN 8-pin Connector for Serial Output for Peripherals

This connector provides a duplicate of the output from the D-SUB9P connector is output.

This connector also features a terminal for an external contact input that can perform tare subtraction or zero-point adjustment.

### 9.2.1 Connector pin numbers and functions

Pin No.	Signal Name	Input/Output	Function & Remarks
1	EXT.TARE	Input	External tare-subtraction/zero-point-adjustment *
2	-	-	-
3	-	-	-
4	TXD	Output	Transmitting data
5	GND	-	Signal ground
6	-	-	-
7	-	-	-
8	-	-	-

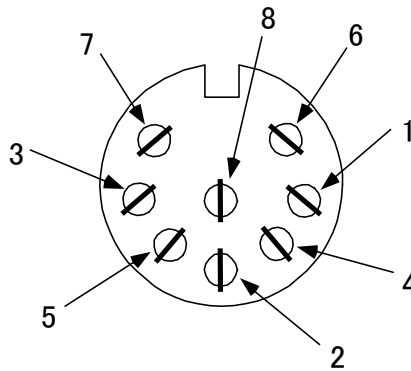

8-pin DIN IEC 60574-18 female connector  
for output to peripheral device

#### Note

- (1) Be sure to disconnect the AC adapter from the power outlet before plugging or unplugging the connector.
- (2) Use shielded cable up to 15 m length.

#### Reference

\* You can execute tare subtraction or zero-point adjustment from an external device by connecting a contact or a transistor switch between the pin 1 and pin 5.

In this case, allow at least 400 ms for connection (ON) time.

Open circuit voltage: 15 V

Sink current: 20 mA

## 9.2.2 Interface specifications

- |     |                     |   |
|-----|---------------------|---|
| (1) | Transmission system | Serial transmission, Start-stop synchronisation<br>Unidirectional from the balance to peripherals   |
| (2) | Transmission rate   | 1200/2400/4800/9600/19200 bps   |
| (3) | Transmission codes  | ASCII codes (8/7 bits)  |
| (4) | Signal level        | Compliant with EIA RS-232C.<br>HIGH level (data logic 0) +5 to +15 V<br>Low level (data logic 1) -5 to -15 V  |
| (5) | Bit configuration   | Start bit            1 bit<br>Data bits           8/7 bits<br>("7 bit" is not available for 6-digit numeric format and 7-digit numeric format.)<br>Parity bit          0/1 bit<br>(Parity bit is not available for 6-digit numeric format.)<br>Stop bits           2/1 bit<br>("1 bit" is not available for 6-digit numeric format and 7-digit numeric format.) |
| (6) | Parity bit          | None/Odd/Even   |

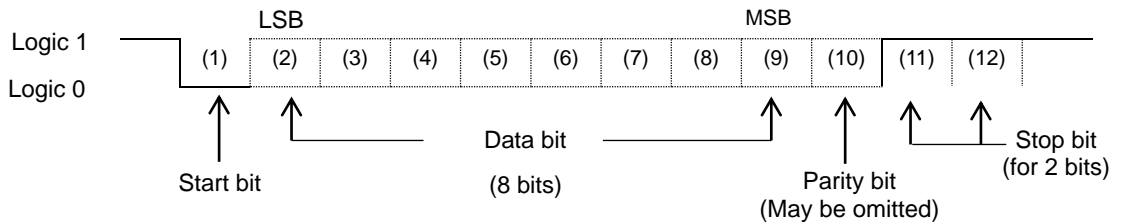

## 9.3 Output Data

There are following 6 output formats available: “6-digit numeric format”, “7-digit numeric format”, “extended 7-digit numeric format”, “special format 1”, “special format 2”, and “CBM format”.

Select a format in basic function setting mode by referring “5.1.2 Description of Basic Functions”.

### 9.3.1 Bit configuration for each format

Format	Start bit	Data bit	Parity bit	Stop bit
6-digit numeric format	1	8	0	2
7-digit numeric format	1	8	0 or 1	2
Extended 7-digit numeric format/ Special format 1/ Special format 2/ CBM format when <E3. P.F.> is set to “1”	1	7 or 8	0 or 1	1 or 2
Extended 7-digit numeric format/ Special format 1/ Special format 2/ CBM format when <E3. P.F.> is set to “2”	1	8	0 or 1	1 or 2

### 9.3.2 6/7-digit numeric format and extended 7-digit numeric format

#### 9.3.2.1 Data composition

##### ■6-digit numeric format

Composed of 14 characters including terminators (CR=0DH, LF=0AH).

1	2	3	4	5	6	7	8	9	10	11	12	13	14
P1	D1	D2	D3	D4	D5	D6	D7	U1	U2	S1	S2	CR	LF

##### ■7-digit numeric format and extended 7-digit numeric format

Composed of 15 characters including terminators (CR=0DH, LF=0AH).

1	2	3	4	5	6	7	8	9	10	11	12	13	14	15
P1	D1	D2	D3	D4	D5	D6	D7	D8	U1	U2	S1	S2	CR	LF

#### (1) Polarity (P1: 1 character)

P1	Code	Description
+	2BH	When data is 0 or positive.
-	2DH	When data is negative.

**(2) Numeric data (D1 to D7/D8: seven or eight characters)**

Format	Length
6-digit numeric format	7 characters, from D1 to D7
7-digit numeric format and extended 7-digit numeric format	8 characters, from D1 to D8

D1 to D7/D8	Code	Description
0 – 9	30H to 39H	Digits 0 – 9 0 is also used to fill the leading portion of value (leading zero padding)
•	2EH	Decimal point (floating position) *When the data is an integer, it may be omitted and replaced with a blank space in the lowest-order place.
Space	20H	Space: Used to fill the leading portion of value (leading zero suppress)

**Reference**

The choice between leading zero padding and leading zero suppress can be switched by <66. n.u.>.

**(3) Units (U1, U2: 2 characters)**

U1	U2	Code		Meaning	Balance indicators
Space	G	20H	47H	gram	g
K	G	4BH	47H	kilogram	kg
C	T	43H	54H	carat	ct
O	Z	4FH	5AH	ounce	oz
L	B	4CH	42H	pound	lb
O	T	4FH	54H	troy ounce	oz t
D	W	44H	57H	pennyweight	dwt
G	R	4BH	52H	grain	GN
T	L	54H	4CH	tael troy (Hong Kong)	tl
T	L	54H	4CH	tahil (Singapore, Malaysia)	tl and ▶ of upper right
T	L	54H	4CH	tael (Taiwan)	tl and ▶ of middle right
M	O	4DH	4FH	momme	mom
t	o	74H	6FH	tola (India)	to
P	C	50H	43H	Counting mode	Pcs
Space	%	20H	25H	Percentage mode	%
Space	#	20H	23H	Multiplied by coefficient mode	#

**(4) Type of the data or judgment result of the comparator function (S1: 1 character)**

S1	Code	Description	
L	4CH	Rank Lo	When the comparator function is enabled and the number of thresholds is 1 or 2.
G	47H	Rank ok	
H	48H	Rank Hi	
1	31H	Rank 1	When the comparator function is enabled and the number of thresholds is 3 or 4.
2	32H	Rank 2	
3	33H	Rank 3	
4	34H	Rank 4	
5	35H	Rank 5	
T	54H	Total value	When the addition function is activated and output is performed at total value indication.
U	55H	Unit weight	When the counting mode is activated and output is performed at unit weight indication.
d	64H	Gross	When the weighing mode is activated and output is performed at gross weight indication.
Space	20H	No judgment result or no data type specified	

**(5) Status (S2:1 character)**

S2	Code	Description	
S	53H	Data stable	These values may be appended even when the data is not related to stability or instability (e.g., total value or unit weight), in which case these are meaningless.
U	55H	Data unstable	
E	45H	Data error (Indicates that data other than S2 is invalid.) (<o-Err>, <u-Err>)	
Space	20H	No status specified	

### 9.3.3 Special format 1

#### 9.3.3.1 Data composition

1	2	3	4	5	6	7	8	9	10	11	12	13	14	15	16
P1	Space (20H)	D1	D2	D3	D4	D5	D6	D7	D8	Space (20H)	U1	U2	U3	CR (0DH)	LF (0AH)
Polarity	Space	Measurement data (including decimal point)								Space	Unit			Terminator	

#### (1) Polarity (P1: 1 character)

P1	Code	Description
+	2BH	When data is 0 or positive.
-	2DH	When data is negative.

#### (2) Numeric data (D1-D8: 8 characters, right aligned)

D1 to D8	Code	Description
0 – 9	30H to 39H	Digits 0 – 9
•	2EH	Decimal point (floating position)
Space	20H	Space: Used to fill the leading portion of value (leading zero suppress)

**Reference**

- The leading portion of the value is filled with space (20H) regardless of the function settings of <66. n.u.>.

#### (3) Unit (U1-U3: 3 characters)

U1	U2	U3	Code			Meaning	Balance indication
g	Space	Space	67H	20H	20H	gram	<b>g</b>
k	g	Space	6BH	67H	20H	kilogram	<b>kg</b>
c	t	Space	63H	74H	20H	carat	<b>ct</b>
o	z	Space	6FH	7AH	20H	ounce	<b>oz</b>
l	b	Space	6CH	62H	20H	pound	<b>lb</b>
o	z	t	6FH	7AH	74H	troy ounce	<b>oz t</b>
d	w	t	64H	77H	74H	pennyweight	<b>dwt</b>
G	N	Space	47H	4EH	20H	grain	<b>GN</b>
t	l	h	74H	6CH	68H	tael troy (Hong Kong)	<b>tl</b>
t	l	s	74H	6CH	73H	Tahil (Singapore, Malaysia)	<b>tl</b> and ► of upper right
t	l	t	74H	6CH	74H	tael (Taiwan)	<b>tl</b> and ► of middle right
m	o	m	6DH	6FH	6DH	momme	<b>mom</b>
t	o	l	74H	6FH	6CH	tola (India)	<b>to</b>
p	c	s	70H	63H	73H	Counting mode	<b>Pcs</b>
%	Space	Space	25H	20H	20H	Percentage mode	<b>%</b>
#	Space	Space	23H	20H	20H	Multiplied by coefficient mode	<b>#</b>
Space	Space	Space	20H	20H	20H	Data unstable	< o > is not indicated.

### 9.3.3.2 Error output

<o-Err>:

1	2	3	4	5	6	7	8	9	10	11	12	13	14	15	16
Space (20H)	Space (20H)	Space (20H)	Space (20H)	Space (20H)	Space (20H)	H (48H)	Space (20H)	Space (20H)	Space (20H)	Space (20H)	Space (20H)	Space (20H)	Space (20H)	CR (0DH)	LF (0AH)

<u-Err>:

1	2	3	4	5	6	7	8	9	10	11	12	13	14	15	16
Space (20H)	Space (20H)	Space (20H)	Space (20H)	Space (20H)	Space (20H)	L (4CH)	Space (20H)	Space (20H)	Space (20H)	Space (20H)	Space (20H)	Space (20H)	Space (20H)	CR (0DH)	LF (0AH)

### 9.3.4 Special format 2

#### 9.3.4.1 Data composition

1	2	3	4	5	6	7	8	9	10	11	12	13	14	15	16	17	18	19	20
S1	S2	S3	Space (20H)	D1	D2	D3	D4	D5	D6	D7	D8	D9	D10	Space (20H)	U1	U2	U3	CR (0DH)	LF (0AH)
Status			Space	Measurement data (including polarity and decimal point)										Space	Unit (One to three characters)			Terminator	

#### (1) Status (S1-S3: 3 characters)

S1	S2	S3	Code			Meaning
S	Space	S	53H	20H	53H	Data stable
S	Space	D	53H	20H	44H	Data unstable

#### (2) Numeric data (D1-D10: 10 characters, right aligned)

D1 to D10	Code	Description
-	2DH	When data is negative.
0 – 9	30H to 39H	Digits 0 – 9
•	2EH	Decimal point (floating position)
Space	20H	Space: Used to fill the leading portion of value (leading zero suppress)

**Reference**

- The leading portion of the value is filled with space (20H) regardless of the function settings of <66. n.u.>.



**(3) Unit (U1-U3: 1 to 3 character(s), variable length)**

U1	U2	U3	Code			Meaning	Balance indication
g	/	/	67H	/	/	gram	<b>g</b>
k	g	/	6BH	67H	/	kilogram	<b>kg</b>
c	t	/	63H	74H	/	carat	<b>ct</b>
o	z	/	6FH	7AH	/	ounce	<b>oz</b>
l	b	/	6CH	62H	/	pound	<b>lb</b>
o	z	t	6FH	7AH	74H	troy ounce	<b>oz t</b>
d	w	t	64H	77H	74H	pennyweight	<b>dwt</b>
g	r	/	67H	72H	/	grain	GN
t	l	h	74H	6CH	68H	tael troy (Hong Kong)	<b>tl</b>
t	l	s	74H	6CH	73H	Tahil (Singapore, Malaysia)	<b>tl</b> and ► of upper right
t	l	t	74H	6CH	74H	tael (Taiwan)	<b>tl</b> and ► of middle right
m	o	m	6DH	6FH	6DH	momme	mom
t	l	a	74H	6CH	61H	tola (India)	<b>to</b>
p	c	s	70H	63H	73H	Counting mode	Pcs
%	/	/	25H	/	/	Percentage mode	%
#	/	/	23H	/	/	Multiplied by coefficient mode	#

**9.3.4.2 Error output**

<o-Err>:

1	2	3	4	5
S (53H)	Space (20H)	+	CR (0DH)	LF (0AH)

<u-Err>:

1	2	3	4	5
S (53H)	Space (20H)	-	CR (0DH)	LF (0AH)

### 9.3.5 CBM format

#### 9.3.5.1 Data composition

Composed of 26 characters including terminators (CR=0DH/LF=0AH)

1	2	3	4	5	6	7	8	9	10	11	12	13
S1	C1	Space (20H)	T1	T2	T3	T4	T5	T6	D1	D2	D3	D4
14	15	16	17	18	19	20	21	22	23	24	25	26
D5	D6	D7	D8	D9	D10	D11	D12	U1	U2	Space (20H)	CR (0DH)	LF (0AH)

#### ERROR

1	2	3	4	5	6	7	8	9	10	11	12	13
*	*	Space (20H)	E	R	R	O	R	Space (20H)	*	*	*	*
(2AH)	(2AH)	(20H)	(2AH)	(2AH)	(2AH)	(2AH)	(2AH)	(20H)	(2AH)	(2AH)	(2AH)	(2AH)
14	15	16	17	18	19	20	21	22	23	24	25	26
*	*	*	*	*	*	*	*	*	*	Space (20H)	CR (0DH)	LF (0AH)
(2AH)	(2AH)	(2AH)	(2AH)	(2AH)	(2AH)	(2AH)	(2AH)	(2AH)	(2AH)	(20H)	(0DH)	(0AH)

#### Meaning of the data

Symbol	Code	Description	
"S1" (1 character) Represents the status.			
SPACE	20H	Data stable	
*	2AH	Data unstable	
"C1" (1 character) Represents the result of comparator function.			
SPACE	20H	Rank ok or No result	When the comparator function is enabled and the number of thresholds is 1 or 2.
H	48H	Rank Hi	
L	4CH	Rank Lo	
1	31H	Rank 1	When the comparator function is enabled and the number of thresholds is 3 or 4.
2	32H	Rank 2	
3	33H	Rank 3	
4	34H	Rank 4	
5	35H	Rank 5	

Symbol						Code						Description		
"T1"- "T6" (6 characters) Represents the type of the data.														
Space	Space	Space	Space	Space	Space	20H	20H	20H	20H	20H	20H	Net weight		
T	O	T	A	L	Space	54H	4FH	54H	41H	4CH	20H	Total value (Addition function)		
G	Space	Space	Space	Space	Space	47H	20H	20H	20H	20H	20H	Gross weight		
U	N	I	T	Space	Space	55H	4EH	49H	5H4	20H	20H	Unit weight		
"D1"- "D12" (12 characters) Numeric value data is stored.														
+						2BH						When the data are 0 or positive		
-						2DH						When the data are negative		
0 – 9						30H –39H						Numeric value (0 – 9) 0 is also used to fill the leading portion of value (leading zero padding)		
.						2EH						Decimal point (floating decimal point)		
Space						20H						- Spaces fill the top of the data. - Output to the least significant digit in the absence of a decimal point - Used to fill the leading portion of value (leading zero suppress)		
"U1", "U2" (2 characters) Represents the unit of numeric value data.														
Space		g		20H		67H		gram		g				
k		g		6BH		67H		kilogram		kg				
c		t		63H		74H		carat		ct				
o		z		6FH		7AH		ounce		oz				
l		b		6CH		62H		pound		lb				
O		T		4FH		54H		troy ounce		oz t				
d		w		64H		77H		pennyweight		dwt				
G		R		47H		52H		grain		GN				
t		l		74H		6CH		tael troy (Hong Kong)		tl				
t		l		74H		6CH		tahil (Singapore, Malaysia)		tl and ▶ of upper right				
t		l		74H		6CH		Tael (Taiwan)		tl and ▶ of middle right				
m		o		6DH		6FH		momme		mom				
t		o		74H		6FH		tola (India)		to				
P		C		50H		43H		Counting mode		Pcs				
Space		%		20H		25H		Percentage mode		%				
Space		#		20H		23H		Multiplied by coefficient mode		#				

### 9.3.6 Interval Output Function

This is a function to output data at regular intervals.



**Reference**

- (1) Interval output function is enabled in weighing mode, counting mode, and percentage mode. It is not enabled at other modes including function setting mode.
- (2) <6-Err> is displayed when interval time is set to zero.

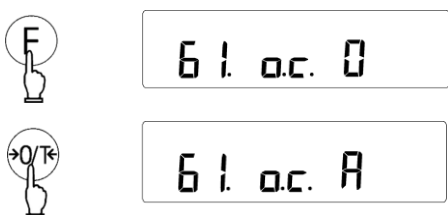
#### 9.3.6.1 Set interval output

<p>1 Launch the basic function setting mode.</p>  <p>Press and hold down</p> <p>Key released</p>	<p>Press and hold down the [F] key. After &lt;Func&gt; is displayed, release the key. The function setting item &lt;1. SEt.&gt; is displayed.</p>
<p>2 Select "Interval output".</p> 	<p>Press the [F] key several times to go to &lt;61. o.c.&gt;. Then press the [Zero/Tare] key several times to select "A" or "b". "A": Output at every pre-set time interval. "b": Output at every pre-set time interval when the balance is stable (Stop output when the balance is unstable).</p>

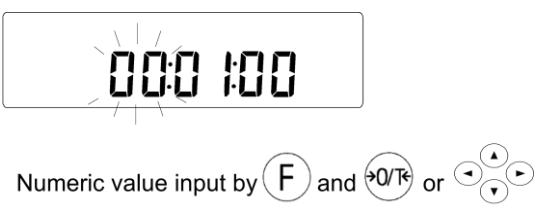
#### 9.3.6.2 Set interval time

<p>1 Call the interval function.</p>  <p>Press and hold down</p>	<p>Press and hold down the [S] key until the display indicates &lt;Int.VAL&gt;. Interval time setting mode is launched and the display indicates an interval with the leftmost digit blinking.</p>
<p>2 Set an interval.</p>  <p>Numeric value input by [F] and [Zero/Tare] or [Up/Down] keys</p>	<p>Enter the interval time in "hh:mm:ss" format starting from a higher order digit with the following steps: 2-1. Select a number by pressing the [Zero/Tare] key, [▲] key, or [▼] key. 2-2. Press the [F] key, [▶] key or [◀] key to shift the digit to be entered. 2-3. Set the time by repeating steps 2-1 and 2-2.</p> <p><b>Reference</b></p> <p>Pressing the [Output] key cancels the input and returns to the &lt;Int.VAL&gt; indication. Press the [Set] key to start the interval time input again.</p>
<p>3 Save the settings, and go back to measuring mode.</p> 	<p>Press the [S] key to save the setting and return to the measuring mode.</p>

### 9.3.6.3 Start interval output

Press the [Output] key. The display indicates <StArt>, and starts interval output. <G> blinks during interval output. <F> lights up when data is output.

### 9.3.6.4 Stop interval output

Press the [Output] key again. The display indicates <End> and interval output stops.

### 9.3.6.5 Data format

When each interval output is started or stopped, a header and a footer are output.

#### Header

15 characters of "-" (2DH) is output with DC2 (12H) in front and CR (0DH), LF (0AH) and DC4 (14H) behind.

1	2	3	4	5	6	7	8	9	10	11	12	13	14	15	16	17	18	19
DC2	-	-	-	-	-	-	-	-	-	-	-	-	-	-	-	CR	LF	DC4

#### Footer

Two linefeeds are inserted.

### 9.3.7 Time Stamp Output

When the time stamp output function <G. t.o.> is set to "1" (enabled), the time is output before the measurement data, with DC2 (12H) in front and CR (0DH), LF (0AH) and DC4 (14H) behind.

1	2	3	4	5	6	7	8	9	10	11	12
DC2	h	h	:	m	m	:	s	s	CR	LF	DC4

\* hh: hour (00-23), mm: minute (00-59), ss: second (00-59)

## 9.4 Input Commands

---

**Reference**

Input commands can only be entered through D-SUP9P connector for RS232C I/O.

---

The following 7 types of input commands are supported:

- |  |                                 |
|--|---------------------------------|
| (1) Tare-subtraction/zero-point adjustment command | (2) Set output control command  |
| (3) Set measuring mode command                     | (4) Request date output command |
| (5) Request time output command                    | (6) Set interval command        |
| (7) Span adjustment/test command                   |                                 |

### 9.4.1 Procedure for transmission

- (1) A command is transmitted to the balance from an external device. Since the data flow (transmission and reception) is stored by a full-duplex system, commands can be transmitted regardless of their data-transmission timing.
- (2) When the balance has executed the received command, it activates a normal end response or transmits the requested data, via the transmitting command. If the balance was unable to execute the command or received an erroneous command, it transmits an error end response. If the balance is working properly, it usually returns a response within a second after it receives the transmitted command. If the balance receives a transmission while it is conducting a procedure (such as the setup of a function or a span adjustment), it will transmit a response when the procedure finishes.
- (3) When transmitting more than one command to the balance from a remote device, wait until you have received a confirmation on the first transmission before transmitting the next.

## 9.4.2 Response

You can select the response format of either the A00/Exx format or the ACK/NAK format by <67. r.ES.> of basic function setting mode.

### (1) A00/Exx format

Consists of 5 characters including terminators (CR=0DH, LF=0AH).

1      2      3      4      5

A1	A2	A3	CR	LF
----	----	----	----	----

Response command

A1	A2	A3	Code			Meaning
A	0	0	41H	30H	30H	Successful completion
E	0 - 9	0- 9	45H	30H   39H	30H   39H	Various errors such as: - Command error (an errant command is received) - Numeric format error - Processing interrupted - Processing terminated abnormally - Other errors

### (2) ACK/NAK format

Consists of 1 character (Does not contain a terminator).

1

A1
----

Response command

A1	Code	Meaning
ACK	06H	Successful completion
NAK	15H	Various errors such as: - Command error (an errant command is received) - Numeric format error - Processing interrupted - Processing terminated abnormally - Other errors

### 9.4.3 Input Command Format 1

Composed of four characters including a terminator (CR=0DH/LF=0AH).

1	2	3	4
C1	C2	CR	LF

#### (1) Tare-subtraction/zero-point-adjustment command

C1	C2	Code		Description	Response	
					A00/Exx	ACK/NAK
T	Space	54H	20H	Tare-subtraction/ zero-point-adjustment	A00: Successful completion E01: Command error E04: Tare-subtraction /zero-point-adjustment execution error due to a range violation or unstable loads	ACK: Successful completion NAK: Error

#### (2) Set output control command

C1	C2	Code		Description	Response	
					A00/Exx	ACK/NAK
O	0	4FH	30H	Stop output	A00: Successful completion E01: Command error	ACK: Successful completion NAK: Error
O	1	4FH	31H	Output continuously at all times		
O	2	4FH	32H	Output continuously if stable (Stop output if unstable)		
O	3	4FH	33H	Output once by pressing [Output] key (Irrespective of whether the balance is stable or not).		
O	4	4FH	34H	Output once when the balance is loaded and stabilised. The next output for another sample loading is executed once the indication becomes stabilised at less than or equal to zero by unloading and zero-point adjustment.		
O	5	4FH	35H	Output once every time when the balance reaches stable (Stop output at unstable times).		
O	6	4FH	36H	Output continuously at unstable times and output once every time when the balance reaches stable.		
O	7	4FH	37H	Output once after [Output] key is pressed and the balance reaches stable.		
O	8	4FH	38H	Output once immediately.		
O	9	4FH	39H	Output once after stabilised.		
O	A	4FH	41H	Output at every pre-set time interval.	A00: Successful completion E01: Command error E02: Interval time setting error	ACK: Successful completion NAK: Error
O	B	4FH	42H	Output at every pre-set time interval when the balance is stable (Stop output when the balance is unstable).		

- (1) The output controls executed with commands "O0" to "O7" work the same as the settings in <61. o.c.>.
- (2) The commands "O8" and "O9" are data request commands issued to the balance. After the "O8" or "O9" command has executed and balance has performed an output, the balance stops outputting until the next output command comes along.
- (3) Once any command from "O0" to "O7" is executed, the balance runs that function until another command is entered. However, if the balance is switched off and on again, the output control is reset to the initial function setting.
- (4) When command "OA" or "OB" is input, interval output is initiated, and when the same command is input again, interval output is terminated.

Reference



### (3) Set display command

C1	C2	Code		Description	Response	
					A00/Exx	ACK/NAK
M	1	4DH	31H	Set to Display 1	A00: Successful completion E01: Command error E02: Error	ACK: Successful completion NAK: Error
M	2	4DH	32H	Set to Display 2		
M	3	4DH	33H	Set to Display 3		
M	4	4DH	34H	Set to Display 4		

**Reference**

The display to be activated by the above commands "M1" to "M4" depends on the measuring mode currently in use.

Mode Display	Weighing mode	Counting mode	Percentage mode	Multiplied by coefficient mode	Specific gravity mode / Statistics mode
Display 1	Net weight in unit A	Net weight in unit A	Net weight in unit A	Net weight in unit A	(Error)
Display 2	Gross weight in unit A	Counting	Percentage	Multiplied value	(Error)
Display 3	Total of weight *1	Total of counting *1	Total of percentage *1	Total of multiplied value *1	(Error)
Display 4	Net weight in unit B *2	Unit weight	(Error)	(Error)	(Error)

**Reference**

\*1 Display 3 (M3) can be specified only when the addition function is enabled. If the addition function is not enabled, it results in an error.

\*2 If the unit B is NOT specified, the display is set to the net weight in unit A.

### (4) Date or time output request command

C1	C2	Code		Description	Response	
					A00/Exx	ACK/NAK
D	D	44H	44H	Date output	A00: Successful completion E01: Command error	ACK: Successful completion NAK: Error
D	T	44H	54H	Time output		

Date output and time output initiated by above commands are as follows:

Date output (Date format varies depending on the setting of <F. dA.tE>.):

DS2 (12H)	D (44H)	A (41H)	T (54H)	E (45H)	:	d	d	.	m	m	.	y	y	y	y	CR (0DH)	LF (0AH)	DS4 (14H)
--------------	------------	------------	------------	------------	---	---	---	---	---	---	---	---	---	---	---	-------------	-------------	--------------

Time output:

DS2 (12H)	T (54H)	I (49H)	M (4DH)	E (45H)	:	Space (20H)	Space (20H)	Space (20H)	Space (20H)	Space (20H)	h	h	:	m	m	CR (0DH)	LF (0AH)	DS4 (14H)
--------------	------------	------------	------------	------------	---	----------------	----------------	----------------	----------------	----------------	---	---	---	---	---	-------------	-------------	--------------

**(5) Span adjustment/test command**

C1	C2	Code		Description	Response	
					A00/Exx	ACK/NAK
C	0	43H	30H	Disable the calibration through the [Cal] key or command inputs.	A00: Successful completion E01: Command error E02: Operation is disabled E03: Cancelled E04: Abnormal completion	ACK: Successful completion NAK: Error
C	1	43H	31H	Launch span adjustment with internal calibration weight (semi-automatic span adjustment)		
C	2	43H	32H	Launch span test with internal calibration weight		
C	3	43H	33H	Launch span adjustment with external weight		
C	4	43H	34H	Launch span test with external weight		

**Reference**

- When <7. CA.> is set to "0" (Calibration disabled), the commands "C1" to "C4" do not work.
- When "C0" is once input, calibration is disabled until the balance is turned on again or <7. CA.> is set to other than "0" by keystroke.

## 9.4.4 Input Command Format 2

Composed of variable length of characters including a terminator (CR=0DH/LF=0AH).

C1	C2	,	D1	...	Dn	CR (0DH)	LF (0AH)
----	----	---	----	-----	----	-------------	-------------

### (1) Setting intervals

C1	C2	Code		Description	D1 ... D8	Response	
						A00/Exx	ACK/NAK
I	A	49H	41H	Interval time setup	Interval time "hh,mm,ss" (hh: hours, mm: minutes, ss: seconds, separated by commas.)	A00: Successful completion E01: Command error E02: Set value error	ACK: Successful completion NAK: Error

#### Command sample:

Set the interval time to 1 hours, 23 minutes and 45 seconds: IA,01,23,45(CR)(LF)

### (2) Setting thresholds for comparator function

C1	C2	Code		Description	D1 ... Dn	Response	
						A00/Exx	ACK/NAK
L	A	4CH	41H	1st threshold setup	Numeric value without unit	A00: Successful completion E01: Command error E02: Set value error	ACK: Successful completion NAK: Error
L	B	4CH	42H	2nd threshold setup			
L	C	4CH	43H	Reference value setup			
L	D	4CH	44H	3rd threshold setup			
L	E	4CH	45H	4th threshold setup			

**Reference**

Enter the value with respect to the current measuring mode.  
In weighing mode, the unit set in Unit A is applied to the entered value.

#### Command sample:

Set the 2nd threshold to 100.0 g: LB,100.0(CR)(LF)

## 10 Calibration of the balance

An electronic balance, which is influenced by the acceleration of gravity, indicates different values depending on the location it is used. For this reason, you should calibrate your balance every time you relocate it. You should also calibrate it after a long time of no use or when it does not indicate correct values.

- Span adjustment: To decrease the difference between an indicated value and the true value.
- Span test: To check true value minus the current weight (the inverse of the "instrumental error").

When "Advice CAL" is activated, the balance generates an alarm when calibration is needed.



Note

The calibration significantly affects the weighing accuracy. Please read the procedure carefully before performing this function.

### 10.1 Select the calibration mode

Reference

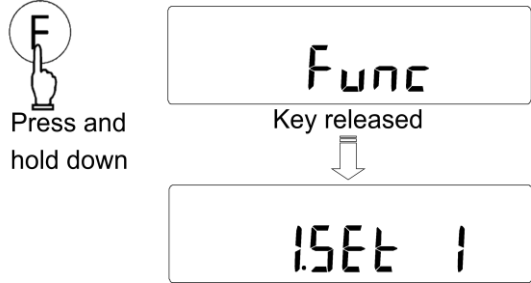
The item "1" (Span adjustment with internal calibration weight) and "2" (Span test with internal calibration weight) of <7. CA.> are available only on the models with internal calibration weight.

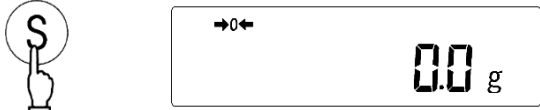

<p>1 Launch the basic function setting mode.</p>  <p>Press and hold down</p> <p>Key released</p>	<p>Press and hold down the [F] key. After &lt;Func&gt; is displayed, release the key. The function setting item &lt;1. SEt.&gt; is displayed.</p>
<p>2 Select the calibration mode evoked by the [Cal] key.</p> 	<p>Press the [F] key several times to go to &lt;7. CA.&gt;. Then press the [Zero/Tare] key to select:</p> <ul style="list-style-type: none"> <li>"0": Disable the calibration</li> <li>"1": Span adjustment with internal calibration weight (Semi-automatic span adjustment)</li> <li>"2": Span test with internal calibration weight</li> <li>"3": Span adjustment with external weight</li> <li>"4": Span test with external weight</li> </ul>
<p>3 Complete the setting of functions.</p> 	<p>Press the [S] key to return to the measuring mode.</p>

## 10.2 Span Adjustment with Internal Calibration Weight (Semi-Automatic Span Adjustment)

This function is only available on models LNA623R, LNA1202R, LNA2202R, LNA 3202R, and LNA4202R of the LNA series, which have the internal calibration mechanism.

<b>Note</b>	<p>To ensure that the span adjustment is carried out accurately, please note the following before starting this function:</p> <ul style="list-style-type: none"> <li>- Ensure that the balance installed properly levelled</li> <li>- Ensure that the equipment is not subject to environmental influences such as wind, vibration, temperature changes and changes in air pressure.</li> </ul>
-------------	---





<b>Reference</b>	<p>(1) Set &lt;7. CA.&gt; to "1" before performing this function.          (2) Pressing the [Output] key cancels the sequence midway.</p>
------------------	---

<p>1 Energise the balance for longer than 30 minutes and load the balance a few times with a weight equivalent to the maximum capacity.</p>	
<p>2 Check that no load is on the weighing pan.</p> 	
<p>3 Launch the span adjustment sequence.</p>  	<p>Press the [Cal] key.</p> <p>The span adjustment sequence is evoked and the display switches in the order &lt;Aut. CAL&gt;, &lt;WAlT&gt;, &lt;CH. 0&gt;, &lt;CH. F.S.&gt;, &lt;buSy&gt;, and &lt;End&gt;.</p> <p>When span adjustment is completed, the indication reverts to measuring mode.</p> <hr/> <p><b>Reference</b></p> <p>For models LNA2202R, LNA3202R and LNA4202R, progress of the sequence is displayed in bar graph.</p>

## 10.3 Span Adjustment with External Weight

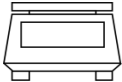
<div style="border: 1px solid black; border-radius: 10px; padding: 5px; display: inline-block;">Note</div>	<p>(1) The recommended external weight used for the span adjustment are those equivalent to:</p> <ul style="list-style-type: none"> <li>- OIML E2 for models LNA623, LNA623R, and LNA6202; and</li> <li>- OIML F1 for other models.</li> </ul> <p>(2) Use a weight for calibration that weighs 50% of the weighing capacity or heavier. To calibrate more accurately, use a weight that is close to the weighing capacity.</p> <p>(3) To ensure that the span adjustment is carried out accurately, please note the following before starting this function:</p> <ul style="list-style-type: none"> <li>- Ensure that the balance installed properly levelled</li> <li>- Ensure that the equipment is not subject to environmental influences such as wind, vibration, temperature changes and changes in air pressure.</li> </ul>
--	--

<div style="border: 1px solid black; border-radius: 10px; padding: 5px; display: inline-block;">Reference</div>	<p>(1) Set &lt;7. CA.&gt; to "3" before performing this function.</p> <p>(2) Pressing the [Output] key cancels the sequence midway.</p>
---	---



<p>1 Energise the balance for at least 5 minutes and load the balance a few times with a weight equivalent to the maximum capacity. Warm-up of more than 30 minutes is more recommended.</p>	
<p>2 Check that no load is on the weighing pan.</p> <div style="text-align: center; margin-top: 10px;">  </div>	
<p>3 Launch the span adjustment sequence.</p> <div style="display: flex; align-items: center; justify-content: center; margin-top: 10px;"> <div style="border: 1px solid gray; padding: 5px; margin-right: 20px;">  </div> <div style="text-align: center;">  </div> </div>	<p>Press the [Cal] key to launch the span adjustment sequence.</p>
<p>4 Zero-point calibration</p> <div style="display: flex; align-items: center; margin-top: 10px;"> <div style="text-align: center; margin-right: 20px;">  </div> <div style="border: 1px solid gray; padding: 5px; margin-left: 20px;"> <div style="text-align: right; font-size: small; margin-bottom: 5px;">CAL</div> <div style="font-size: 2em; font-weight: bold; margin: 0;">on 0.</div> </div> </div>	<p>The display first indicates &lt;CAL EXT&gt;, and then &lt;on 0&gt;, and the balance starts calibrating the zero point. (If the display indicates &lt;PuSH. F&gt;, press the [F] key).</p>
<p>5 Calibration of the capacity point, and span adjustment</p> <div style="display: flex; align-items: center; margin-top: 10px;"> <div style="text-align: center; margin-right: 20px;">  </div> <div style="border: 1px solid gray; padding: 5px; margin-left: 20px;"> <div style="text-align: right; font-size: small; margin-bottom: 5px;">CAL</div> <div style="font-size: 2em; font-weight: bold; margin: 0;">on F.S.</div> </div> </div>	<p>The display switches to &lt;on F.S.&gt;. Load a calibration weight on the weighing pan.  (If the display indicates &lt;PuSH. F&gt;, press the [F] key). The balance starts calibrating the weighing capacity point.</p>
<p>6 Completion of the span adjustment sequence</p>	<p>The display indicates &lt;buSy&gt; and &lt;End&gt; in sequence. When span adjustment is completed, the indication reverts to measuring mode.</p>

## 10.4 Span Test with Internal Calibration Weight

This function is only available on models LNA623R, LNA1202R, LNA2202R, LNA 3202R, and LNA4202R of the LNA series, which have the internal calibration mechanism.

<div style="border: 1px solid black; border-radius: 10px; padding: 2px 5px; display: inline-block;">Note</div>	<p>To ensure that the span test is carried out accurately, please note the following before starting this function:</p> <ul style="list-style-type: none"> <li>- Ensure that the balance installed properly levelled</li> <li>- Ensure that the equipment is not subject to environmental influences such as wind, vibration, temperature changes and changes in air pressure.</li> </ul>
--	---

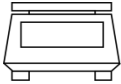



<div style="border: 1px solid black; border-radius: 10px; padding: 2px 5px; display: inline-block;">Reference</div>	<p>(1) Set &lt;7. CA.&gt; to "2" before performing this function.          (2) Pressing the [Output] key cancels the sequence midway.</p>
---	---

<p>1 Energise the balance for at least 5 minutes and load the balance a few times with a weight equivalent to the maximum capacity. Warm-up of more than 30 minutes is more recommended.</p>	
<p>2 Check that no load is on the weighing pan.</p> <div style="text-align: center; margin-top: 10px;">  </div>	
<p>3 Launch the span test sequence.</p> <div style="display: flex; align-items: center; margin-top: 10px;"> <div style="border: 1px solid black; padding: 5px; margin-right: 10px;"> <div style="display: flex; justify-content: space-between; align-items: center;"> <span>• ←→</span> </div> <div style="text-align: center; font-size: 24px; font-weight: bold;">0.0</div> <div style="text-align: right; font-size: 12px;">g</div> </div> <div style="margin-right: 10px;">  </div> </div> <div style="border: 1px solid black; padding: 5px; margin-top: 10px; text-align: center;"> <div style="font-size: 10px; margin-bottom: 5px;">CAL</div> <div style="font-size: 24px; font-weight: bold; letter-spacing: 2px;">d IFF.</div> </div> <div style="border: 1px solid black; padding: 5px; margin-top: 10px; text-align: center;"> <div style="font-size: 10px; margin-bottom: 5px;">CAL</div> <div style="font-size: 24px; font-weight: bold;">0.2</div> <div style="text-align: right; font-size: 12px;">g</div> </div>	<p>Press the [Cal] key to launch the span test sequence.</p> <p>The span adjustment sequence is evoked and the display switches in the order &lt; t. Int &gt;, &lt; t. 0 &gt;, &lt; t. F.S. &gt;.</p> <p>When span adjustment is completed, the display indicates &lt;dIFF.&gt; then the true value minus current span.          Please note that this value is the additive inverse of the "instrument error".          Press any key to return to measuring mode.</p> <hr/> <div style="border: 1px solid black; border-radius: 10px; padding: 2px 5px; display: inline-block; margin-bottom: 5px;">Reference</div> <p>For models LNA2202R, LNA3202R and LNA4202R, progress of the sequence is displayed in bar graph.</p>

## 10.5 Span Test with External Weight

<div style="border: 1px solid black; border-radius: 10px; padding: 5px; width: fit-content; margin: 0 auto;">Note</div>	<p>(1) The recommended external weight used for the span adjustment are those equivalent to:</p> <ul style="list-style-type: none"> <li>- OIML E2 for models LNA623, LNA623R, and LNA6202; and</li> <li>- OIML F1 for other models.</li> </ul> <p>(2) Use a weight for calibration that weighs 50% of the weighing capacity or heavier. To calibrate more accurately, use a weight that is close to the weighing capacity.</p> <p>(3) To ensure that the span test is carried out accurately, please note the following before starting this function:</p> <ul style="list-style-type: none"> <li>- Ensure that the balance installed properly levelled</li> <li>- Ensure that the equipment is not subject to environmental influences such as wind, vibration, temperature changes and changes in air pressure.</li> </ul>
---	--

<div style="border: 1px solid black; border-radius: 10px; padding: 5px; width: fit-content; margin: 0 auto;">Reference</div>	<p>(1) Set &lt;7. CA.&gt; to "4" before performing this function.</p> <p>(2) Pressing the [Output] key cancels the sequence midway.</p>
--	---

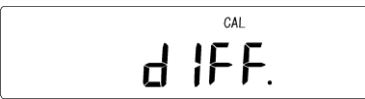
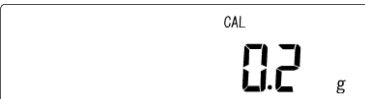
<p>1 Energise the balance for at least 5 minutes and load the balance a few times with a weight equivalent to the maximum capacity. Warm-up of more than 30 minutes is more recommended.</p>	
<p>2 Check that no load is on the weighing pan.</p> 	
<p>3 Launch the span test sequence.</p> 	<p>Press the [Cal] key to launch the span test sequence.</p>
<p>4 Zero-point calibration</p> 	<p>The display first indicates &lt; t. EXt &gt;, and then &lt;on 0&gt;, and the balance starts calibrating the zero point. (If the display indicates &lt;PuSH. F&gt;, press the [F] key).</p>
<p>5 Calibration of the capacity point</p> 	<p>The display switches to &lt;on F.S. &gt;. Load a calibration weight on the weighing pan. (If the display indicates &lt;PuSH. F&gt;, press the [F] key). The balance starts calibrating the weighing capacity point.</p>
<p>6 Completion of the span test sequence</p>  	<p>When span test is completed, the display indicates &lt;dIFF&gt; then the true value minus current span. Please note that this value is the additive inverse of the "instrument error". Press any key to return to measuring mode.</p>



## 10.6 Advice CAL

---

**Reference**

This function is available only on the models with internal calibration weight.

---

To maintain accurate measurements, calibration must be carried out when the temperature changes, when the air pressure changes and after long periods of time.

When "Advice CAL" is activated, the balance blinks the <CAL> sign in the display to inform you when span adjustment needs to be carried out.

To use this function, set <d. Ad.C> to "1" and set <7. CA.> to "1" (Span adjustment with internal calibration weight) or "3" (Span adjustment with external weight).

When the <CAL> sign starts to blink, press [CAL] key and perform span adjustment.





## 10.7 Calibration of the Internal Calibration Weight

This is a function to calibrate the built-in weight with an external calibration weight. This function is available on models LNA623R, LNA1202R, LNA2202R, LNA3202R, and LNA4202R of the LNA series.

<div style="border: 1px solid black; border-radius: 10px; padding: 5px; display: inline-block;">Note</div>	<p>(1) The recommended calibration weights used for the calibration are those equivalent to OIML E2.</p> <p>(2) Use a weight for calibration that weighs equal to the weighing capacity of the balance.</p> <p>(3) To ensure that the calibration is carried out accurately, please note the following before starting this function:</p> <ul style="list-style-type: none"> <li>- Ensure that the balance installed properly levelled</li> <li>- Ensure that the equipment is not subject to environmental influences such as wind, vibration, temperature changes and changes in air pressure.</li> </ul>
--	---

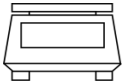
**Reference**

Pressing the [Output] key cancels the sequence midway.

<p>1 Check that no load is on the weighing pan.</p> 	
<p>2 Launch the advanced function setting mode.</p> <div style="display: flex; align-items: center; justify-content: center;"> <div style="text-align: center; margin-right: 10px;">               Press and hold down         </div> <div style="text-align: center; margin-right: 10px;">               Press and hold down         </div> <div style="text-align: center;"> <div style="border: 1px solid black; padding: 5px; display: inline-block; font-family: monospace; font-size: 24px;">Func2</div> <div style="margin: 10px 0;">↓ Key released</div> <div style="border: 1px solid black; padding: 5px; display: inline-block; font-family: monospace; font-size: 24px;">1. 1d. 0</div> </div> </div>	<p>Press the [F] key while holding down the [Zero/Tare] key.</p> <p>When &lt;Func2&gt; is displayed, release the key.</p> <p>The advanced function setting mode is activated, and the first item, &lt;1. 1d&gt; appears.</p>
<p>3 Select "Calibration of the Internal Calibration Weight".</p> <div style="display: flex; align-items: center; justify-content: center; margin-bottom: 10px;"> <div style="border: 1px solid black; padding: 5px; display: inline-block; font-family: monospace; font-size: 24px;">3. r.CA. 1</div> <div style="margin-left: 10px; font-size: 10px;">CAL</div> </div> <div style="display: flex; align-items: center; justify-content: center;"> <div style="text-align: center; margin-right: 10px;">               Press         </div> <div style="text-align: center;"> <div style="border: 1px solid black; padding: 5px; display: inline-block; font-family: monospace; font-size: 24px;">r.EF.CAL</div> <div style="margin-left: 10px; font-size: 10px;">CAL</div> </div> </div>	<p>Press the [F] key several times to go to &lt;3. r.CA.&gt;.</p> <p>Then press the [Zero/Tare] key to select "1" (execute) and press the [S] key. The display is changed to &lt;r.EF.CAL&gt;.</p>

4 Launch the Calibration of the Internal Calibration Weight sequence.

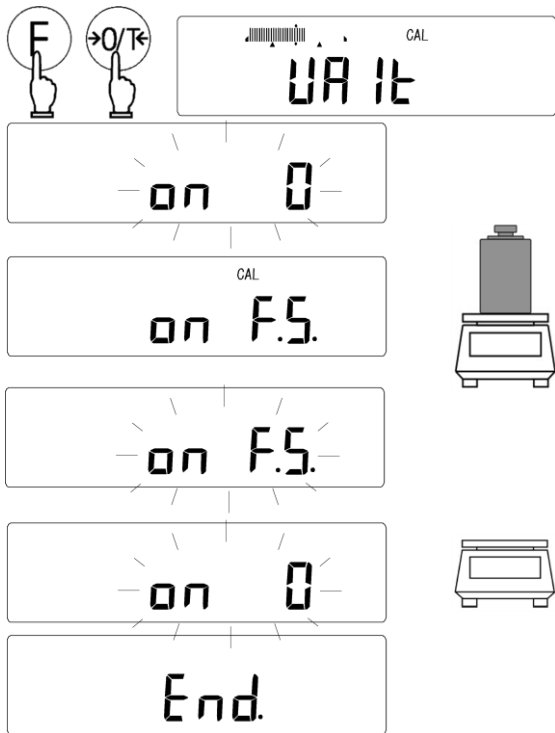

Press the [F] key while holding down the [Zero/Tare] key, and release the keys at the same time.

After <WAlt> indication, the display blinks <on 0>, and then indicates <on F.S.>.

When the display indicates <on F.S.>, put a calibration weight on the weighing pan carefully.

(If the display indicates <PuSH. F>, press the [F] key).

The display blinks <on F.S.>, and then indicates <on 0>.

Unload the calibration weight.



When calibration is completed, the display indicates <End>, and the indication reverts to measuring mode.

## 10.8 Setup and reflection of instrumental error of the external calibration weight

The instrumental error of the external calibration weight can be entered and reflected in span test and span adjustment.

By reflecting the instrumental error of an external calibration weight to be used in span adjustment or span test, a more accurate calibration can be performed. Enter the additive inverse of the instrumental error of the calibration weight (Enter in the unit of milligram.):

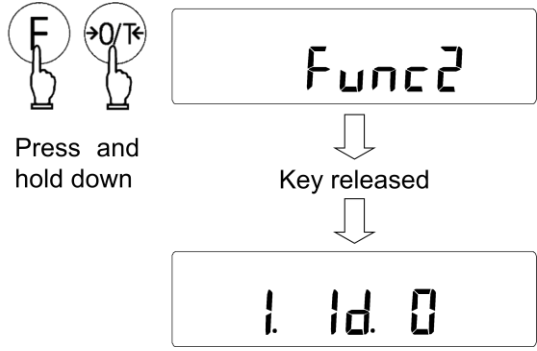
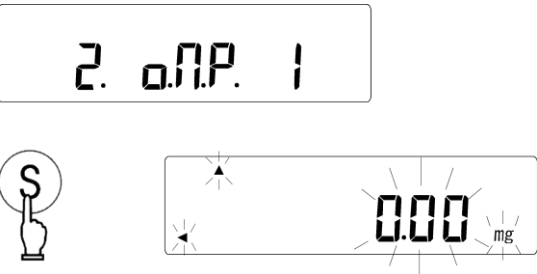
Additive inverse of the instrumental error of the calibration weight = Actual Weight - Nominal Value

<p>1 Launch the advanced function setting mode.</p> 	<p>Press the [F] key while holding down the [Zero/Tare] key.</p> <p>When &lt;Func2&gt; is displayed, release the key.</p> <p>The advanced function setting mode is activated, and the first item, &lt;1. 1d&gt; appears.</p>
<p>2 Select "Setup of instrumental error of the external calibration weight".</p> 	<p>Press the [F] key several times to go to &lt;2. o.M.P.&gt; and press the [Zero/Tare] key to select "1" (execute).</p> <p>Then press the [S] key. The previously registered "additive inverse of the instrumental error of the calibration weight" in milligrams is displayed together with the &lt;◀&gt; and &lt;▲&gt; indicators.</p> <p>If you want to skip the weight error value setup, press the [F] key, then the balance reverts to the measuring mode.</p>
<p>3 Launch setting sequence of the instrumental error of the calibration weight.</p> 	<p>Press the [Zero/Tare] key.</p> <p>The leftmost digit blinks first.</p>

4 Set the value.



Numeric value input by **F** and **0/T** or

Enter the value starting from a higher order digit with the following steps:

- 4-1. Select a number by pressing the [Zero/Tare] key, [**▲**] key, or [**▼**] key. Pressing the key switches between digits 0-9, minus sign, and decimal point.
- 4-2. Press the [**F**] key or [**▶**] key to shift to the next lower order digit.
- 4-3. Set the value by repeating steps 4-1 and 4-2.  
Pressing the [**◀**] key cancels the last input and returns to the previous digit entry.  
Pressing the [Output] key cancels the setting, and the display returns to the previous weight error value.
- 4-4. Press the [**S**] key to save the value.

The display changes to <3. rCA.> or <4. M.E.H.> of advanced function setting mode.

5 Adopt the instrumental error of the weight at the the span adjustment or span test with external calibration weight





Press the [**F**] key several times to go to <4. M.E.H.> and press the [Zero/Tare] key to select "1" to adopt the instrumental error of the weight at the the span adjustment or span test with external calibration weight.

- If more than one calibration weight is used in combination, enter the total error of the weights to be used.



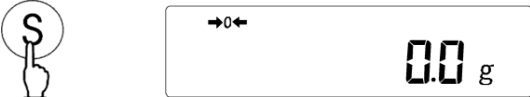
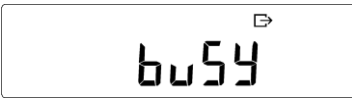

**Reference**

- The range of the instrumental error of the calibration weight should be within  $\pm 100.00$  mg. If any value outside the range is entered, it will result in the display of <r-Err>.

## 10.9 Output of span adjustment / span test results

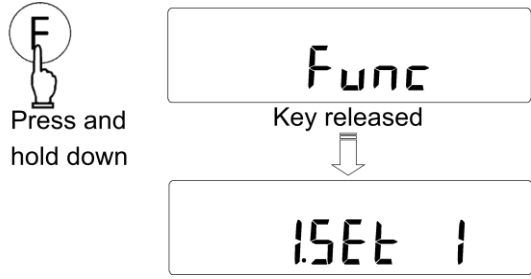
<p>1 Launch the basic function setting mode.</p>  <p>Press and hold down</p> <p>Key released</p>	<p>Press and hold down the [F] key. After &lt;Func&gt; is displayed, release the key. The function setting item &lt;1. SEt.&gt; is displayed.</p>
<p>2 Enable the "Output of span adjustment / span test results" function.</p> 	<p>Press the [F] key several times to go to &lt;E GLP&gt;, and press the [Zero/Tare] key to select "1" (enabled). Then press the [F] key to go to &lt;E l. out&gt;, and press the [Zero/Tare] key to select "1" (enabled).</p>
<p>3 Complete the setting of functions.</p> 	<p>Press the [S] key. "Output of span adjustment / span test results" function is activated, and the balance reverts to the measuring mode.</p>
<p>4 Perform span adjustment/span test.</p> 	<p>When span adjustment/span test is completed, the results are output with the date and time. During output, it indicates &lt;buSy →&gt; and it looks like the balance is frozen. However, this is a normal operation. Wait until the output operation is completed.</p>

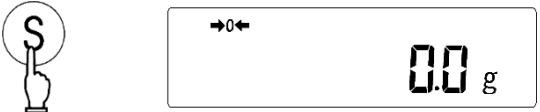
## 10.10 ISO/GLP/GMP form output of measurement data

<p>1 Launch the basic function setting mode.</p>  <p>Press and hold down</p>	<p>Press and hold down the [F] key. After &lt;Func&gt; is displayed, release the key. The function setting item &lt;1. SEt.&gt; is displayed.</p>
<p>2 Enable the “ISO/GLP/GMP form output of measurement data”.</p> 	<p>Press the [F] key several times to go to &lt;E GLP&gt;, and press the [Zero/Tare] key to select “1” (enabled). Then press the [F] key several times to go to &lt;E2. od.&gt;, and press the [Zero/Tare] key to select “1” (enabled).</p>
<p>3 Complete the setting of functions.</p> 	<p>Press the [S] key. “ISO/GLP/GMP form output of measurement data” function is enabled, and the balance reverts to the measuring mode.</p>
<p>4 Header output</p>  <p>Press and hold down</p>	<p>Press and hold down the [Output] key. The display indicates &lt;HEAD&gt; and a header is output.</p>
<p>5 Measurement data output</p>	<p>Measurement data is output in accordance with the setting of &lt;61. o.c.&gt;.</p>
<p>6 Footer output</p>  <p>Press and hold down</p>	<p>Press and hold down the [Output] key after the measurement is completed. The display indicates &lt;Foot&gt; and a footer is output.</p>

When a span adjustment or span test is successfully completed, the balance presents the results according to the following format. If span adjustment or a span test is not completed successfully, no data will be printed. The "X" entries in the following tables will vary with the model or the weight used.

When <4. M.E.H> of the advanced function setting mode is set to "1", the additive inverse of the "instrument error" of the external calibration weight suffixed by "ERR" is inserted.

**Reference** - The character code of Japanese is JIS X 0201.

(1) Span adjustment with internal calibration weight (Semi-automatic span adjustment)

1																
2	*	*	C	A	L	I	B	R	A	T	I	O	N	*	*	
3																
4	D	A	T	E	:	2	1	.	0	9	.	2	0	1	0	
5	T	I	M	E	:						1	6	:	5	6	
6	S	H	I	N	K	O					D	E	N	S	H	I
7	T	Y	P	E	:											
8						X	X	X	X	X	X	X	X	X	X	X
9	S	/	N	:		X	X	X	X	X	X	X	X	X	X	X
10	I	D	:						X	X	X	X	X	X	X	X
11																
12	C	A	L	:	I	N	T	E	R	N	A	L				
13	R	E	F	:												
14			X	X	X	X	X	X	X	X	X	X	X			g
15																
16	C	O	M	P	L	E	T	E								
17	D	A	T	E	:	2	1	.	0	9	.	2	0	1	0	
18	T	I	M	E	:						1	6	:	5	7	
19																
20	S	I	G	N	A	T	U	R	E							
21																
22																
23																
24	*	*	*	*	*	*	*	*	*	*	*	*	*	*	*	*
25																
26																
27																
28																

(2) Span adjustment with external weight

1																
2	*	*	C	A	L	I	B	R	A	T	I	O	N	*	*	
3																
4	D	A	T	E	:	2	1	.	0	9	.	2	0	1	0	
5	T	I	M	E	:						1	6	:	5	5	
6	S	H	I	N	K	O					D	E	N	S	H	I
7	T	Y	P	E	:											
8						X	X	X	X	X	X	X	X	X	X	X
9	S	/	N	:		X	X	X	X	X	X	X	X	X	X	X
10	I	D	:						X	X	X	X	X	X	X	X
11																
12	C	A	L	:	E	X	T	E	R	N	A	L				
13	R	E	F	:												
14			X	X	X	X	X	X	X	X	X	X	X			g
15																
16	C	O	M	P	L	E	T	E								
17	D	A	T	E	:	2	1	.	0	9	.	2	0	1	0	
18	T	I	M	E	:						1	6	:	5	6	
19																
20	S	I	G	N	A	T	U	R	E							
21																
22																
23																
24	*	*	*	*	*	*	*	*	*	*	*	*	*	*	*	*
25																
26																
27																
28																



(3) Span test with internal calibration weight

	1	2	3	4	5	6	7	8	9	10	11	12	13	14	15
1															
2	*	*	O	A	L	.	T	E	S	T	*	*	*	*	*
3															
4	D	A	T	E	:	2	1	.	0	9	.	2	0	1	0
5	T	I	M	E	:						1	6	:	5	6
6	S	H	I	N	K	O	.	D	E	N	S	H	I		
7	T	Y	P	E	:										
8						X	X	X	X	X	X	X	X	X	X
9	S	/	N	:		X	X	X	X	X	X	X	X	X	X
10	I	D	:					X	X	X	X	X	X	X	X
11															
12	C	A	L	.	I	N	T	.	T	E	S	T			
13	R	E	F	:											
14			X	X	X	X	X	X	X	X	X	X	X		g
15	D	I	F	F	:										
16			X	X	X	X	X	X	X	X	X	X	X		g
17															
18	C	O	M	P	L	E	T	E							
19	D	A	T	E	:	2	1	.	0	9	.	2	0	1	0
20	T	I	M	E	:						1	6	:	5	7
21															
22	S	I	G	N	A	T	U	R	E						
23															
24															
25															
26	*	*	*	*	*	*	*	*	*	*	*	*	*	*	*
27															
28															
29															
30															

(4) Span test with external weight

	1	2	3	4	5	6	7	8	9	10	11	12	13	14	15
1															
2	*	*	C	A	L	I	B	R	A	T	I	O	N	*	*
3															
4	D	A	T	E	:	2	1	.	0	9	.	2	0	1	0
5	T	I	M	E	:						1	6	:	5	5
6	S	H	I	N	K	O	.	D	E	N	S	H	I		
7	T	Y	P	E	:										
8						X	X	X	X	X	X	X	X	X	X
9	S	/	N	:		X	X	X	X	X	X	X	X	X	X
10	I	D	:					X	X	X	X	X	X	X	X
11															
12	C	A	L	.	E	X	T	E	R	N	A	L			
13	R	E	F	:											
14			X	X	X	X	X	X	X	X	X	X	X		g
15															
16	C	O	M	P	L	E	T	E							
17	D	A	T	E	:	2	1	.	0	9	.	2	0	1	0
18	T	I	M	E	:						1	6	:	5	6
19															
20	S	I	G	N	A	T	U	R	E						
21															
22															
23															
24	*	*	*	*	*	*	*	*	*	*	*	*	*	*	*
25															
26															
27															
28															

(5) Calibration of the Internal Calibration Weight

	1	2	3	4	5	6	7	8	9	10	11	12	13	14	15
1															
2	*	*	*	*	R	E	F	.	C	A	L	*	*	*	*
3															
4	D	A	T	E	:	2	1	.	0	9	.	2	0	1	0
5	T	I	M	E	:							1	6	:	5
6	S	H	I	N	K	O			D	E	N	S	H	I	
7	T	Y	P	E	:										
8						X	X	X	X	X	X	X	X	X	X
9	S	/	N	:		X	X	X	X	X	X	X	X	X	X
10	I	D	:						X	X	X	X	X	X	X
11															
12	R	E	F	:											
13				X	X	X	X	X	X	X	X	X	X	X	g
14															
15	C	O	M	P	L	E	T	E							
16	D	A	T	E	:	2	1	.	0	9	.	2	0	1	0
17	T	I	M	E	:							1	6	:	5
18															
19	S	I	G	N	A	T	U	R	E						
20															
21															
22															
23	*	*	*	*	*	*	*	*	*	*	*	*	*	*	*
24															
25															
26															
27															

(6) ISO/GLP/GMP form output of measurement data

(6-1) Header

	1	2	3	4	5	6	7	8	9	10	11	12	13	14	15
1															
2		S	H	I	N	K	O		D	E	N	S	H	I	
3	T	Y	P	E	:										
4						X	X	X	X	X	X	X	X	X	X
5	S	/	N	:		X	X	X	X	X	X	X	X	X	X
6	I	D	:						X	X	X	X	X	X	X
7															
8	S	T	A	R	T										
9	D	A	T	E	:	2	2	.	0	9	.	2	0	1	0
10	T	I	M	E	:							1	3	:	0
11															

(6-2) Footer

	1	2	3	4	5	6	7	8	9	10	11	12	13	14	15
1															
2	E	N	D												
3	D	A	T	E	:	2	2	.	0	9	.	2	0	1	0
4	T	I	M	E	:							1	6	:	0
5															
6	S	I	G	N	A	T	U	R	E						
7															
8															
9															
10	*	*	*	*	*	*	*	*	*	*	*	*	*	*	*
11															
12															
13															
14															

## 11 Cleaning the balance



Do not wet the AC adapter.

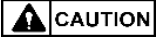

- (1) Do not remove any parts other than those described in this chapter. If the equipment needs to be dismantled and repaired, e.g. if foreign objects have been introduced inside, contact your local dealer.
- (2) Do not wash the balance with water.

Note

- (1) Take care not to let dust or liquid get inside the balance.
- (2) Take care not to apply excessive force to or impact the balance, especially the load-receptor.
- (3) Do not use volatile solvents to resin parts of the balance. If volatile solvents are used to clean the metal parts, care should be taken to ensure that they never contact the resin parts.

1 Disconnect the AC adapter from AC mains.

2 Disconnect the AC adapter and output cables.

If the area around the connector is contaminated with dust, remove the dust first and then disconnect the connectors, taking care not to let the dust get inside the connectors.

3 For models with a capacity of up to 620 g: Remove the windshield, measurement pan and pan base, and clean them respectively.

For models with a capacity of 1200 g to 15 kg: Remove the measurement pan and pan base, and clean them respectively.

For models with a capacity of 21 kg and 31 kg: Remove the measurement pan and clean it respectively.

If they are washed in water, wipe them well and allow them to dry.

Note

Spilled liquids remained on pan base and measurement pan will affect the weighing accuracy.

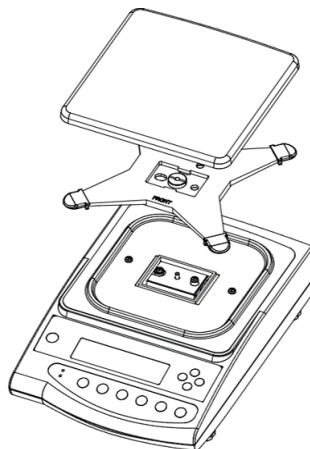

4 Wipe dirt from the balance with dry and soft cloth.

In the case of heavy soil, clean it with a piece of cloth slightly wet with neutral detergent.

## 12 Troubleshooting

Symptom	Cause	Measures to Take
There is no indication on the display.	<ul style="list-style-type: none"> <li>- The AC adapter is not connected.</li> </ul>	<ul style="list-style-type: none"> <li>→ Check that the AC adapter is connected. cf. "3. Assembling and Installation"</li> </ul>
The display is unstable. <M> remains flashing without changing.	<ul style="list-style-type: none"> <li>- The balance is s exposed to various environmental factors such as air currents, vibrations, electromagnetic wave etc.</li> <li>- The balance is situated on an unstable surface.</li> <li>- A foreign object is contacting the sample being measured, the measurement pan, or the tare.</li> <li>- The pan base is not properly secured.</li> </ul>	<ul style="list-style-type: none"> <li>→ Review the measurement environment. cf. "1.2 For More Precise Measurements"</li> <li>→ Ensure that no foreign objects are in contact. Ensure that the pan base is firmly screwed to the load receptor. cf. "3. Assembling and Installation"</li> </ul>
Weight indication contains an error.	<ul style="list-style-type: none"> <li>- Not correctly levelled.</li> <li>- The pan base is not properly secured.</li> <li>- The balance is s exposed to various environmental factors.</li> <li>- The balance has been moved to a new location.</li> <li>- Temperature or air pressure have changed since the last span adjustment.</li> </ul>	<ul style="list-style-type: none"> <li>→ Check the level. cf. "3. Assembling and Installation"</li> <li>→ Ensure that the pan base is firmly screwed to the load receptor. cf. "3. Assembling and Installation"</li> <li>→ Review the measurement environment. cf. "1.2 For More Precise Measurements"</li> <li>→ Execute span adjustment. cf. "10. Calibration of the Balance".</li> </ul>
<o-Err> is displayed.	<ul style="list-style-type: none"> <li>- The gross weight exceeded the maximum capacity of the balance (Measurable Range = Maximum Capacity - Tare Weight).</li> </ul>	<ul style="list-style-type: none"> <li>→ Check the gross weight.</li> <li>→ Replace the tare with a lighter one.</li> </ul>
<u-Err> is displayed.	<ul style="list-style-type: none"> <li>- The negative-value load is below the lower limit of indication.</li> </ul>	<ul style="list-style-type: none"> <li>→ Ensure that the pan base and measurement pan are properly set. cf. "3. Assembling and Installation"</li> <li>→ Ensure that no foreign objects are in contact.</li> </ul>
<L-Err> is displayed.	<ul style="list-style-type: none"> <li>- The unit weight is smaller than the minimum settable unit weight in counting mode.</li> </ul>	<ul style="list-style-type: none"> <li>→ Choose the samples of which unit weight is larger the minimum unit weight.</li> </ul>
<t-Err> is displayed.	<ul style="list-style-type: none"> <li>- The [S] key is pressed while &lt;*&gt; is not displayed at addition function.</li> </ul>	<ul style="list-style-type: none"> <li>→ Check the correct addition function procedure. cf. "6.5 Addition Function"</li> </ul>
<C-Err> is displayed. <b-Err> is displayed. <d-Err> is displayed.	<ul style="list-style-type: none"> <li>- System error</li> </ul>	<ul style="list-style-type: none"> <li>→ Contact your local dealer.</li> </ul>

<1-Err> is displayed.	<ul style="list-style-type: none"> <li>- The external calibration weight is less than 50% of the weighing capacity at span adjustment.</li> <li>- The external calibration weight is less than 95% of the weighing capacity at calibration of the internal calibration weight.</li> </ul>	→ Check the correct span adjustment procedure and use the appropriate calibration weight. cf. "10. Calibration of the Balance"
<2-Err> is displayed.	<ul style="list-style-type: none"> <li>- The size of the instrumental error of the external calibration weight exceeds 1.0% of the nominal weight.</li> </ul>	→ Check the correct span adjustment procedure and use the appropriate calibration weight. cf. "10. Calibration of the Balance"
<3-Err> is displayed.	<ul style="list-style-type: none"> <li>- Semi-automatic span adjustment has performed with something loaded on the weighing pan.</li> </ul>	→ Check correct span adjustment procedure. cf. "10. Calibration of the Balance"
<4-Err> is displayed.	<ul style="list-style-type: none"> <li>- An error over 1.0% was detected in semi-automatic span adjustment.</li> </ul>	→ Check correct span adjustment procedure. cf. "10. Calibration of the Balance"
<8-Err> is displayed.	<ul style="list-style-type: none"> <li>- The [Zero/Tare] key is pressed again after the data point has been deleted at statistics mode.</li> </ul>	→ The second last data point cannot be cancelled. The collection of data points has to be redone from the beginning. cf. "6.6 Statistics Mode"
<9-Err> is displayed.	<ul style="list-style-type: none"> <li>- Data point cannot be collected due to 0 g or negative weight input, or data overflow at statistics mode.</li> </ul>	→ Delete the statistical calculation result. The collection of data points has to be redone from the beginning. cf. "6.6 Statistics Mode"
<r-Err> is displayed.	<ul style="list-style-type: none"> <li>- Input value of instrumental error of the external calibration weight at &lt;2. o.M.P&gt; exceeds the maximum settable range of <math>\pm 100.00</math> mg.</li> </ul>	→ Use calibration weights with small instrumental error.
<A-Err> is displayed.	<ul style="list-style-type: none"> <li>- Abnormal end of semi-automatic span adjustment.</li> </ul>	→ Check correct span adjustment procedure. cf. "10. Calibration of the Balance"

# 13 Specifications

## 13.1 Metrological Specifications

### Individual model specifications:

Model	Max	d	Minimum unit weight in counting mode	Minimum reference weight in percentage mode	Calibration method	Pan size	
LNA623	620 g	0.001 g	0.001 g	0.1 g	- Span adjustment with external calibration weight	120 mm x 140 mm	
LNA1202	1200 g	0.01 g	0.01 g	1 g		200 mm x 200 mm	
LNA2202	2200 g	0.01 g	0.01 g	1 g			
LNA3202	3200 g	0.01 g	0.01 g	1 g			
LNA4202	4200 g	0.01 g	0.01 g	1 g			
LNA6202	6200 g	0.01 g	0.01 g	1 g			
LNA10002	10000 g	0.05 g	0.05 g	5 g			
LNA15001	15000 g	0.1 g	0.1 g	10 g			
LNA21001	21000 g	0.1 g	0.1 g	10 g			250 mm x 220 mm
LNA31001	31000 g	0.1 g	0.1 g	10 g			
LNA623R	620 g	0.001 g	0.001 g	0.1 g	- Semi-automatic span adjustment with built-in weight	120 mm x 140 mm	
LNA1202R	1200 g	0.01 g	0.01 g	1 g	- Span adjustment with external calibration weight	200 mm x 200 mm	
LNA2202R	2200 g	0.01 g	0.01 g	1 g			
LNA3202R	3200 g	0.01 g	0.01 g	1 g			
LNA4202R	4200 g	0.01 g	0.01 g	1 g			

### Common specifications:

- (1) Type of weighing sensor:  
Tuning fork sensor
- (2) Overload indication:  
<o-Err> is displayed if the indication exceeds weight capacity by 9 displayed scale intervals.
- (3) Zero point adjustment:
  - Initial zero setting
  - Semi-automatic zero-setting with [Zero/Tare] key
  - Automatic zero-tracking (Can be disabled via setting)
- (4) Tare device:
  - Initial tare subtraction
  - Semi-automatic tare balancing with [Zero/Tare] key
  - Type: Subtractive tare (Tare reduces the weighing range for net loads)
  - Range: Beyond the zero-setting range and up to the maximum capacity (Max)
- (5) Guaranteed temperature range for metrological performance:  
5 °C to 35 °C

## 13.2 Functional Specifications

- (1) Display ..... Vacuum fluorescent display (VFD)  
7-segment  
Maximum digits indication: 8 digits  
Segment height: 12.5 mm
- (2) Output ..... Bi-direction RS232C output, output for peripherals
- (3) Supported printer ..... CBM910II
- (4) Temperature and humidity ranges... 5 to 35 °C, 80%rh or lower
- (5) Altitude ..... 2000 m and under the sea level
- (6) Location of use ..... Indoor use only
- (7) Pollution degree ..... 2
- (8) Ratings ..... AC adapter jack: 12 V $\overline{\text{---}}$  350 mA  
Dedicated AC adapter:  
Input 100-240 V $\sim\pm 10\%$  50-60 Hz 0.6 A  
Output 12 V $\overline{\text{---}}$  1.0 A 12.0 W
- (9) Electromagnetic Compatibility ..... Immunity: Industrial electromagnetic environment
  - Performance Level: The balance does not display stable values or output values beyond a value corresponding to 10 d.
  - Permissible Loss of Performance: The balance indication may become unstable and may exceed 10 d temporarily due to electromagnetic interference, but it does not lead to inaccurate weight indication readings or outputs.Emission: Class B
- (10) Options ..... Retrofit options:
  - Hanger fitting for hanging measurement (For 1200 g-15 kg capacity models)Factory options:
  - Relay contact output option
  - RS422 option (Replaces the standard RS232C output)

### 13.3 Display, readability and capacity by each weighing unit

Unit			LNA623/ LNA623R	LNA1202/ LNA1202R	LNA2202/ LNA2202R	LNA3202/ LNA3202R	LNA4202/ LNA4202R
Name	Display						
gram	g	Max d	620 0.001	1200 0.01	2200 0.01	3200 0.01	4200 0.01
kilogram	kg	Max d	0.62 0.000001	1.2 0.00001	2.2 0.00001	3.2 0.00001	4.2 0.00001
carat	ct	Max d	3100 0.005	6000 0.05	11000 0.05	16000 0.05	21000 0.05
ounce	oz	Max d	21 0.00005	42 0.0005	77 0.0005	110 0.0005	140 0.0005
pound	lb	Max d	1.3 0.000005	2.6 0.00005	4.8 0.00005	7 0.00005	9.2 0.00005
troy ounce	oz t	Max d	19 0.00005	38 0.0005	70 0.0005	100 0.0005	130 0.0005
pennyweight	dwt	Max d	390 0.001	770 0.01	1400 0.01	2000 0.01	2700 0.01
grain	GN	Max d	9500 0.02	18000 0.2	33000 0.2	49000 0.2	64000 0.2
tael troy (Hong Kong)	ti	Max d	16 0.00005	32 0.0005	58 0.0005	85 0.0005	110 0.0005
tahil (Singapore, Malaysia)	ti and ▶ of upper right	Max d	16 0.00005	31 0.0005	58 0.0005	84 0.0005	110 0.0005
tael (Taiwan)	ti and ▶ of middle right	Max d	16 0.00005	32 0.0005	58 0.0005	85 0.0005	110 0.0005
momme	mom	Max d	160 0.0005	320 0.005	580 0.005	850 0.005	1100 0.005
tola (India)	to	Max d	53 0.0001	100 0.001	180 0.001	270 0.001	360 0.001



Unit			LNA6202	LNA10002	LNA15001	LNA21001	LNA31001
Name	Indication						
gram	g	Max d	6200 0.01	10000 0.01	15000 0.1	21000 0.1	31000 0.01
kilogram	kg	Max d	6.2 0.00001	10 0.00001	15 0.0001	21 0.0001	31 0.0001
carat	ct	Max d	31000 0.05	50000 0.5	75000 0.5	100000 0.5	150000 0.5
ounce	oz	Max d	210 0.0005	350 0.002	520 0.005	740 0.005	1000 0.005
pound	lb	Max d	13 0.00005	22 0.0002	33 0.0005	46 0.0005	68 0.0005
troy ounce	oz t	Max d	190 0.0005	320 0.002	480 0.005	670 0.005	990 0.005
pennyweight	dwt	Max d	3900 0.01	6400 0.05	9600 0.1	13000 0.1	19000 0.1
grain	GN	Max d	95000 0.2	150000 1	230000 2	320000 2	470000 2
tael troy (Hong Kong)	tl	Max d	160 0.0005	260 0.002	400 0.005	560 0.005	820 0.005
tahil (Singapore, Malaysia)	tl and ▶ of upper right	Max d	160 0.0005	260 0.002	390 0.005	550 0.005	820 0.005
tael (Taiwan)	tl and ▶ of middle right	Max d	160 0.0005	260 0.002	400 0.005	560 0.005	820 0.005
momme	mom	Max d	1600 0.005	2600 0.02	4000 0.05	5600 0.05	8200 0.05
tola (India)	to	Max d	530 0.001	850 0.005	1200 0.01	1800 0.01	2600 0.01

## 13.4 Conversion Table of Units

Unit	gram	kilogram	carat	ounce	pound	troy ounce	pennyweight
1 gram	1	0.001	5	0.03527	0.00220	0.03215	0.64301
1 kilogram	1000	1	5000	3.527	2.20	32.15	643.01
1 carat	0.2	0.0002	1	0.00705	0.00044	0.00643	0.12860
1 ounce	28.34952	0.02834952	141.74762	1	0.06250	0.91146	18.22917
1 pound	453.59237	0.45359237	2267.96185	16	1	14.58333	291.66667
1 troy ounce	31.10348	0.03110348	155.51738	1.09714	0.06857	1	20
1 pennyweight	1.55517	0.00155517	7.77587	0.05486	0.00343	0.05	1
1 grain	0.06480	0.0000648	0.32399	0.00229	0.00014	0.00208	0.04167
1 tael troy (Honk Kong)	37.429	0.037429	187.145	1.32027	0.08252	1.20337	24.06741
1 tahlil (Singapore, Malaysia)	37.79936	0.03779936	188.99682	1.33333	0.08333	1.21528	24.30556
1 tael (Taiwan)	37.5	0.0375	187.5	1.32277	0.08267	1.20565	24.11306
1 momme	3.75	0.00375	18.75	0.13228	0.00827	0.12057	2.41131
1 tola (India)	11.66380	0.0116638	58.31902	0.41143	0.02571	0.37500	7.5

unit	grain	tael troy (Hong Kong)	tahlil (Singapore, Malaysia)	tael (Taiwan)	momme	tola
1 gram	15.43236	0.02672	0.02646	0.02667	0.26667	0.08574
1 kilogram	15432.36	26.72	26.46	26.67	266.67	85.74
1 carat	3.08647	0.00534	0.00529	0.00533	0.05333	0.01715
1 ounce	437.5	0.75742	0.75	0.75599	7.55987	2.43056
1 pound	7000	12.11874	12	12.09580	120.95797	38.88889
1 troy ounce	480	0.83100	0.82286	0.82943	8.29426	2.66667
1 pennyweight	24	0.04155	0.04114	0.04147	0.41471	0.13333
1 grain	1	0.00173	0.00171	0.00173	0.01728	0.00556
1 tael troy (Honk Kong)	577.61774	1	0.99020	0.99811	9.98107	3.20899
1 tahlil (Singapore, Malaysia)	583.33333	1.00990	1	1.00798	10.07983	3.24074
1 tael (Taiwan)	578.71344	1.00190	0.99208	1	10	3.21507
1 momme	57.87134	0.10019	0.09921	0.1	1	0.32151
1 tola (India)	180	0.31162	0.30857	0.31103	3.11035	1

## 13.5 Open source software used in this product

Software name: BMP2-Sensor-API

Version: v1.0.1

URL: <https://github.com/BoschSensortec/BMP2-Sensor-API>

Copyright (c) 2021 Bosch Sensortec GmbH. All rights reserved.

BSD-3-Clause

Redistribution and use in source and binary forms, with or without modification, are permitted provided that the following conditions are met:

1. Redistributions of source code must retain the above copyright notice, this list of conditions and the following disclaimer.
2. Redistributions in binary form must reproduce the above copyright notice, this list of conditions and the following disclaimer in the documentation and/or other materials provided with the distribution.
3. Neither the name of the copyright holder nor the names of its contributors may be used to endorse or promote products derived from this software without specific prior written permission.

THIS SOFTWARE IS PROVIDED BY THE COPYRIGHT HOLDERS AND CONTRIBUTORS "AS IS" AND ANY EXPRESS OR IMPLIED WARRANTIES, INCLUDING, BUT NOT LIMITED TO, THE IMPLIED WARRANTIES OF MERCHANTABILITY AND FITNESS FOR A PARTICULAR PURPOSE ARE DISCLAIMED. IN NO EVENT SHALL THE COPYRIGHT HOLDER OR CONTRIBUTORS BE LIABLE FOR ANY DIRECT, INDIRECT, INCIDENTAL, SPECIAL, EXEMPLARY, OR CONSEQUENTIAL DAMAGES (INCLUDING, BUT NOT LIMITED TO, PROCUREMENT OF SUBSTITUTE GOODS OR SERVICES; LOSS OF USE, DATA, OR PROFITS; OR BUSINESS INTERRUPTION) HOWEVER CAUSED AND ON ANY THEORY OF LIABILITY, WHETHER IN CONTRACT, STRICT LIABILITY, OR TORT (INCLUDING NEGLIGENCE OR OTHERWISE) ARISING IN ANY WAY OUT OF THE USE OF THIS SOFTWARE, EVEN IF ADVISED OF THE POSSIBILITY OF SUCH DAMAGE.





