

Intrinsically Safe Explosion-Proof Electronic Scale

GZII-(B)Ex Series

Operation Manual

Instructions

- To ensure safe and proper use of the scale, please read this manual carefully.
- After reading this manual, store it in a safe place near the scale, so you can review it as needed.

VIBRA

SHINKO DENSHI CO., LTD.

CAUTION

Thank you for purchasing the **GZII Series** Intrinsically Safe Explosion-Proof ElectronicScale.

Use apparatus correctly according to Operation manual, otherwise it will cause dangerous for life and cause disaster like factory explosion by the gas ignition. In the case of improper use, no safety shall be guaranteed.

Before operation, the law and technical standard of the country where apparatus is operated shall be confirmed whether target gas suits the gas classification, otherwise it will be dangerous for life and cause disaster like factory explosion by the gas ignition.

Any modification of apparatus shall be strictly prohibited. In the case of modification of apparatus, no safety shall be guaranteed at all.

Power supply shall be provided through an over current protector. (16A)

Only connect SELV circuits which are DI/RI from hazardous live to the I/O interfaces of the equipment.

Install equipment so that the power supply cord can be pulled out without hindrance in event of emergency.

IECEX CERTIFICATE

Certificate No.: IECEx KEM 08.0016

Type of Protection: ia

Marking: Ex ia II B T4

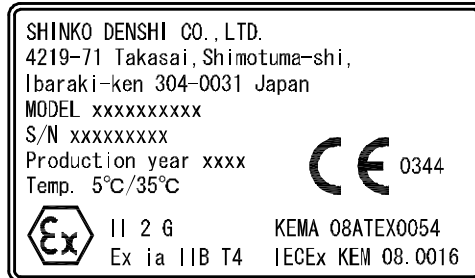

STANDARDS: IEC 60079-0:2004 Edition: 4.0

IEC 60079-11:2006 Edition: 5

Test Report: NL/KEM/ExTR08.0012/00

EQUIPMENT: Ta: +5°C to +35°C

POWER SUPPLY: GZ II-B, EZ II-B and EZ-B Series:

1.5 V Manganese dry cell batteries National/Panasonic

Type R14P (NR). (6 non-rechargeable)

GZ II, EZ II and EZ Series:

Maximum values $U_i = 43$ V; $I_i = 170$ mA; $P_i = 0.931$ W; $C_i = 7.1$ nF; $L_i = 0.75$ mH.

The insulation between an intrinsically safe circuit and the frame of the (electrical) apparatus is not guaranteed. Avoid excess voltage.

EC-TYPE EXAMINATION CERTIFICATE

Certificate No.: KEMA 08ATEX0054

Marking:

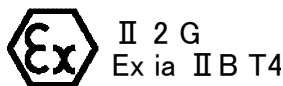

STANDARDS: EN 60079-0:2006

EN 60079-11:2007

Test Report: KEMA No. 211076300

EQUIPMENT: Ta: +5°C to +35°C

POWER SUPPLY: GZ II-B, EZ II-B and EZ-B Series:

1.5 V Manganese dry cell batteries National/Panasonic

Type R14P (NR). (6 non-rechargeable)

GZ II, EZ II and EZ Series:

Maximum values $U_i = 43$ V; $I_i = 170$ mA; $P_i = 0.931$ W; $C_i = 7.1$ nF; $L_i = 0.75$ mH.

The insulation between an intrinsically safe circuit and the frame of the (electrical) apparatus is not guaranteed. Avoid excess voltage.

Table of Contents

CAUTION	i
IECEX CERTIFICATE	ii
Table of Contents	iii

Conditions and Cautions for Installation

1 Conditions of Installation (for the Explosion-Proof Type).....	1, 2
2 Cautions about Installing the Scale	3

Names and Functions of the Component Parts

1 Outer View.....	4
2 Details of the Panel	5

Installation

1 Checking Supplied Items	6
2 Cautions about Installation	7
3 Assembling a Small-Sized Scale	8
4 Assembling a Medium-Sized Scale	9
5 Horizontal Adjustment of the Scale.....	11
6 Installation of the Power Supply Box.....	12
7 How to Replace Batteries	13

Basic Operation of the Scale

1 Getting Started and Checking Operation	14
2 Taring and Weighing	15
3 Notes on Handling the Scale.....	16

Addition Function

1 Select the Addition Function.....	17
2 Procedure for Making Addition and Displaying the Sum	18, 19

Limit Function

1 Select the Limit function.....	20, 21
2 Setting by Weighing Actual Samples ..	22, 23
3 Setting by Entering Values	24, 25

Functions

1 Functions and How They Work.....	26, 27
2 Checking the Set Value	28
3 Change the Setting.....	29

Calibration of the Scale

.....	30, 31
-------	--------

Troubleshooting

.....	32
-------	----

Standard Specifications

1 Common Specifications.....	33
2 Configuration of Each Model	34

Conditions and Cautions for Installation

1 Conditions of Installation (for the Explosion-Proof Type)

◆ Power supply box type

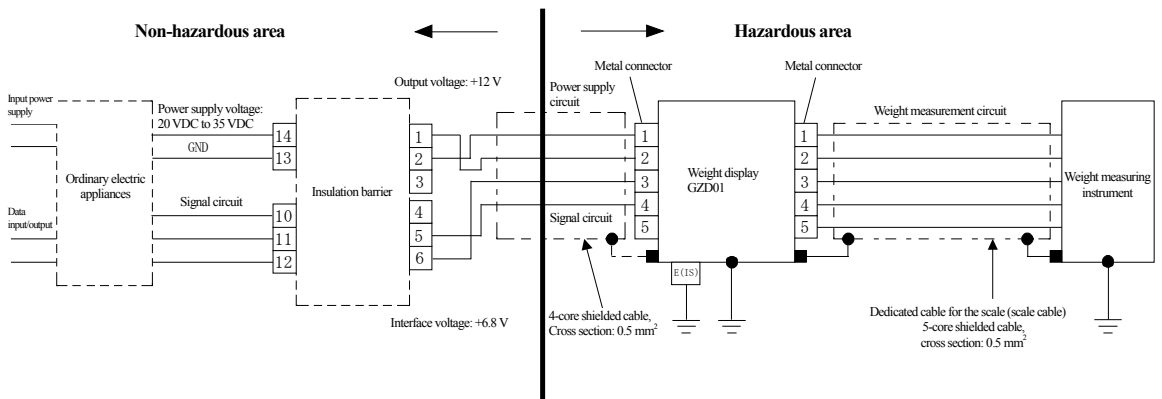

Input

- ◇ $P_i = 0.931$ [W]
- ◇ $U_i = 43$ [V]
- ◇ $I_i = 170$ [mA]
- ◇ $C_i = 7.1$ [nF]
- ◇ $L_i = 0.75$ [mH]
- ◇ Conditions for ordinary appliances connected to the insulation barrier:
The voltage to ground of the input power supply and in the instrument shall not exceed 250 VAC, 50/60 Hz or 250 VDC during normal operation and even during a fault.
- ◇ The E(1S) shall be an intrinsically safe explosion-proof grounding pin for maintenance.

◆ Dry-cell battery type

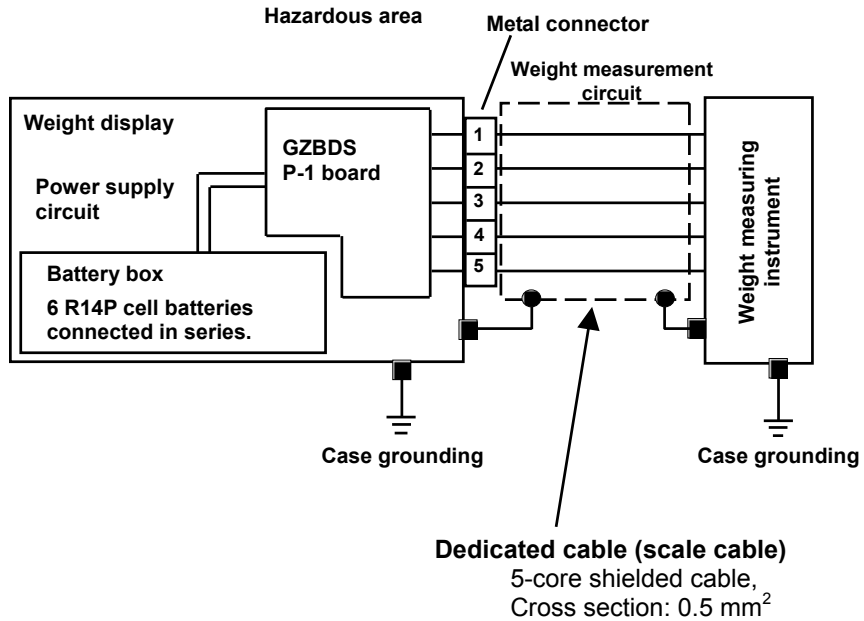

- ◇ Inductance of the dedicated cable for the scale (scale cable):
0.01 mH or less
- ◇ Capacitance of the dedicated cable for the scale (scale cable):
0.005 μ F or less
- ◇ Dry-cell batteries to be stored in the battery box:
R14P from National/Panasonic (Connect 6 cells in series.)
- ◇ Battery replacement in a hazardous area is prohibited.

2

Cautions about Installing the Scale

1. Be sure to replace dry cell batteries of the dry-cell battery type scale in a non-hazardous area.
The type of the cell batteries is limited to C-size red manganese batteries (type: R14P from National / Panasonic).
2. The power cable of the power supply box type is laid between the hazardous area and the non-hazardous area.
Be sure to have the specified gas flow prevention work performed for the lead-in section of the cable.
3. Never set the power supply box and the barrier in the hazardous area.
4. The standard power supply box is provided with a 5-m power cable.
Options of extended cables are available in increments of 5 m to a maximum of 100 m. Use of our company's cables is recommended for the power supply box.
5. Establish a ground for the case when it is deteriorated by pressure.

Names and Functions of the Component Parts

1 Outer View

◆ Small-sized scale (2 kg to 12 kg)

GZ II-(B)2000Ex

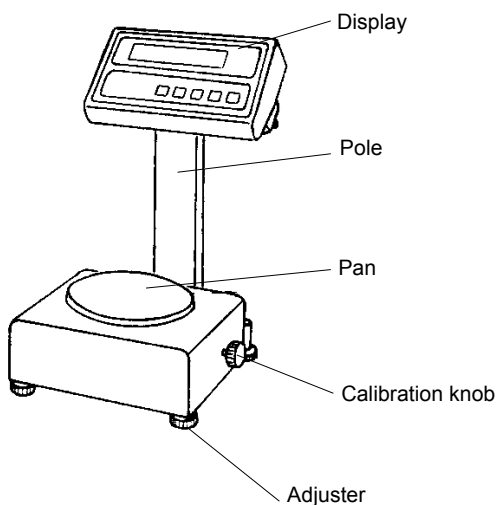

GZ II-(B)6000Ex to (B)12KEx

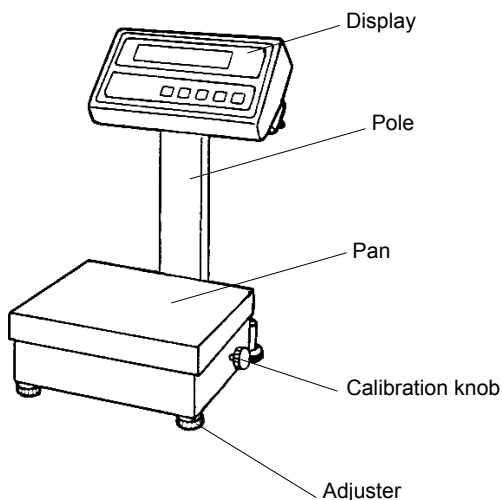

◆ Medium-sized scale (30kg to 60kg)

GZ II-(B)30KEx to 60KEx

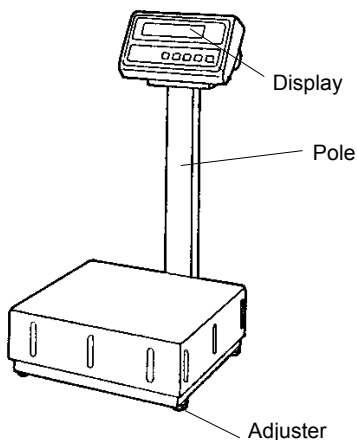

◆ Power supply box

(Provided for the power supply box type only)

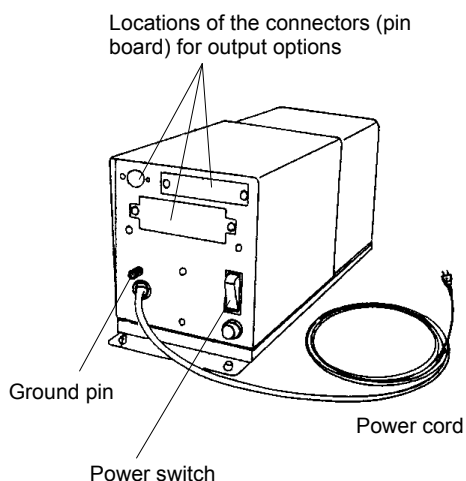

2

Details of the Panel

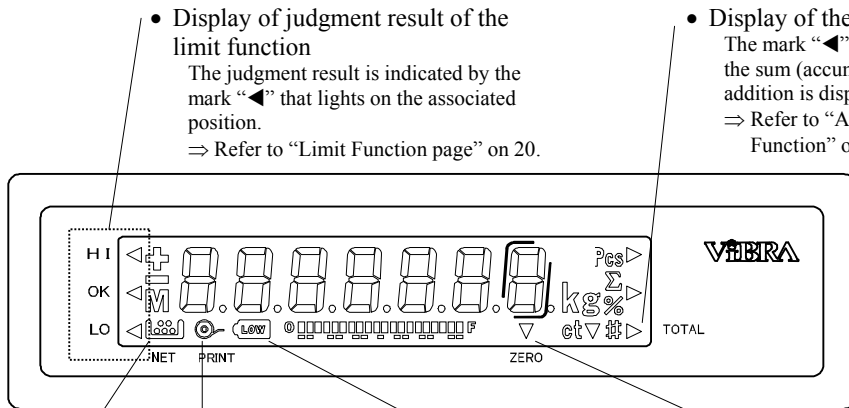

- Display of judgment result of the limit function
The judgment result is indicated by the mark “◀” that lights on the associated position.
⇒ Refer to “Limit Function page” on 20.

- Display of the sum
The mark “◀” lights and the sum (accumulation) of addition is displayed.
⇒ Refer to “Addition Function” on page 17.

- Taring in progress
This mark lights when the weight of the container (tare) is subtracted.
Taring and Weighing
⇒ Refer to “Taring and Weighing” on page 15.

- Print
This mark lights when data is printed or output.
⇒ Refer to “Functions” on page 26 and after.
(This mark stays out on the dry-cell battery type.)

- Battery level
This mark blinks when the battery capacity drops to the predetermined level.
⇒ Refer to “How to Replace Batteries” on page 13 and after.
(This mark stays out on the power supply box type.)

- Zero point
This mark lights when the correct zero point is reached.
⇒ Refer to “Taring and Weighing” on page 15.



On/Off

Press this key to turn the scale on or off. ⇒ Refer to “Getting Started and Checking Operation” on page 14.
This key can be disabled on the power supply box type. ⇒ Refer to “Functions” on page 26 and after.



Print

Press this key for output to the printer. Or use this key as an output command key for an installed output device.
⇒ Refer to “Functions” on page 26 and after.



Set

Limit key: Press this key to start the limit function. ⇒ Refer to “Limit Function” on page 20 and after.
Add key: Press this key for addition (accumulation) of data. ⇒ Refer to “Addition Function” on page 17.
This key works as an interrupt key during selection of a function or during setting of the limit function.



Function

Set key: Press this key to set a limit value of the limit function or to move the digit for value entry when setting numerical values.
⇒ Refer to “Limit Function” on page 20 and after.

Switch key: Press this key to display a sum (accumulation). ⇒ Refer to “Addition Function” on page 17.
Press this key to start or end the selection of a function. ⇒ Refer to “Functions” on page 26 and after.









Zero/Tare

Zero/Taring key: Press this key to zero a readout. ⇒ Refer to “Taring and Weighing” on page 15.
The “Taring in progress” mark lights when you zero 1.5 % or more of the weighing capacity.

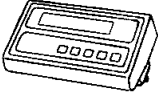
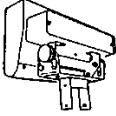
Installation

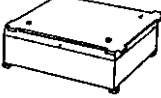
1 Checking Supplied Items

Check the supplied items of the model you purchased and the accessories of the power supply part shown in the following table. If any items are missing or broken, please contact immediately the retailer of the scale or our Sales Office.

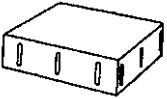
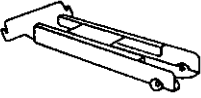
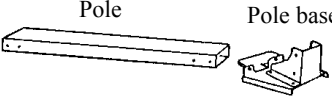
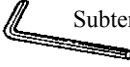
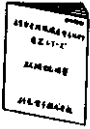
Accessory	Small-sized model		Medium-sized model
	Round pan base	Square pan base	
Display			 * A metal part for angle adjustment is provided only for the medium-sized and large-sized models.
Scale (main body)			
Pan base			Not supplied for this model.
Pan		 Sub-pan base	
Pole			 Pole Pole base
Wrench	Not supplied for this model.		 Subtense = 4 mm
Operation Manual			

◆ Accessories of the Power Supply Unit

◆ Power supply box type

- (1) Power supply box ×1
with spare fuses

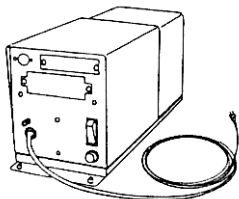

◆ Dry-cell battery type

- (1) C-size manganese dry-cell battery (R14P) ×6
※R14P(NR):National / Panasonic

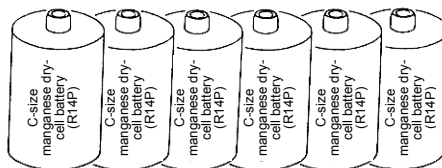

- (2) Power supply cable (5 m) ×1



- (2) Small wrench ×1
(Subtense: 2 mm)



2 Cautions about Installation

Install the scale in the best environment available. Using the scale in any of the environments shown below may cause weighing errors or instrument failures:

- 1** A loose floor on which the scale sinks when loaded with a sample



- 2** An unstable base or a location subjected to vibration



- 3** A location close to an air-conditioner

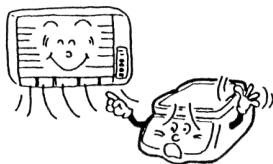

- 4** A location exposed to direct sunlight

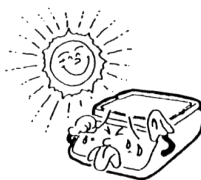

- 5** A location subjected to abrupt changes of ambient temperatures or humidity



3 Assembling a Small-Sized Scale

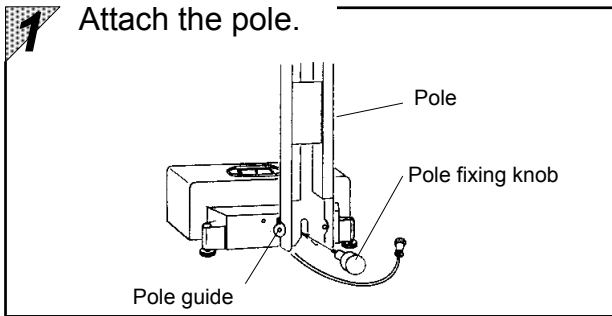

Install the accessory pole to the rear guide with the pole knob.

Unless the pole fits the guide correctly or the pole knob screw is not tightened enough, the display may tilt or flicker.

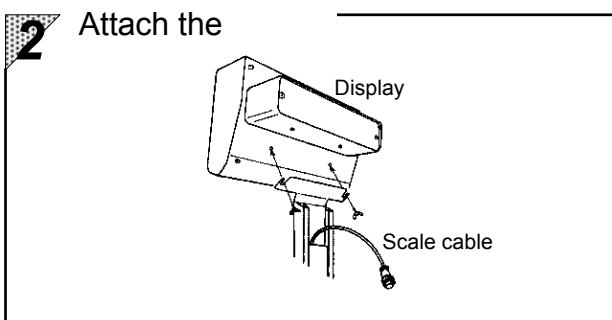

Pass the scale cable in the pole and attach the display to the pole.

Connect the scale cable and the power cable to the display.

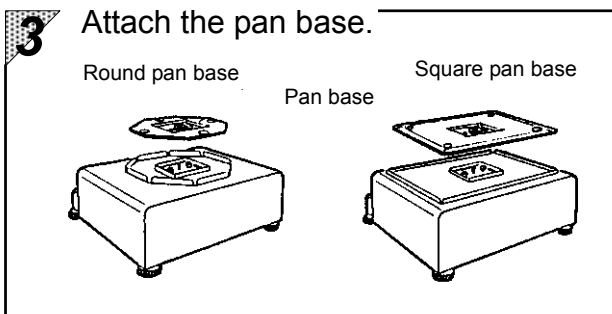

Set the pan base with its screw hole aligned to the projection on the main body and tighten the screw with a screwdriver or an appropriate coin.

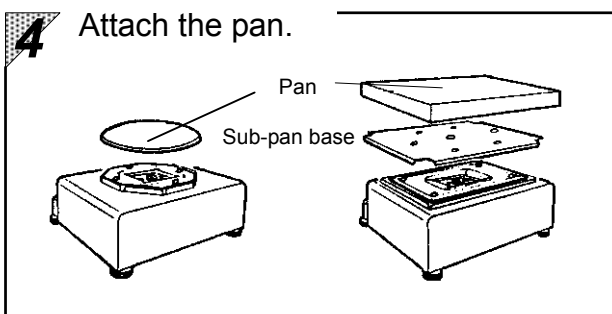

Attach the pan.

When a square pan is used, a sub-pan base is added under the pan.

* Models GZII-(B)30KCEX to (B)60KCEX are separate types that do not require pole installation. The pan base is preinstalled in the main body.

4 Assembling a Medium-Sized Scale

If you do not use the pole, remove the display stay and assemble the scale as indicated on the next page.

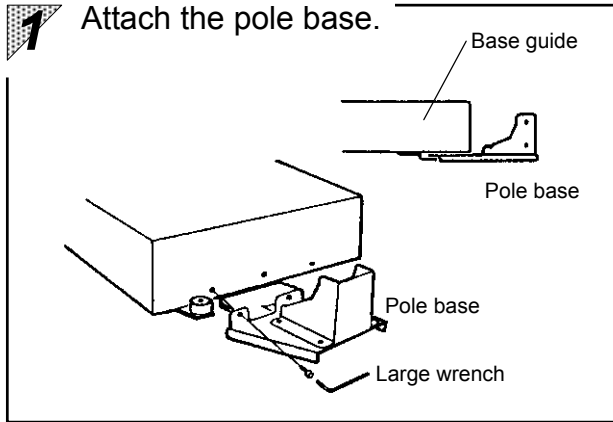

Install the accessory pole base to the base guide at the bottom of the scale with the supplied large wrench. Unless the pole base fits the guide correctly, the pole base cannot be installed on the scale.

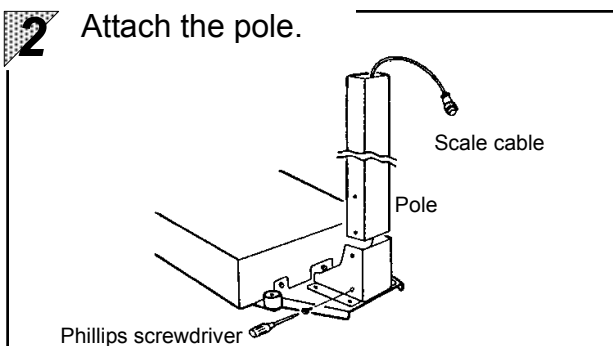

Pass the scale cable under the pole (from the wider side of the fitting hole). Next, attach the pole to the pole base.

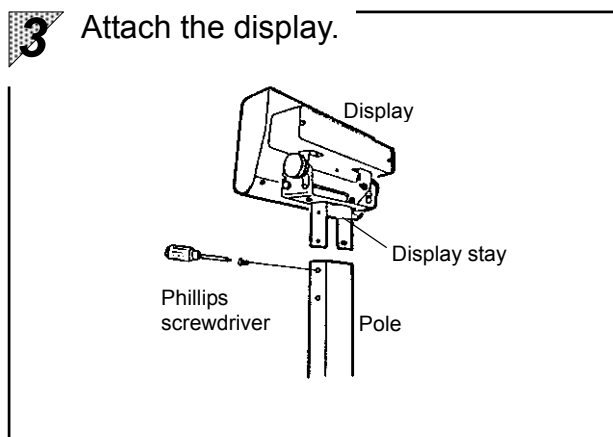

Attach the display to the pole and connect the scale cable.

For the power supply box type, connect the power cord too.

4 Attach the pan.

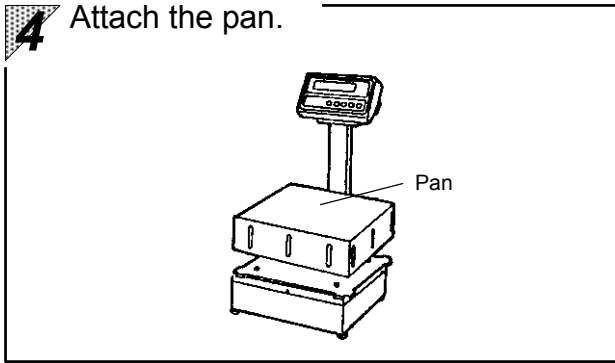

Place the pan on the scale.

5 Horizontal Adjustment of the Scale

◆GZ II-(B)2000Ex to (B)12KEx

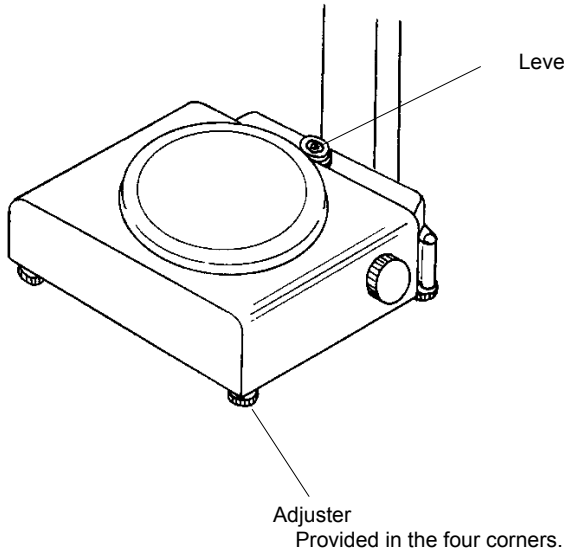

◆GZ II-(B)30KEx to (B)60KEx

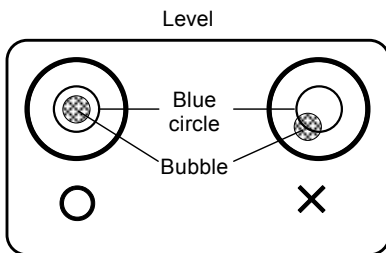
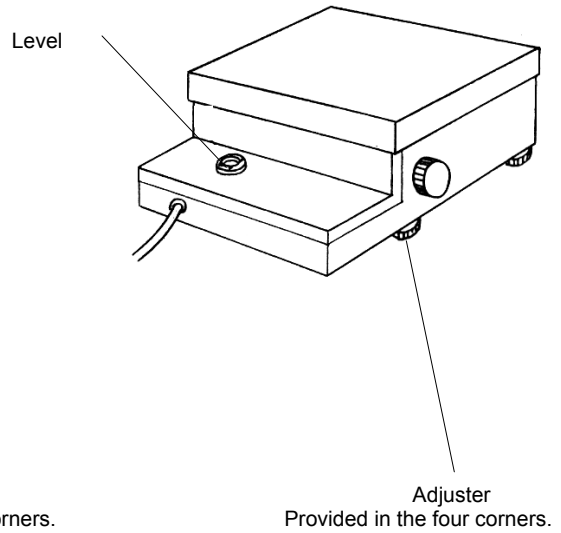

Rotate the four adjusters until the bubble in the level fits within the blue circle.
Press the four corners to check for rattling of each adjuster.

6 Installation of the Power Supply Box

This section applies to the scale of the power supply box type. Jump to the next section when you use a dry-cell battery type.

First finish the cable installation work. Be sure to have the specified gas flow prevention work performed for the lead-in section of the cable because the section is laid between the hazardous area and the non-hazardous area.

Be sure to extract the power cord from the wall socket before installing the power supply box.

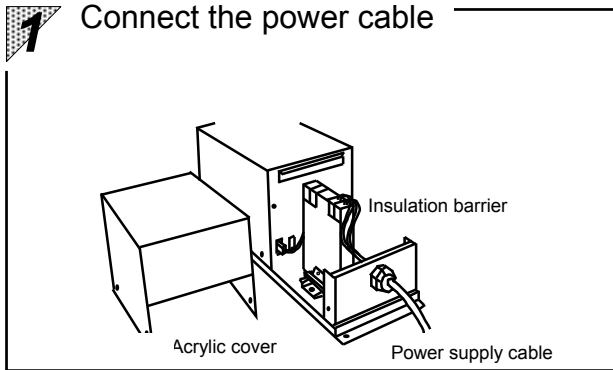

Remove the acrylic cover and connect the power cable.
Connect the cable to the correct position referring to the following figure.

Wiring diagram of the barrier

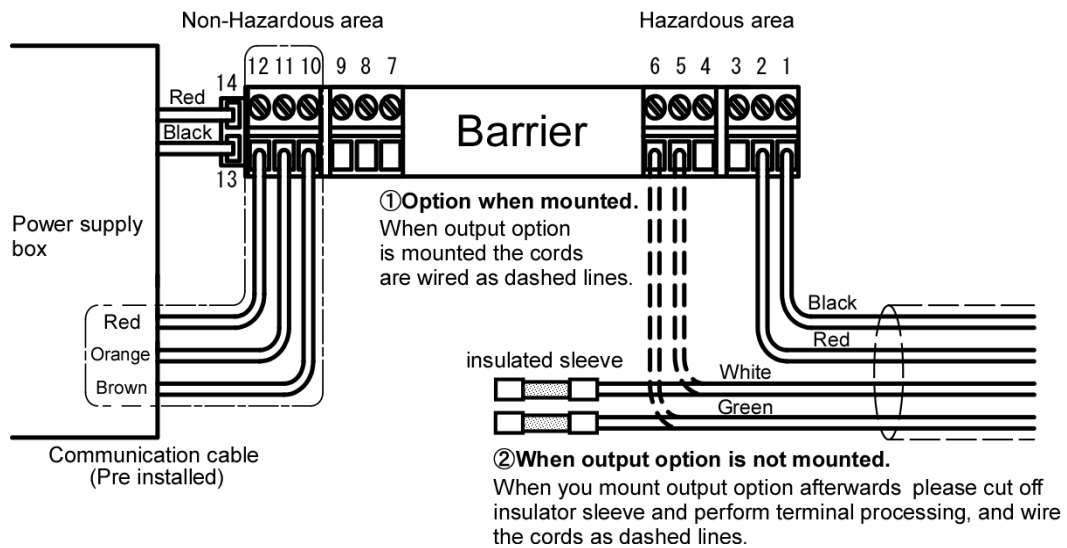

7 How to Replace Batteries

This section applies to the scale of the dry-cell battery type. Return to the previous section when you use a power supply box type. Be sure to replace batteries in a non-hazardous area.

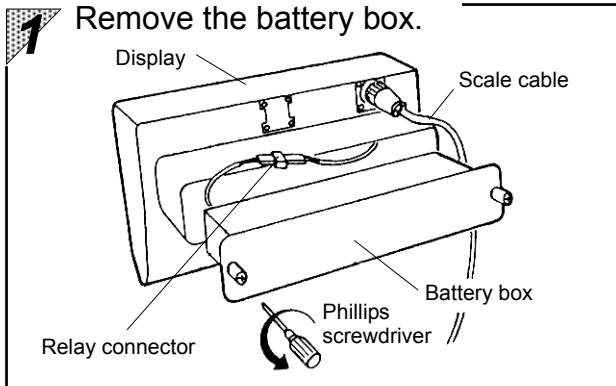

Loosen the screw in the rear of the display and the battery box can be removed.

Remove the relay connector in the battery box.

Do not pull the cable since it may cause wire breakage. Hold and pull the connectors when you disconnect the cables.

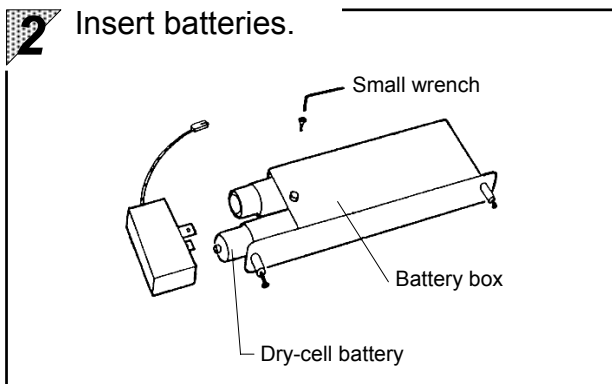

Remove the battery box cover with the small wrench in the accessory kit.

Replace the batteries in the correct direction. Install the cover with the small wrench.

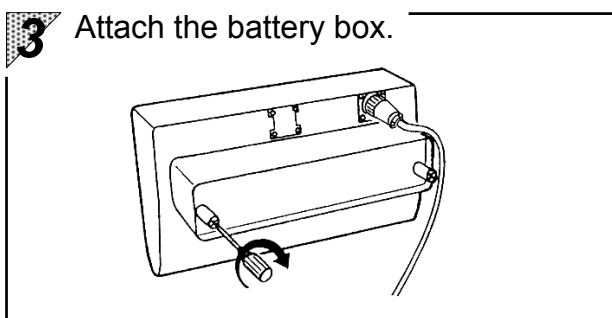

Connect the relay connector of the battery box and install it on the display.

Important

The type of the cell batteries is limited to C-size red manganese batteries (type R14P(NR) National / Panasonic). Use of other batteries is strictly prohibited because they may not be of the required explosion-proof performance.

Basic Operation of the Scale

1 Getting Started and Checking Operation

As for the power-supply box type, first turn on the power switch in the power supply box.

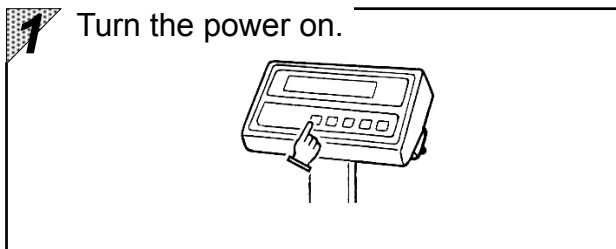

Press the  key on the panel, and all the indicators light up, showing that the instrument is operating.

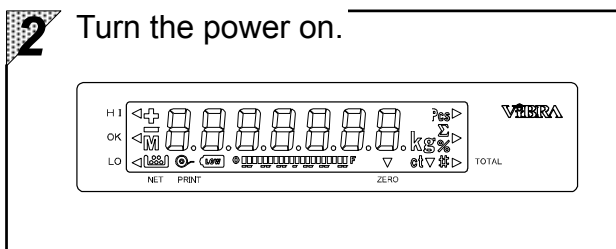

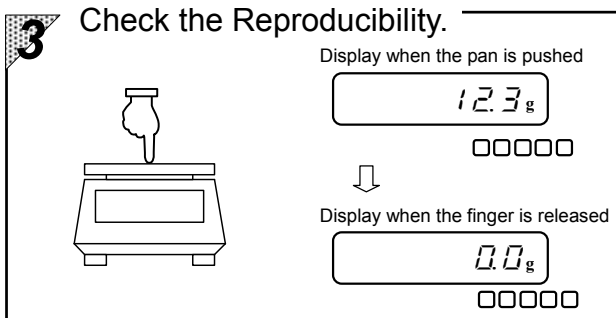

At this time, check that no LEDs nor LED segments stay out.

After a few seconds, zero is displayed in the weight display.

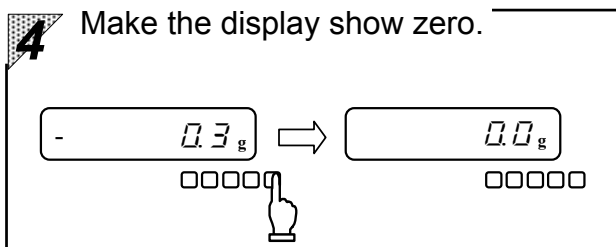

Push the pan slightly using your finger to check that the display readout changes. Also check that zero is indicated in the display after the finger is released.



If the display readout does not become zero, press the  key to make the display show zero. ⇒ Refer to “Set the zero point.”

* For setting the zero point, set the scale to display zero when nothing is placed on the pan or approximately 1.5% of the weighing capacity is loaded.

2 Taring and Weighing

1 Taring operation

Place the tare (container) on the pan.

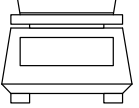

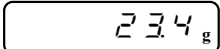

The weight of the tare (container) is displayed.

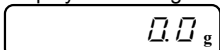

↓

Display after taring





○○○○○

Place the tare (container) on the pan and press the  key, and the readout changes to zero. ⇒ Refer to “Taring.”

2 Measure the net weight.

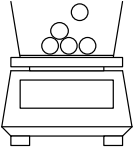
Place the sample in the container.



The net weight is





○○○○○

When samples are placed in the container, the net weight of the sample is displayed.

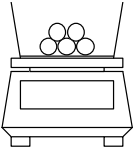
3 Taring operation

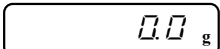

Display after taring





○○○○○

Press the  key, and the readout changes to zero. ⇒ Refer to “Taring.”

4 Place additional samples.

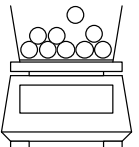
Place additional samples in the container.



Result of weighing the added samples

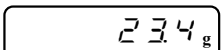

○○○○○

When additional samples are placed in the container, the weight of only the added samples is displayed.

Key points

1. When the zero point is accurately reached, the zero point is flagged with a “▼” mark. (This mark disappears when another value is displayed.)
2. If approximately 1.5% of the weighing capacity is displayed as zero, the mark that indicates that taring is ongoing (“”) is displayed. At this time, the weighable range is narrowed.

Weighable range = original weighing capacity – weight of the tare

3 Notes on Handling the Scale

1 Load or unload samples on the scale carefully. Do not apply mechanical shocks to the instrument.



2 Do not permit any material to be inserted beneath the pan.



3 Do not leave a load over the weighing capacity on the scale (“E r r” displayed). The weighing capacity = the weight of the tare + the weight of the sample



4 Calibration is recommended after installation or relocation or when the scale is used after being stored for an extended period of time. Refer to “Calibration of the Scale” on page 30 and after.

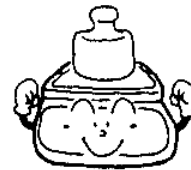

5 Be sure to replace batteries in the non-hazardous area. The type of the cell batteries is limited to C-size red manganese batteries (type: R14P).

6 Do not attempt to repair the scale because it may cause the explosion-proof performance to be lost and is very dangerous.

7 Do not attempt to modify the scale because it may cause the explosion-proof performance to be lost and is very dangerous.

8 Any faults or breakage cause by erroneous handling, repair, or modification by the user is not covered by the warranty.

Addition Function

The addition function sums the results of weighing samples subdivided into several parts. This function is convenient when the total weight is checked at the time of filling, blending, or consecutive weighing small quantities.

1 Select the Addition function

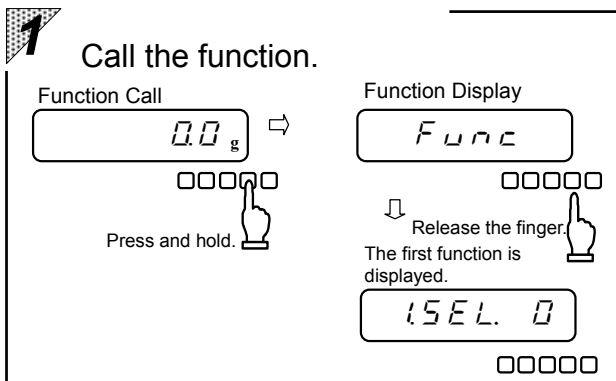

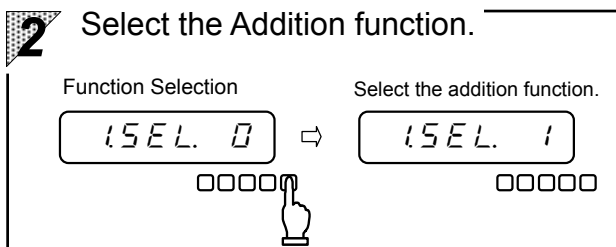

Press and hold the  key for approximately 4 seconds. When “Func” is displayed, release the finger. Now the function setting mode is assumed and the first item “1SEL. 0” (Function Selection) is displayed. ⇒ For details, refer to pages 26 and 27.

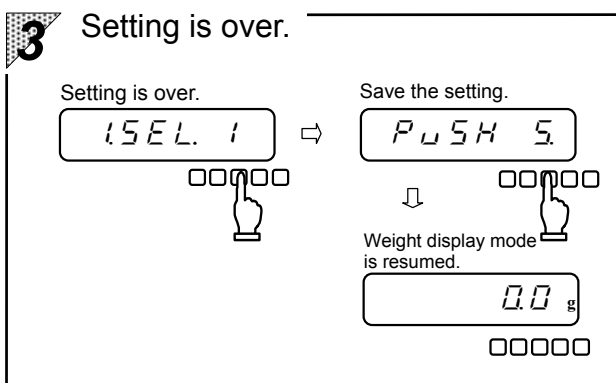

Press the  key, and the rightmost value changes. Then select the addition function “1.”



Press the  key, and the set value is saved and “PUSH 5.” is displayed. Press the  key again, and the setting process is terminated and the weight display mode is resumed.

2 Procedure for Making Addition and Displaying the Sum

1 Weigh the samples.

Place the sample in the container. The net weight is measured.

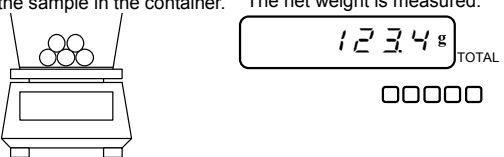

Place samples on the scale for weighing.

2 Add the weight of the samples.

The result of the addition is displayed.

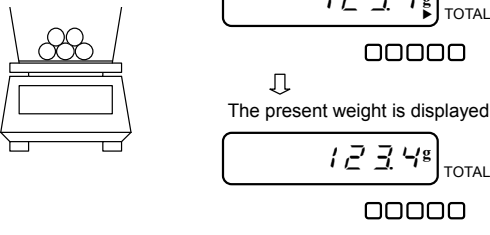

The present weight is displayed.

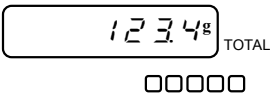

Press the  key.
 The sum is displayed together with the “▶” mark for temporary display of the addition result. After approximately 3 seconds, the original display is resumed.

3 Set the zero point.

Display after the zero point was set.



When additional samples are placed in the container, press the  key so that zero is shown in the display.

4 Place additional samples.

Place additional samples in the container. Result of weighing the added samples



When additional samples are placed in the container, the weight of only the added samples is displayed.

5 Add the weight of the samples.

The result of the addition is displayed.

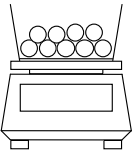

+ 199.9 g TOTAL
00000

↓

The present weight is displayed.

76.5 g TOTAL
00000

Press the  key.
The sum is displayed together with the “▶” mark for temporary display of the addition result. After approximately 3 seconds, the original display is resumed.

6 Display the sum value.

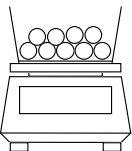

The sum value is displayed.



+ 199.9 g TOTAL
00000

The present weight is displayed.

76.5 g TOTAL
00000

Press the  key.
The final sum is displayed together with the “▶” mark.
When the  key is pressed again, the original display is resumed.

7 Clear the sum value.

The sum value is displayed.



+ 199.9 g TOTAL
00000

The sum value is displayed.

+ 0.0 g TOTAL
00000

While the sum is displayed, press the  key.
Zero is displayed, indicating that the sum is cleared.

Key points

1. The addition operation is enabled only when zero is displayed. If new samples are added after the present samples are unloaded, check beforehand that zero is displayed.
2. When the addition operation is over, press the  key to clear the sum value. This can prevent the sum by a new operation from being added to the preceding one if two or more addition operations are performed consecutively.
3. When “E - E r r” is displayed by pressing the  key, it indicates that you performed double addition, minus addition, or zero addition.

Limit Function

The limit function allows the scale to store the upper and lower limit values for judgment of whether the measurement result falls within the limit values. This function is very convenient for identifying defective items or weighing predetermined quantities.

◆ Methods of Entering Limit Values

The following two methods are available and they can be used alone or in combination.

(1) Setting by weighing actual samples: Weigh the actual samples for the lower and upper limit values on the scale and save the weights.

(2) Setting by entering values: Use a key to enter the values of the lower and upper limits and save the values.

* The entered limit values are stored in memory and are not erased by power-off.

* The judgment result is indicated by HI, OK, or LO flagged with a “◀” mark on the panel.

HI: The measured value is greater than the upper limit value.....Upper limit value < measured value

OK: The measured value is within the limit values.....Upper limit value ≥ measured value ≥ lower limit value

LO: The measured value is smaller than the lower limit value.....Lower limit value > measured value

1 Select the Limit function

1 Call the function.

Function Call

0.0 g

□□□□

Press and hold.

Function Display

Func

□□□□

Release the finger.

The first function is displayed.

1SEL. 0

□□□□

Press and hold the  key for approximately 4 seconds. When “Func” is displayed, release the finger.

Now the function setting mode is assumed and the first item “1SEL. 0” (Function Selection) is displayed.

(⇒ For details, refer to pages 26 and 27.)

2 Select the Limit function.

Function Selection

1SEL. 0

□□□□

Select the Limit function.

1SEL. 2

□□□□

Press the  key, and the rightmost value changes. Then select the limit function “2.”

3 Select a condition.

Function Selection

Select a condition.

Display: Condition
 1.Li.1: Always judge.
 1.Li.2: Judge only when the scale is stable.

Press the key, and the next item (condition) is displayed.

Press the key, and the rightmost value changes. Then select the value that you want to set.

4 Select a range to cover.

Function Selection

Select a range to cover.

Display: Range to cover
 12.L.0: Detect when the limit is exceeded by 5 divisions or less.
 12.L.1: Detect when the limit is exceeded by 50 divisions or less.
 12.L.2: Detect both when the limit is exceeded and when it is not reached.

Press the key, and the next item (range to cover) is displayed.

Press the key, and the rightmost value changes. Then select the value that you want to set.

5 Select a setting type.

Function Selection

Select a judgment type.

Display: Setting type
 13.P.n.1: Set both upper and lower limits.
 13.P.n.2: Set only the lower limit.
 13.P.n.3: Set only the upper limit.

Press the key, and the next item (setting type) is displayed.

Press the key, and the rightmost value changes. Then select the value that you want to set.

6 Setting is over.

Setting is over.

Save the setting.

Weight display mode is resumed.



Press the key, and the setting is saved and “PUSH 5” is displayed.

Press the key again, and the setting process is terminated and the weight display mode is resumed.

2 Setting by Weighing Actual Samples

If zero is not shown in the display, press the  key to make the display show zero before starting the procedure. If a container is used, perform the taring process to make the display show zero.

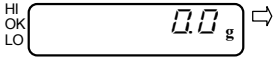
1 Start setting the limit values.

Call the setting.  

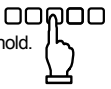
Press and hold. 

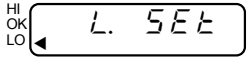
Start entering the lower limit value. 

Release the finger. 

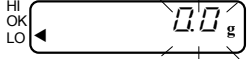
The set value is displayed. 

Press and hold the  key for approximately 3 seconds. When “L. SET” is displayed, release the finger. Now the lower limit value can be set. The judgment display “LO” is flagged with the “◀” mark and blinks.

2 Set the lower limit value.

Place the sample on the scale. 

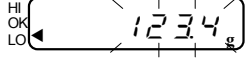
Set the lower limit value. 



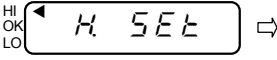

Place the sample for the lower limit value on the scale and press the  key. The display disappears temporarily. When the lower limit value is saved, the display blinks.

3 Start setting the upper limit value.

Start setting the upper limit value. 

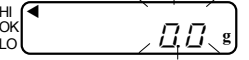

The set value is displayed. 



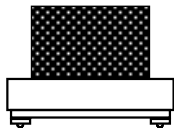

Press the  key, and the upper limit value can be set. “H. SET” is displayed temporarily and the judgment display “HI” is now flagged with the “◀” mark.

4 Set the upper limit value.

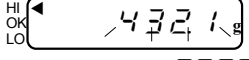
Place the sample on the scale. 

Set the upper limit value. 



Place the sample for the upper limit value on the scale and press the  key. The display disappears temporarily. When the upper limit value is saved, the display blinks.

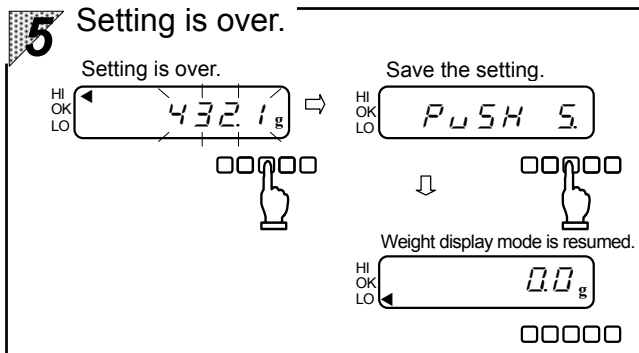

Press the  key, and the setting is saved and "PUSH S." is displayed.

Press the  key again, and the setting process is terminated and the weight display mode is resumed.

Key points

- The operation procedure differs as follows depending on which judgment type is selected:
 When "Set only the lower limit" is selected ⇒ Skip steps 3 and 4 and end with step 5.
 When "Set only the upper limit" is selected ⇒ "H. S E t ." is displayed in step 1 and therefore you need not perform step 2.
- If a limit value has already been entered, the set value is displayed after "L. S E t ." or "H. S E t ." If a new limit is set, the value changes.
- If a negative value is set as a limit, the range to cover is set as "Detect both when the limit is exceeded and when it is not reached" including the minus value. If no limits are set, judgment is not performed.
 ⇒ Refer to "Functions and How They Work" on pages 26 and 27.
- If all of the judgment displays "HI," "OK," and "LO" are flagged with the "◀" mark, the lower limit value is greater than the upper limit value. Try the procedure again.
- You can switch the process of "setting by weighing actual samples" to "setting by entering values" at some midpoint in the process.
 The process of "setting by entering values" is enabled if you shift to step 2 of the process after setting limit values by weighing actual samples. This method is convenient when you change a value set by the process of "setting by weighing actual samples."
- You can switch the process of "setting by entering values" to "setting by weighing actual samples" at some midpoint in the process.
 The process of "setting by weighing actual samples" is enabled if you place a sample on the scale and press the  key after setting limits by entering values.

3 Setting by Entering Values

1 Start setting the limit values.

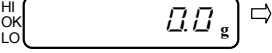
Call the setting.  →

Press and hold. 

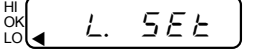
Start entering the lower limit value.  ↓

Release the finger. 

The set value is displayed. 

Press and hold the  key for approximately 3 seconds. When “L. SET” is displayed, release the finger. Now the lower limit value can be set.

The judgment display “LO” is flagged with the “◀” mark and blinks.

2 Start the process of “setting by entering values.”

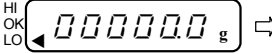
Start the process of “setting by entering values.”  →

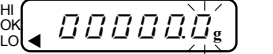
The digit for value entry is displayed. 

Press the  key, and the process of “setting by entering values” is enabled with all digits displayed. Only the LSD blinks, indicating that it is the digit for value entry.

3 Enter a value to set.

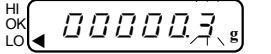
Enter a value to set. 



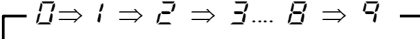

The value changes each time the  key is pressed.

Select a value to set.



4 Change the digit for value entry.

Change the digit for value entry. 





Press the  key, and the digit for value entry changes.

The MSD is used to set the plus or minus sign (+ or -).

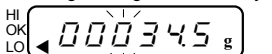

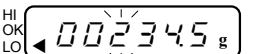
5 Enter the lower limit value.

Change the digit for value entry.  →

Enter a value to set. 



Repeat the steps 3 and 4.

Select the digit for value entry with the  key and select a value to set with the  key for entry of the lower limit value.

6 Setting of the lower limit value is over.

Setting of the lower limit value is over. The display stays out while the value is being saved.

The set value is displayed.

The diagram shows a sequence of two states. In the first state, the display shows 'M' and is blank. A hand is shown pressing the 'Set' key. In the second state, the display shows '2345 g' and the 'HI' indicator is lit. The 'Set' key is also shown being pressed.

When the entering of the lower limit value is over, press the key. The display disappears temporarily. When the lower limit value is saved, the display blinks.

7 Start setting the upper limit value.

Start setting the upper limit value. The set value is displayed.

The diagram shows a sequence of two states. In the first state, the display shows 'H. SET' and the 'HI' indicator is lit. A hand is shown pressing the 'Set' key. In the second state, the display shows '0.0 g' and the 'HI' indicator is lit. The 'Set' key is also shown being pressed.

Press the key, and the upper limit value can be set. "H. SET" is displayed temporarily and the judgment display "HI" is now flagged with the "◀" mark.

8 Start the process of "setting by entering values."

Start the process of "setting by entering values." The digit for value entry is displayed.

The diagram shows a sequence of two states. In the first state, the display shows '000000 g' and the 'HI' indicator is lit. A hand is shown pressing the '>0/Tare<' key. In the second state, the display shows '000000 g' with the LSD digit blinking and the 'HI' indicator is lit. The '>0/Tare<' key is also shown being pressed.

Press the key, and the process of "setting by entering values" is enabled with all digits displayed. Only the LSD blinks, indicating that it is the digit for value entry.

9 Entering and setting of the upper limit value are over.

Change the digit for value entry. Enter a value to set.

Setting of the upper limit value is over. Weight display mode is resumed.

The diagram shows a sequence of four states. 1. Display shows '00078.9 g' with the LSD digit blinking. A hand presses the 'Function' key. 2. Display shows '00678.9 g' with the LSD digit blinking. A hand presses the '>0/Tare<' key. 3. Display shows 'M' and is blank. A hand presses the 'Set' key. 4. Display shows '678.9 g' and the 'HI' indicator is lit. The 'Set' key is also shown being pressed.

As in the case of entering the lower limit value, select the digit for value entry with the key and select a value to set with the key for entry of the upper limit value. When the entering of the upper limit value is over, press the key. The display disappears temporarily. When the upper limit value is saved, the display blinks.

10 Setting is over.

Setting is over. Save the setting. Weight display mode is resumed.

The diagram shows a sequence of three states. 1. Display shows '678.9 g' and the 'HI' indicator is lit. A hand presses the 'Set' key. 2. Display shows 'PUSH 5.' and the 'HI' indicator is lit. A hand presses the 'Set' key. 3. Display shows '0.0 g' and the 'HI' indicator is lit. The 'Set' key is also shown being pressed.

Press the key, and the set value is saved and "PUSH 5." is displayed. Press the key again, and the setting process is terminated and the weight display mode is resumed.

Functions

This scale is provided with the functions shown in the table below. These functions can be adjusted according to your work conditions. ⇒ Refer to “Checking the Set Value” on page 28 and “Changing the Setting” on page 29.

1 Functions and How They Work

1-1 Basic Functions

* Shaded parts indicate factory default settings.

Functional item	Display	How the function works		
Additional Function	1SEL	0	OFF: Disables the function.	
		1	Enables the addition function.	
		2	Enables the limit function. ⇒ Refer to Section 2.2 “Details of the Limit Function.”	
Autozero (Zero tracking)	2 RD	0	OFF: Disables this function.	
		1	ON: Enables this function.	
Response Speed	3 RE	0	Display speed Fast ↑ ↓ Slow	* If “0” or “1” is set, the displayed values may flicker. * If the scale is influenced by wind or vibration, set “4” or “5.”
		1		
		2		
		4		
		5		
Stability Judgment	4 SD	1	Judgment precision Loose ↑ ↓ Strict	Judgment time Fast ↑ ↓ Slow
		2		
		4		
Autopower-off	5 RP	0	This function can be used only for the dry-cell battery type	OFF: Disables this function (for continuous use).
		1		ON: Turns off the power automatically when approximately 3 minutes have elapsed.
Interface	5 IF	0	Reserved (Output is stopped.)	
		1	6-digit format	
		2	7-digit format	
External Taring	6 ET	1	Operation by contact inputs	
		2	Operation by commands input from a PC or other devices	
ON/OFF Key Control	7 PC	0	Disables the ON/OFF key.	
		1	Enables the ON/OFF key.	

* The functions from the Interface “5 IF, 1” and after are not provided for the dry-cell battery type. When you select the Additional Function “1SEL, 2” or the Interface “5 IF, 1” or “5 IF, 2,” refer to the description on the next page.

1-2 Details of the Limit Function

When you select the Additional Function “15 E L. 2,” the following functional items are displayed before the Autozero function.

Functional item	Display		Description
Condition	11 E. a.	1	Always judge. (Judgment is also made when the scale is unstable.)
		2	Judge only when the scale is stable. (Judgment is not made when the scale is unstable.)
Range to Cover	12 L. a.	0	Do not detect when the limit is exceeded by +5 divisions or less (including the minus value).
		1	Do not detect when the limit is exceeded by 50 divisions or less (including the minus value).
		2	Detect both when the limit is exceeded and when it is not reached, including the minus value.
Judgment Type	13 P. a.	1	Set both the upper and lower limits.
		2	Set only the lower limit.
		3	Set only the upper limit.

* Shaded parts indicate factory default settings.

1-3 Details of the Interface

When you select the Interface “5 1 F 1,” the process ends with “5 2 b. L.” and then the next function is displayed.

When you select the Interface “5 1 F 2,” the items up to “5 3 P R.” are displayed and then the next function is displayed.

Functional item	Display		Description
Output Control	5 1 a. c.	0	Stop output.
		1	Output continuously at all times. *1
		2	Output continuously if stable. (Stop output if unstable.) *1
		3	Output once when the  key is pressed.
		4	Output once when the scale is stable. Output when the sample is unloaded to cause the display to indicate a value below zero, and then another sample is placed to make the scale stable.
		5	Output once when the scale is stable. Stop output when unstable. Output once when the scale is stabilized again (the output includes zero) even if it is not reloaded.
		6	Output once when the scale is stable. Output continuously when unstable. Output is stopped after a single output when the scale is stable even if it is not reloaded.
Baud Rate	5 2 b. L.	1	1200 bps
		2	2400 bps
		3	4800 bps
Parity Bit	5 3 P R.	0	Reserved (Not set.)
		1	Odd parity
		2	Even parity

* Shaded parts indicate factory default settings.

*1: In continuous output mode, data is output at intervals of 0.1 to 1 second. (The interval changes depending on the weighing conditions and settings of other functions.)

2 Checking the Set Value

1 Call the function.

Function Call

Press and hold.

Function Display

Release the finger.

The first function is displayed.

Press and hold the  key for approximately 4 seconds. When “Func” is displayed, release the finger.

Now the function setting mode is assumed and the first function “1SEL 0” (Function Selection) is displayed.

⇒ For details, refer to pages 26 and 27.

2 Select a function.

Function Selection

Stability Judgment function

Autozero function

Response Speed function

Press the  key, and the next function is displayed.

The next function is displayed each time the key is pressed.

⇒ For details, refer to pages 26 and 27.

3 Setting is over.

Setting is over.

Save the setting.

Weight display mode is resumed.

Press the  key, and the setting is saved and “PUSH S.” is displayed.

Press the  key again, and the setting process is terminated and the weight display mode is resumed.

3 Change the Setting

1 Call the function.

Function Call: 0.0 g

Function Display: Func

Press and hold.

Release the finger.

The first function is displayed.

1.5EL. 0

Press and hold the  key for approximately 4 seconds. When “Func” is displayed, release the finger.

Now the function setting mode is assumed and the first function “1.5EL. 0” (Function Selection) is displayed.

⇒ For details, refer to pages 26 and 27.

2 Select a function.

Function Selection: 1.5EL. 0

Autozero function: 2. RD 1

Stability Judgment function: 4. Sd 2

Response Speed function: 3. rE. 3

Press the  key, and the next function is displayed.

The next function is displayed each time the  key is pressed. Select the function whose setting you want to change.

⇒ For details, refer to pages 26 and 27.

3 Change a setting.

Display the current setting: 4. Sd 2

Display the desired setting: 4. Sd 3

Press the  key, and the rightmost value changes. Then select the value that you want to set.

4 Setting is over.

Setting is over: 4. Sd 3

Save the setting: PUSH 5

Weight display mode is resumed: 0.0 g

Press the  key, and the setting is saved and “PUSH 5” is displayed.

Press the  key again, and the setting process is terminated and the weight display mode is resumed.

Calibration of the Scale

The electronic scale is always influenced by gravity (G). The gravity changes depending on the geographical position and altitude above sea level, so the scale must be calibrated where it is installed. Calibration is also needed when an extended period of time has elapsed after installation or correct readings cannot be given.

The process of calibrating a scale is referred to as span adjustment.

1 Call the Span Adjustment function.

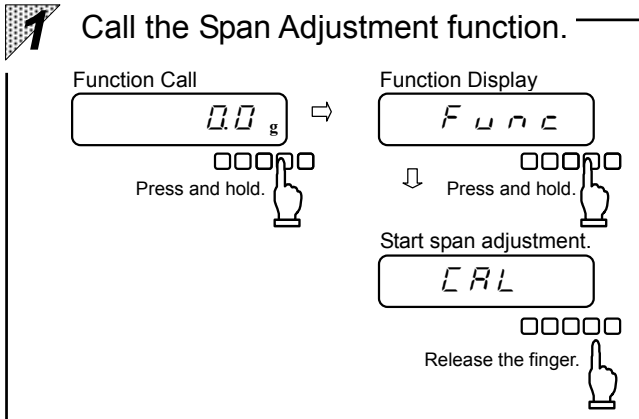

Function Call: 0.0 g

Function Display: Func

Start span adjustment: CAL

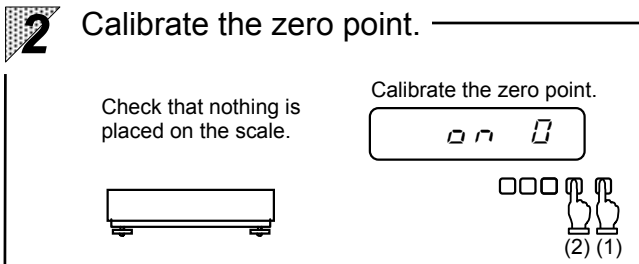

Press and hold the  key until the display changes from "Func" to "CAL." (This will take approximately 6 seconds.)

2 Calibrate the zero point.



Check that nothing is placed on the scale.

Calibrate the zero point: 0.0

Check that nothing is placed on the pan. Press the  key while holding the  key down and then release the keys simultaneously. The display blinks and the zero point is calibrated.

3 Setting of the zero point is over.

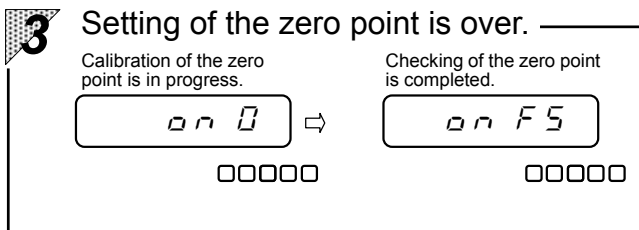

Calibration of the zero point is in progress: 0.0

Checking of the zero point is completed: 0.0 FS

When calibration of the zero point is completed, the display changes automatically and the capacity point can now be calibrated.

4 Calibrate the capacity point.

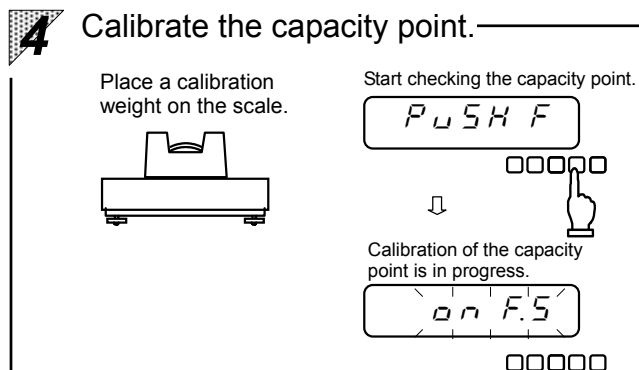



Place a calibration weight on the scale.

Start checking the capacity point: PUSH F

Calibration of the capacity point is in progress: 0.0 F.S

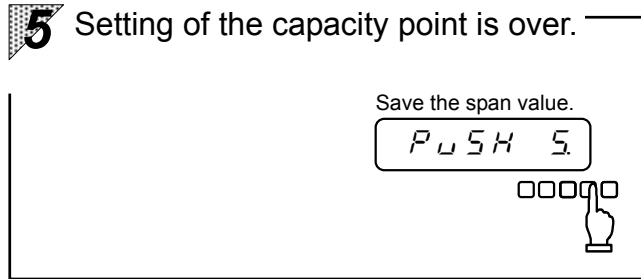
Gently place a calibration weight at the center of the pan. (When a medium- or large-sized scale is used, "PUSH F." is displayed at this time, so press the  key.) The display now blinks and the capacity point is calibrated.



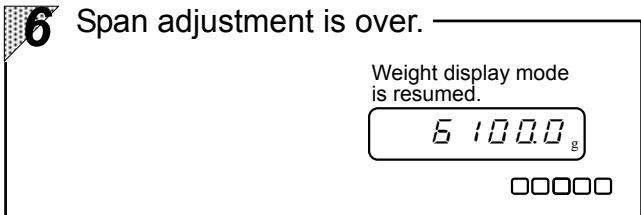

When calibration of capacity point is over, “PUSH S.” is displayed. Press the  key, and the span value is saved.











The weight display mode is resumed and span adjustment is completed.

Key points

1. If you press the  key first in step 2 where two keys should be pressed at a time, the process is discontinued.
2. Select calibration weights whose total weight is close to the weighing capacity.
(A span test can be performed by using calibration weights whose total weight is at least half the weighing capacity.)
3. Be careful that you do not touch the pan and that the scale is not influenced by wind or vibration during adjustment.
If the scale is influenced by wind or vibration, the display may stall at blinking of “0.0 0.”
4. If you want to discontinue the adjustment process, press the  key. The measurement mode is resumed.
5. Calibration of a scale is possible only when the lock switch is turned off.

Troubleshooting

Symptom	Cause	Action to take
The limit function does not work.	<ul style="list-style-type: none"> * The limit function is not selected. * A limit value is not entered. * The entered limit value is invalid. 	20P: Select the function. 24P: Perform the setting procedure. 24P: Check your operation.
The addition function does not work.	<ul style="list-style-type: none"> * The addition function is not selected. * The sum mode is assumed. 	17P: Select the function. 18P: Check your operation.
The display does not light.	<ul style="list-style-type: none"> * The power of the scale is turned off. ⊙ Erroneous connection of the power cable ○ The display was turned off by the autopower-off function. 	14P: Press the  key. 12P: Check the barrier connection. 25P: Press the  key.
The mark “  ” blinks.	<ul style="list-style-type: none"> ○ The battery power is weak. The mark blinks when the remaining time of the battery is about 6 hours. 	13P: Replace the batteries.
The display is slow to stabilize.	<ul style="list-style-type: none"> * The scale is affected by wind or vibration. * The pan, tare, or the sample touches other objects. * The table under the scale is unstable. 	7P: Check the environment of the location. Or review the setting of the function.
Errors in measurement values	<ul style="list-style-type: none"> * The taring operation is wrong. * The adjusters float, and the horizontal adjustment is not done correctly. * The displayed values changed after a long period of storage or when used in different locations. 	15P: Redo the taring. 11P: Check to make sure the scale is level. 30P: Calibrate the scale.
Weighing up to the weighing capacity is impossible.  - E r r is displayed.	<ul style="list-style-type: none"> * The weight with tare exceeds the weighing capacity. Weighable range = weight of the tare + weight of the sample If the tare has no problem: 	15P: Recheck the tare. →: Breakage of the mechanical section!!
 - E r r is displayed.	<ul style="list-style-type: none"> * The pan or the pan base is raised by other objects. If the pan and the pan base have no problem: 	16P: Check the surrounding conditions of the pan. →: Breakage of the mechanical section!!
 - E r r is displayed.	<ul style="list-style-type: none"> * The scale is affected by static electricity or noise. * The electrical section of the scale is broken. 	→: Failure of the electrical section
 - E r r is displayed.	<ul style="list-style-type: none"> * Addition was repeated twice. A negative number or zero was added. 	18P: Retry the addition.
 - E r r is displayed.	<ul style="list-style-type: none"> * If the standard weight is 40% of the weighing capacity or less (during adjustment or span tests by an external weight): 	30P: Retry span adjustment or span tests.
 - E r r is displayed.	<ul style="list-style-type: none"> * The scale is affected by wind or vibration during span adjustment. 	30P: Retry span adjustment.

<Meaning of symbols>

- *: Matters common to both types
- : Applies only to the dry-cell battery type.
- ⊙: Applies only to the power supply box type.

10P: The page to be referred to
 →: Contact the retailer or a sales office or service representative of our company.

Standard Specifications

1 Common Specifications

1. Explosion proof structure Exia II BT4
2. Precision class Class II
3. Measurement method Dielectric system (tuning fork system)
4. Taring range Up to weighing capacity
5. Display LCD of up to 7 digits (character height = 17 mm, character width = 9 mm, with a 5-degree slant)
6. Calibration of the Scale Semi-auto span adjustment
7. Display when overloaded “ $\square - E r r$ ” is displayed when the weighing capacity is exceeded by 9 divisions (over-error).
8. Operating temperature and humidity Temperature: +5 to +35°C, Humidity: 80%rh or less
9. Power supply Power supply box type: 230 VAC or 120VAC
Dry-cell battery type: C-size manganese dry-cell battery
(R14P(NR) National / Panasonic) ×6

10. Options

Printer output	For Shinko printers only
RS232C	D-sub 25 pin
RS422A	D-sub 25 pin
Limit output	12 pin terminals AC125 V, 0.4 A DC30 V, 2 A
Analog output	2 pin terminals DC5 V, 0.02 A
BCD output	36 pin terminals
<u>Remark:</u>	From above (1) through (4), two outputs are available to instal in one scale. However, the combination of RS232C and RS422A is unavailable.

11. Electrical Specifications

Power supply box specifications

Rating input voltage	AC230 V or AC120V
Rating input electric current	0.1 A
Frequency	50 Hz/60 Hz
Fuse specifications	
Rating input voltage	AC250 V
Rating input electric current	2 A
Type	Time lag

Please perform the exchange of the fuse after turning off power switch by all means.

Output terminal of the communication board (option ; Barrier type only)

2 Configuration of Each Model

2-1 Power Supply Box Type

Type	Model	Weighing capacity/minimum measurable weight	Dimension of pan	Empty weight	Length of scale cable
Small-sized model	GZ II-2000Ex	2000 g/0.01 g	φ170	Approx. 8 kg	1 m
	GZ II-6000Ex	6000 g/0.1 g	250 × 202	Approx. 9 kg	
	GZ II-12KEx	12000 g/0.1 g			
Medium-sized model	GZ II-30KEx	30000 g/1 g	360 × 326	Approx. 17 kg	2 m
	GZ II-60KEx	60000 g/1 g			

- * The weight of the power supply box is excluded from the empty weight. (Weight of the power supply box: approx. 3.5 kg)
- * The empty weight of the small model is the sum of the weights of the display section, measuring section, and pole.
- * The empty weight of the medium and large models is the sum of the weights of the display section and measuring section.

2-2 Dry-Cell Battery Type

Type	Model	Weighing capacity/minimum measurable weight	Dimension of pan	Empty weight	Length of scale cable
Small-sized model	GZ II-B2000Ex	2000 g/0.01 g	φ170	Approx. 9 kg	1 m
	GZ II-B6000Ex	6000 g/0.1 g	250 × 202	Approx. 10 kg	
	GZ II-B12KEx	12000 g/0.1 g			
Medium-sized model	GZ II-B30KEx	30000 g/1 g	360 × 326	Approx. 18 kg	2 m
	GZ II-B60KEx	60000 g/1 g			

- * The weight of the C-size manganese dry-cell batteries is included.
- * The empty weight of the small model is the sum of the weights of the display section, measuring section, and pole.
- * The empty weight of the medium and large models is the sum of the weights of the display section and measuring section.

SHINKO DENSHI CO., LTD.

HEAD OFFICE:

3-9-11 YUSHIMA, BUNKYO-KU, TOKYO 113-0034, JAPAN

TEL: 81-3-3835-4577 E-MAIL: shinko@vibra.co.jp

FAX: 81-3-5181-6066 URL: <http://www.vibra.co.jp/>

TSUKUBA PLANT:

4219-71 TAKASAI, SHIMOTSUMA, IBARAKI, 304-0031, JAPAN

TEL: 81-296-43-2001 FAX: 81-296-43-2130