

# Precision Tuning-Fork Platform Scale

## H J K Series

### Operation Manual

#### **IMPORTANT**

- To ensure safe and proper use of the scale, please read this manual carefully.
- After reading this manual, store it in a safe place near the scale, so you can review it as needed.

SHINKO DENSHI CO., LTD.



# Preface

---

Thank you very much for having purchased Precision Tuning Fork Platform Scale HJK series. This document describes how to operate the product.

## Instructions

- The copyright of this document belongs to SHINKO DENSHI CO., LTD.. Reprinting or duplicating of all or part of this document without notice shall not be allowed.
- Please note that product improvement or modification may cause partial discrepancy between the product and the description of this document.
- The description of this document is subject to change without notice.
- This document has been created carefully. In case that, however, any error or imperfection is found by any chance, please let us know.
- Documents of which pages are missing or irregularly bound will be exchanged. Please inform the store where you purchased the product.
- Trouble related to the product or system will be dealt with in accordance with the individual maintenance contract. Please note, however, that we will not take responsibility for consequential trouble such as discontinuation of operation caused by the product trouble.
- **VIBRA** is the registered trademark of SHINKO DENSHI CO., LTD.. Company names and product names appearing in this document are the trademarks or registered trademarks of the respective company concerned.

# Important Notice

---











- It should be known that this product contains potential danger. And so please be sure to observe this document when installing, operating or servicing this product.
- SHINKO DENSHI CO., LTD. will not take any responsibility for any injury or damage caused by the non-observance of this document or misuse or unauthorized modification of this product.

- Potential dangers are increasing in the industrial equipment industries due to the advent of new materials, new processing methods and speeding up of machines. It is impossible to foresee all situations related to these dangers. In addition, there are so many “impossible” and “don’ts” and so writing all of them in the operation manual is impossible. Therefore, it is safe to think that what is not written in the operation manual “cannot be performed” unless the operation manual positively writes “it is possible.” When performing installation, operation, maintenance or inspection of this product, not only observe what is written or indicated in this document or on the product surface but also pay adequate consideration to safety measures.
- For any question or further information concerning this document, please contact the store where you purchased the product with its model (type) name and serial number informed.
- Manufacturer: SHINKO DENSHI CO., LTD.  
Address: 3-9-11 Yushima, Bunkyo-ku, Tokyo 113-0034 JAPAN

# How to use this document

## ■ Symbols used in this document

Understand the meaning of the following symbols and observe the instructions of this document.

Symbols	Meaning
	Used for high risk point concerning the operations that may lead to death or severe physical injury to persons if proper precautions are not taken.
	Used for warning concerning the operations that may lead to death or severe physical injury to persons, if proper precautions are not taken.
	Used for caution concerning operations that may lead to a light physical injury to persons if proper precautions are not taken.
	Used for notation concerning operations that may lead to damage of the products/facilities/data if proper precautions are not taken. Used for accurate weighing and appropriate usage of the equipment.
	Used for referenced information which is useful for product operation.
	Used for "Prohibition" items
	Used for "Mandatory" items requiring positive action
	Used for prohibition items to avoid "Electrical shock".
	This symbol indicates the operation/specification in related to the verified scale for legal metrology.

This product/ The product/The scale	Refers to the product.
[KEY NAME] key	The name of an operation key located on the indicator unit is represented in square brackets "[ ]".
<MESSAGE>	A message on the display is represented in angle brackets "< >".
<<ITEM>>	Displayed menu item assigned to each functional key is represented in double angle brackets "<< >>".
Press the key	Signifies pressing lightly an operation key once.
Press the key long	Signifies keeping pressing an operation key until the designated indication/operation occurs.

# Contents

---

Preface.....	i
Important Notice.....	ii
How to use this document.....	iii
Contents.....	iv
<b>1 Prior to use.....</b>	<b>1</b>
1-1 Operating precautions .....	1
1-2 For more accurate measurement .....	3
1-2-1 Precautions related to measuring environment .....	3
1-2-2 Precautions related to measuring table .....	3
1-2-3 Precautions related to a specimen.....	4
1-2-4 Precautions related to the main unit of a scale .....	4
1-3 Check for the articles contained in the box .....	5
1-4 Name of each section.....	6
1-5 Assembling and installation of the product.....	7
1-5-1(1) Procedure for installing the separate type scale without integrating the indicator unit .	7
1-5-1(2) Procedure for installing the separate type scale with integrating the indicator unit .....	8
1-5-2 Procedure for connection with AC adapter and peripherals.....	10
1-5-3 Level.....	11
1-6 How to carry the scale.....	12
1-7 Description of the operation keys .....	13
1-7-1 Basic.....	13
1-7-2 Setting value and numeric value inputting .....	14
1-8 How to interpret the display.....	15
1-8-1 Description of segment .....	15
1-8-2 LCD character font.....	16
<b>2 Basic usage.....</b>	<b>17</b>
2-1 Turning on/off the power, and checking for the operation .....	17
2-2 Zero-point adjustment .....	17
2-3 Weighing samples with container (tare) .....	18
2-4 Weighing the additional sample .....	19
2-5 Basic operation.....	19
2-5-1 Hierarchy of a setting menu .....	19
2-5-2 Operation of the setting menu.....	20
2-5-3 Numeric value input .....	21
2-5-4 Functional keys switching at each measuring mode.....	22
<b>3 Functions related to the operation.....</b>	<b>23</b>
3-1 Hierarchy of functions related to the operation .....	23
3-2 Various measuring modes of the scale .....	25
3-2-1 Weighing mode .....	25
3-2-2 Counting mode.....	25
3-2-2 (1) Actual value setting method .....	26
3-2-2 (2) Numeric value setting method.....	28
3-2-2 (3) Switching the display at Counting mode .....	28
3-3 Percentage mode .....	29
3-3-1 Switching the display at percentage mode .....	30
3-4 Multiplied by Coefficient mode .....	31
3-4-1 Switching the display at Multiplied by Coefficient .....	32
3-5 Unit setting .....	32
3-6 Comparator function.....	33
3-6-1 How to perform discrimination.....	33
3-6-2 Comparator function setting.....	34
3-7 Adding function.....	35

3-7-1	Weighing by means of addition .....	36
3-8	Stabilization wait setting .....	37
3-9	Bar graph indication .....	37
3-10	Backlight setting .....	37
3-11	Auto power-off .....	38
3-12	Buzzer setting.....	38
3-13	“Simple SCS(Self Counting System) method” setting.....	39
3-14	Range mode setting .....	39
<b>4</b>	<b>Functions related to the performance .....</b>	<b>40</b>
4-1	Hierarchy of functions related to the performance .....	40
4-2	Stability discrimination width .....	40
4-3	Response speed .....	41
4-4	Zero tracking .....	41
<b>5</b>	<b>Preset tare and Comparator setting.....</b>	<b>42</b>
5-1	Hierarchy of Preset tare and Comparator setting.....	42
5-2	Preset tare .....	43
5-2-1	Preset tare setting.....	43
5-2-2	Inputting of a preset tare weight value .....	43
5-2-2 (1)	Actual value setting method .....	44
5-2-2 (2)	Numeric value setting method.....	44
5-2-2 (3)	Exiting the preset tare mode .....	44
5-3	Setting of the discrimination value of the comparator function.....	45
5-3-1	Actual value setting method .....	46
5-3-2	Numeric value setting method.....	46
<b>6</b>	<b>External input/output functions .....</b>	<b>47</b>
6-1	Hierarchy of the external input / output functions .....	47
6-2	Connector terminal numbers, their functions and specifications.....	48
6-2-1	D-SUB9P Connector for RS232C I/O .....	48
6-2-2	D-SUB9P Connector for serial output for peripherals .....	49
6-3	Communication format .....	49
6-3-1	Basic data output format / CSP format.....	49
6-3-2	CBM data output format .....	51
6-4	Input command.....	52
6-4-1	Transmission procedure.....	52
6-4-2	Input command composition 1 .....	53
6-4-2 (1)	Zero-point adjustment/Tare/Output control setting command .....	53
6-4-2 (2)	Date output request and time output request.....	53
6-4-2 (3)	Span adjustment/test command.....	54
6-4-3	Input command composition 2 .....	54
6-4-3 (1)	Comparator setting command .....	54
6-4-3 (2)	Preset tare value setting command.....	54
6-4-3 (3)	Interval (output) time setting command .....	54
6-5	Response .....	55
6-5-1	Response command format (A00/Exx format).....	55
6-5-1(1)	Response command .....	55
6-5-2	Response command format (ACK/NAK format) .....	55
6-5-2(1)	Response command .....	55
6-6	Communication setting.....	55
<b>7</b>	<b>Functions related to the lock.....</b>	<b>57</b>
7-1	Hierarchy of functions related to the lock .....	57
7-2	Total lock release.....	57
7-3	Key lock function .....	58
7-4	Menu lock function .....	58
<b>8</b>	<b>Controlling and adjustment functions.....</b>	<b>59</b>
8-1	Hierarchy of controlling and adjustment functions .....	59



8-2	Shortcut setting for accessing various measuring modes .....	61
8-3	Free key setting .....	62
8-4	Adjustment and test .....	63
8-4-1	Span adjustment and span test .....	63
8-4-1(1)	Span adjustment with external weight .....	63
8-4-1(2)	Span test with external weight .....	65
8-4-1(3)	Semi-Automatic Span adjustment with internal weight .....	66
8-4-1(4)	Span test with internal weight .....	66
8-4-2	Calibrating the internal weight .....	67
8-4-3	Restore the internal weight calibration value to default .....	69
8-4-4	Advice CAL .....	69
8-5	Scale control setting .....	70
8-5-1	Scale ID setting .....	70
8-5-2	Password control .....	70
8-5-2 (1)	Administrator password registration .....	71
8-5-2 (2)	User password registration .....	71
8-5-3	Outputting of the span adjustment / test result .....	72
8-5-4	Date indication format .....	72
8-5-5	Date setting .....	72
8-5-6	Time setting .....	73
8-5-7	Output language .....	73
8-5-8	Readability Setting .....	74
8-5-9	Span adjustment with internal weight at power-on .....	74
8-5-10	Direct start setting .....	75
8-5-11	Save tare weight function .....	75
8-5-12	Initialise .....	76
<b>9</b>	<b>Troubleshooting .....</b>	<b>77</b>
9-1	Error message .....	77
<b>10</b>	<b>How to clean the scale .....</b>	<b>79</b>
<b>Appendix</b>	<b>.....</b>	<b>80</b>
Appendix 1	Specifications .....	80
Appendix 1-1	Basic Specifications .....	80
Appendix 1-2	Functional specifications .....	82
Appendix 2	Dimensional outline drawing .....	84
Appendix 3	Unit conversion table .....	85
Appendix 4	Weighing capacity and readability by non-metric units .....	86
Appendix 5	Scale operation with password control function .....	87
Appendix 5-1	User's authority setting .....	87
Appendix 5-2	User/guest login .....	88
Appendix 6	Operation with internal rechargeable battery .....	89
Appendix 6-1	Specifications of battery .....	89
Appendix 6-2	Recharging battery .....	89





# 1 Prior to use

## 1-1 Operating precautions

### DANGER

	<p>■ <b>Do not wet the AC adapter.</b> That may cause an electric shock, short-circuiting or failure.</p>
	<p>■ <b>Do not expose the AC adapter to dust.</b> That may cause an electric shock, short-circuiting or failure.</p>
	<p>■ <b>Do not handle the AC adapter with wet hands.</b> That may cause an electric shock, short-circuiting or failure.</p>
	<p>■ <b>Do not use the scale in a dust-filled room.</b> That may cause dust explosion or fire.</p>
	<p>■ <b>Do not use the scale in explosive atmosphere.</b> That may cause explosion or fire. Please order our explosive-proof scales to weigh in such a hazardous area.</p>
	<p>■ <b>Obey the MSDS.</b> Measuring dangerous materials such as flammable liquid could cause an explosion or fire.</p>



### WARNING

	<p>■ <b>Do not disassemble or modify the product.</b> Doing so could result in injury, electric shock, fire and other accidents or failures. For inspection and adjustment, contact the retailer from whom the product was purchased.</p>
	<p>■ <b>Do not move the product with a sample to be weighed set on the scale.</b> That may cause the sample to fall from the weighing pan, leading to a bodily injury or destruction of the sample.</p>
	<p>■ <b>Do not route the cables across passages.</b> The cables could be tripped on by a passed by and the scale could fall down and break or injure someone.</p>
	<p>■ <b>Do not use the product on an unstable table or a place that is subject to vibration.</b> That may cause the sample to fall from the weighing pan, leading to a bodily injury or destruction of the sample. Besides inaccurate weighing may result.</p>
	<p>■ <b>Do not place an unstable sample on the weighing pan.</b> The sample may fall down, giving rise to a danger. Put an unstable sample in a container (tare) before weighing it.</p>
	<p>■ <b>Do not use the product in an abnormal condition.</b> If it should happen that an abnormal event such as smoking or unusual odor occurs, ask the store where you purchased the product or our sales department for repair. Keeping using the product may result in an electric shock or fire. In addition, do not ever try to repair it for yourself, or very dangerous situation is likely to occur.</p>
	<p>■ <b>Only use the dedicated AC adapter.</b> Use of other types of power or adapters may result in heat generation or malfunction of the scale.</p>

 **CAUTION**

	<p>■ <b>Do not use the indicator unit in a wet/dusty location when AC adapter jack cover or D-sub 9p connector covers are opened.</b> That may cause an electric shock, short-circuiting or failure.</p>
	<p>■ <b>Do not connect to the AC adapter cord or communication cable with its connector or jack being wet.</b> That may cause an electric shock, short-circuiting or failure.</p>

**Note**

	<p>■ <b>Do not install the scale in a place where it is directly exposed to airflow from air-conditioning or heating equipment.</b> Due to changes in the ambient temperature, the scale could fail to accurately weigh samples.</p>
	<p>■ <b>Do not install the scale in a place exposed to direct sunlight.</b> The internal temperature of the scale could rise, and the scale could fail to accurately weigh samples.</p>
	<p>■ <b>Do not install the scale where the floor is soft.</b> When a sample is placed on the scale, the scale could slant and fail to accurately weigh samples.</p>
	<p>■ <b>Do not install the scale in a place where the ambient temperature or humidity change significantly.</b> The scale could fail to accurately weigh samples.</p>
	<p>■ <b>Do not apply excessive force to or impact the scale.</b> Doing so could damage or result in failure of the scale. Carefully place samples on the scale.</p>
	<p>■ <b>Do not use volatile solvents for cleaning anything other than the weighing pan.</b> The key panel, dust/waterproof packing or other resin components could deform, and the scale no longer maintains the dust/waterproofness. Wipe each unit using dry cloth or a cloth moistened with a small amount of neutral detergent.</p>
	<p>■ <b>Adjust (calibrate) the scale when it is installed or relocated.</b> Failure to do so might result in measurement errors. To ensure accurate measurements be sure to adjust (calibrate) the scale.</p>
	<p>■ <b>Check for an error periodically.</b> Use environment and chronological change cause an error in measured value, leading to an inaccurate measurement.</p>
	<p>■ <b>Unplug the AC adapter from the receptacle when the scale is not going to be used for a long period of time.</b> Unplug the scale from the receptacle to save energy and prevent degradation.</p>
	<p>■ <b>Always adjust the level of the scale before use.</b> A tilted scale generates errors which might cause inaccurate weighting.</p>
	<p>■ <b>For proper disposal</b> This product including accessories may not be disposed of in domestic waste in conformance with the specific requirements in your country, such as the European Directive 2012/19/EU on waste electrical and electronic equipment (WEEE). When you dispose of this product, please contact your local authorities or dealer and ask for the correct method of disposal.</p>

## 1-2 For more accurate measurement

To make more accurate measurement, it is necessary to lessen error-causing factors in measurement to the extent possible. Error-causing factors include not only an instrument error and performance of the scale itself but also the nature and condition of a specimen, measuring environment (vibration, temperature, humidity, etc.) and the like. These factors will directly affect measurement result in the case of a scale with high resolution capability.

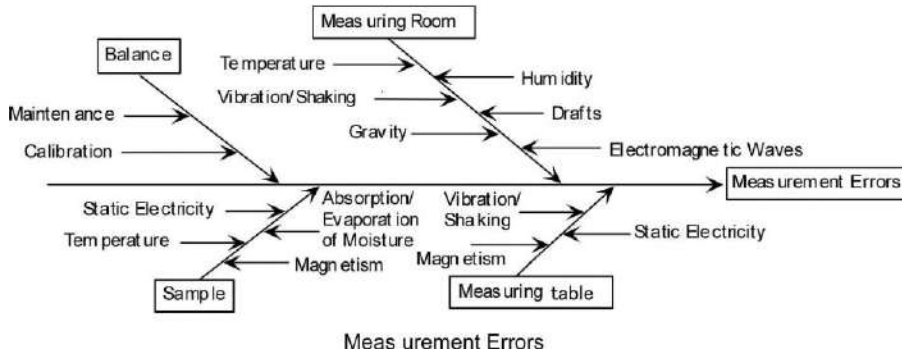

### 1-2-1 Precautions related to measuring environment

Temperature/ humidity/ atmospheric pressure	<ul style="list-style-type: none"> <li>→ Try to keep the room temperature constant to the extent possible in order to avoid condensation and indication drift due to change in temperature.</li> <li>→ Low humidity is likely to cause generation of static electricity, resulting in inaccurate measurement.</li> <li>→ Change of atmospheric pressure is likely to cause change of buoyancy of the air on the specimen, tare and mechanism of the scale, resulting in inaccurate measurement.</li> </ul>
Vibration/shaking	→ It is preferable to locate a measuring room on the first floor or the basement. The higher the room is, the larger the vibration and shaking become. Therefore, a highly located room is not suitable for measurement. Rooms near the railway or road side should also be avoided.
Air draft	→ Places directly exposed to air current from an air-conditioner or to direct sun generate abrupt temperature change and resultantly cause unstable weight indication, and therefore, should be avoided.
Gravity	→ The latitude and altitude of a measuring location differentiate the gravity that affects a specimen, giving a different weight indication to the same specimen.
Electromagnetic wave	→ At a location where a strong electromagnetic wave generating object is in the proximity of a scale, the scale is affected by the electromagnetic wave, making the scale unable to indicate accurate weight, and therefore, such a location should be avoided.

### 1-2-2 Precautions related to measuring table

Vibration/shaking	<ul style="list-style-type: none"> <li>→ Vibrations during measurement destabilizes the indication of measurement value, leading to inability to make accurate measurement. And so use of a measurement table that is robust and hardly affected by vibration is required (a vibration-proof structured table or concrete or stone-made table is suitable). In addition, placing a sheet of soft cloth or paper under the scale causes shaking or makes keeping horizontal attitude difficult, and therefore should be avoided.</li> <li>→ The measurement table should be installed in a position free from vibration to the extent possible. A corner rather than the centre of a room is less affected by vibration and therefore more suitable for installation of the scale.</li> </ul>
Magnetism/Static electricity	→ Use of the scale on the table that is subject to magnetism or static electricity should be avoided.

### 1-2-3 Precautions related to a specimen

Static electricity	→ In general, synthetic resin- and glass-made specimens are high in electric insulation, and so easily charged electrically. Weighing an electrically charged specimen makes the indication value unstable, reducing the reproducibility of the test result. Therefore, neutralize an electrically charged specimen before measurement.
Magnetism	→ Specimens affected by magnetism show different weight in a different position of the weighing pan, reducing the reproducibility. When weighing a magnetized specimen, either eliminate the magnetism from the specimen or place a setting plate on the weighing pan to distance the specimen from the weighing mechanism of the scale so that the mechanism may not be affected by the magnetism.
Moisture absorption/ Evaporation	→ Measuring a moist or evaporating (vaporizing) specimen increases or decreases the indication value of the scale continuously. When this is the case, put the specimen in a container equipped with a small mouth and closely seal the mouth before measurement.

### 1-2-4 Precautions related to the main unit of a scale

Operating precautions	→ A dust cover, if equipped, for the scale may possibly make the weight indication unstable due to static electricity charged on the cover at a low humidity. When this is the case, wipe the cover with wet cloth or use antistatic agent or use the scale with the cover removed. → For more stable measurement, it is recommended to energize the scale for longer than 30 minutes and load the scale a few times with a weight equivalent to the weighing capacity before measurement.
Adjustment	→ Calibrate the scale periodically with an external adjustment weight or internal adjustment weight. For the sake of precise calibration, use an external adjustment weight weighing nearly equal to the weighing capacity of the scale. → Energize the scale for longer than 30 minutes and load the scale a few times with a weight equivalent to the weighing capacity before adjustment. → Adjustment is also needed in the following cases: When using the scale for the first time, When using the scale after a long period of non-use, When changing a place of installation, and When there was a large change in temperature, humidity or atmospheric pressure.
Maintenance	→ Attachment of dirt such as powder or liquid to the weighing pan or pan base will cause measurement error or unstable weight indication. For that reason, frequent cleaning of the scale is required.

### 1-3 Check for the articles contained in the box

The package box contains the following;

If anything missing or broken should be found, please inform the store where you purchased the product.

① Weighing unit and indicator set: 1

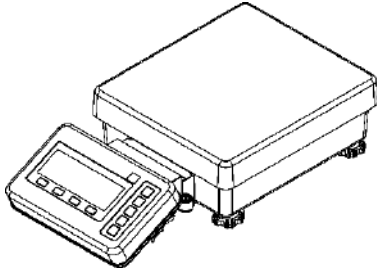

② Cable cover: 1

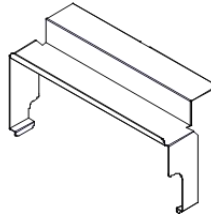

③ Base cover: 1

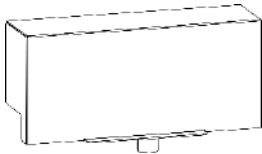

④ Indicator mounting bracket: 1

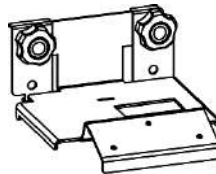

⑤ AC adapter: 1

AC adapter plug set: 1

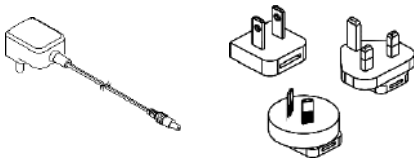

⑥ Operation manual: 1

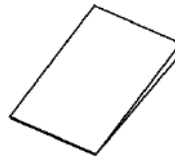

## 1-4 Name of each section

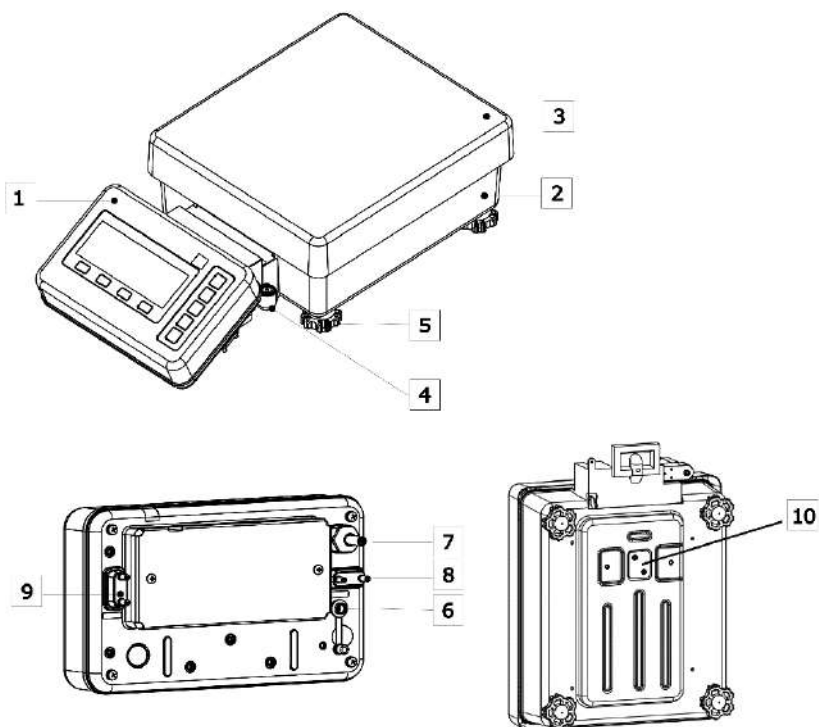

1	Indicator unit	2	Weighing unit
3	Weighing Pan	4	Level
5	Adjusters (Adjustable legs)	6	AC adapter jack * Mount the connector cover when not connected.
7	Scale cable (Unremovable)	8	RS-232C connector (D-sub 9 pin male) * Mount the connector cover when not connected.
9	Connector for peripheral devices (D-sub 9 pin male) * Mount the connector cover when not connected.	10	Cover of hanging hook (The hook for hanging is an option. For more information, refer to the instruction manual for the hook for hanging.) * Close the cover to protect against dust and water when not in use.

## 1-5 Assembling and installation of the product

### 1-5-1(1) Procedure for installing the separate type scale without integrating the indicator unit

- 1** Remove the weighing pan of the weighing unit.

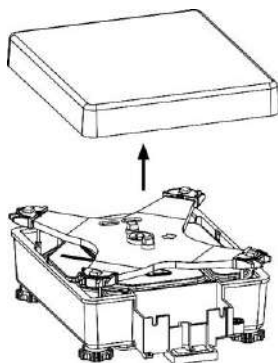

- 2** Slightly open both sides of the cable cover and mount it vertically in the cable housing. Then mount the base cover in the front of the cable housing so that it is hooked on the cable cover.

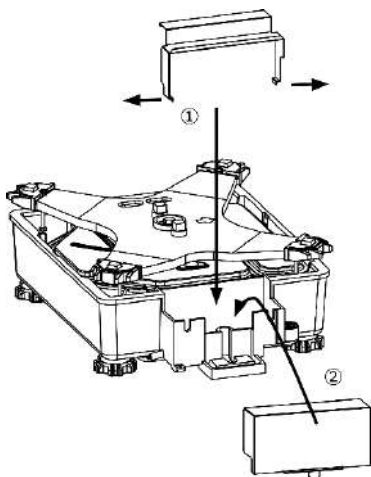

- 3** Put back the weighing pan.

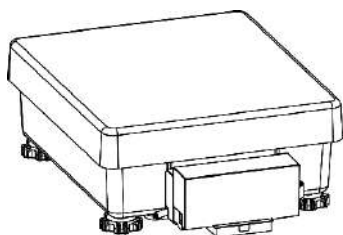

**1-5-1(2) Procedure for installing the separate type scale with integrating the indicator unit**

- 1** Remove the weighing pan of the weighing unit.

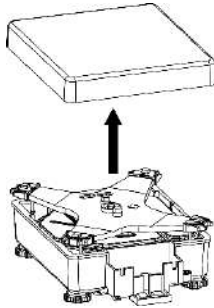

- 2** Loosen the two knobs in the indicator mounting bracket and mount it vertically in the cable housing.  
Check that the supporting boards are hooked on the bottom of the cable housing.  
Then fasten the knobs.



- 3** Fold the cable and put it in the cable housing with 15 cm of the cable left unfolded in the indicator-unit's end.

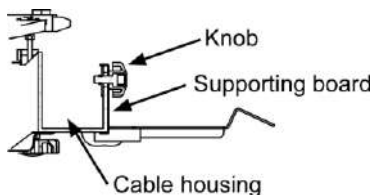

- 4** Slightly open both sides of the cable cover and mount it vertically in the cable housing.

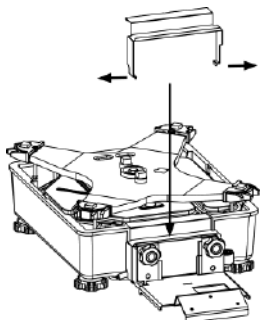



**5** Put back the weighing pan.

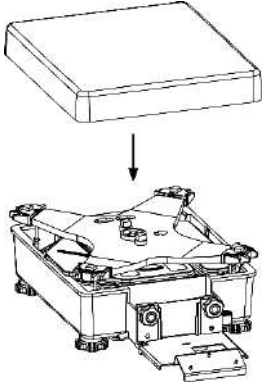

**6** Then insert the indicator unit in the indicator mounting bracket at an angle.

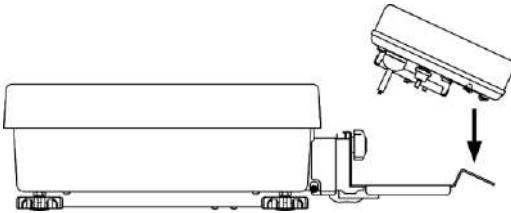

**7** Mount the base cover vertically.

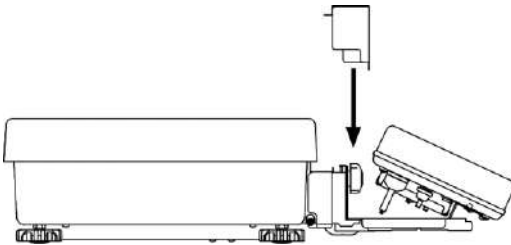

## 1-5-2 Procedure for connection with AC adapter and peripherals



- (1) Be sure the AC adapter jack and Dsub-9p connectors not being wet.
- (2) When not connected, be sure not leave covers of the AC adapter jack and Dsub-9P connectors open.

- 1** Remove the covers for D-sub 9P connectors and connect RS232C cables when necessary

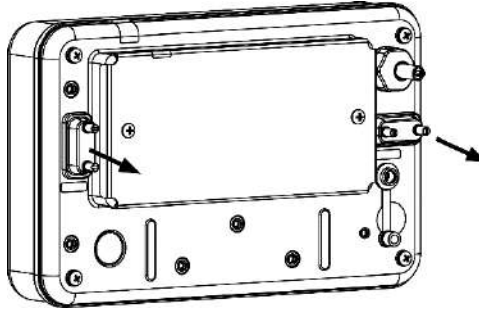

- 2** Put the AC adapter plug to the AC adapter, remove the cap of AC adapter jack.

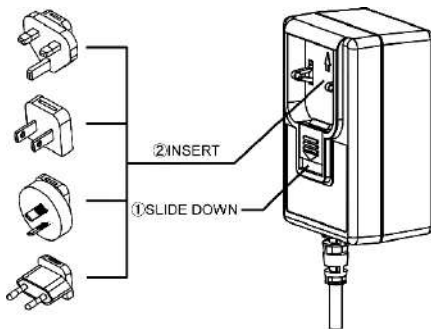

- 3** Remove the cover for AC adapter jack and connect AC adapter.

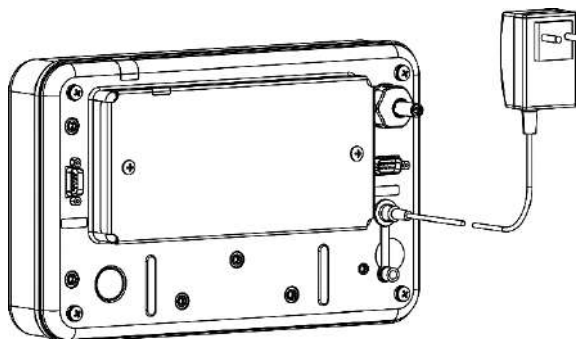

## 1-5-3 Level

### 1 Release the transportation lock of the adjuster.

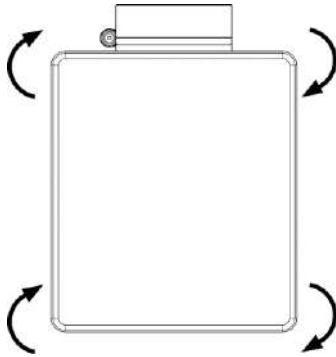

At the time of shipment, the adjusters provided at the four corners of the bottom are locked. Turn them in the direction shown in the figure on the left to loosen them.

### 2 Level the scale.

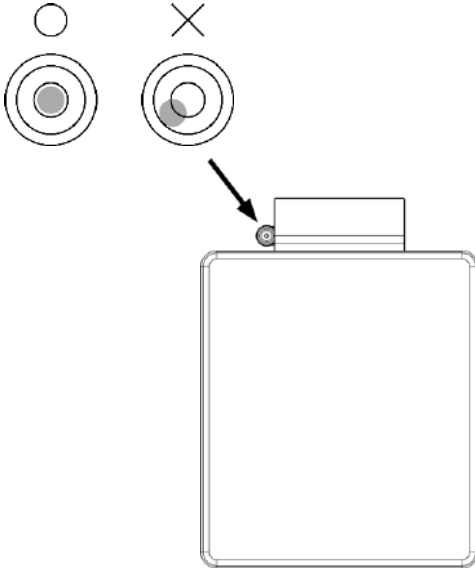

- (1) While watching the level, turn the adjusters provided on the bottom to level the main unit.
- (2) Bring the bubble enters in the centre circle as shown in the figure on the left.
- (3) When having levelled the main unit, slightly push the four corners of the scale to make sure that there is no rattle.

## 1-6 How to carry the scale



- (1) Make sure not to carry the scale with the cable hanging.
- (2) Make sure not to carry the scale with weighing object on the weighing pan.
- (3) Wearing the safety shoes and work gloves is highly recommended.

### Note

Be careful not to apply excessive force to or impact the scale.

This product is heavy and should be carried according to the following manual.

1. Unplug AC adapter and interface cables.
2. When the separate type, bundle the scale cable not to hang on the floor.
3. Holding position to lift up and carry: Bottom surface of the scale. Do not grab the weighing pan or indicator unit.

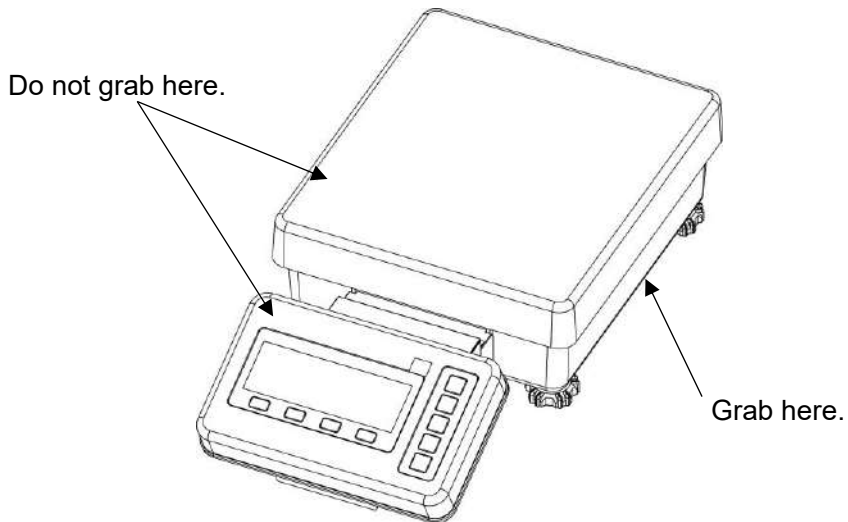

4. Using a hand truck trolley is highly recommended. When using it, lay cushioning material on it to prevent impact to the scale.

## 1-7 Description of the operation keys

### 1-7-1 Basic

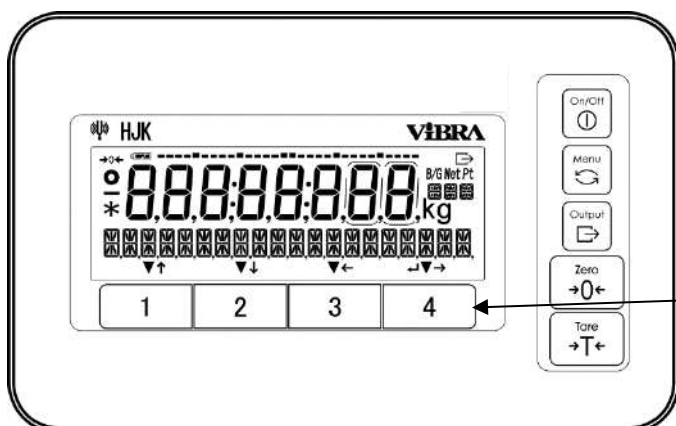

#### Reference

These keys are collectively called “functional keys” in this manual as a matter of convenience.

No	Key	Name of key	Performance
1		[On/Off]	Turns on and off the power for the scale. On: Press the key, Off: Press the key long
2		[Menu]	Used for calling/exiting the setting menu. Used for cancelling the setting value selection and going back to the measuring mode.
3		[Output]	Use for data outputting.
4		[Zero]	Use for zero-point adjustment.
5		[Tare]	Use for tare subtraction.
6		[1]	< ▼ > : Use for selecting the mode, function and item. < ↑ > : Use for moving up to the menu/item selections, or use for incrementing the numeric values.
7		[2]	< ▼ > : Use for selecting the mode, function and item. < ↓ > : Use for moving down to the menu/item selections, or use for decrementing the numeric value.
8		[3]	< ▼ > : Use for selecting the mode, function and item. < ← > : Use for moving to the upper menu layer, or use for selecting the digit to change.
9		[4]	< ▼ > : Use for selecting the mode, function and item. < → > : Use for moving to the lower menu layer, or use for selecting the digit to change. < ↵ > : Use for entering/executing the selected menu/item/value, or use for returning to the setting menu/measuring mode.

#### Reference

The functional keys on which < ↑ >, < ↓ >, < → >, < ← >, < ↵ > or < ▼ > are displayed above are valid.

Shortcuts for various modes/functions can be assigned to each functional key. Please refer to “8-2 Shortcut setting for accessing various measuring modes” and “8-3 Free key setting”.

## 1-7-2 Setting value and numeric value inputting

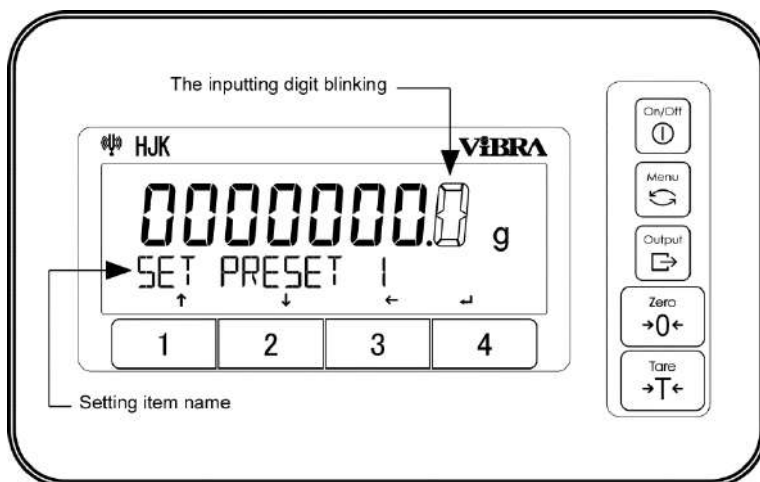

No	Key	Name of key	Performance
1		[Menu]	Cancel the input value and go back to the setting menu.
2		[Zero]	Use for changing polarity <+/->.
3		[Tare]	Input a decimal point <. > in the "Multiplied by Coefficient mode"
4		[1]	< ↑ > : Use for incrementing the numeric values. <0 → 1 → 2 → ... → 9 → 0>
5		[2]	< ↓ > : Use for decrementing the numeric values. <0 → 9 → 8 → ... → 1 → 0>
6		[3]	< ← > : Use for selecting the digit to change.
7		[4]	< ↵ > : Use for entering the value.

### Reference

The functional keys on which < ↑ >, < ↓ >, < → >, < ← >, < ↵ > or < ▼ > are displayed above are available.

## 1-8 How to interpret the display

### 1-8-1 Description of segment

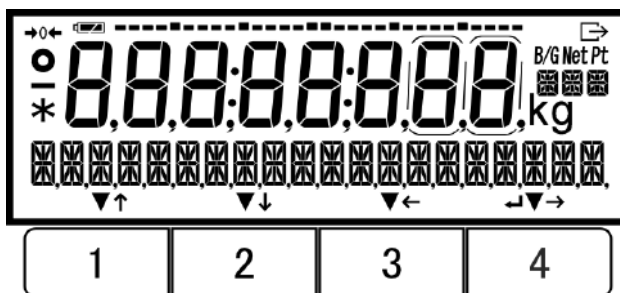

No	Mark	Name	Description
1	—	Minus	Indicates the negative weight value and numeric.
2	○	Stable mark	- When displayed: The scale is in the stable condition. - When not displayed: The scale is not in the stable condition.
3	→0←	Zero point	Indicates the zero point.
4	8	7-segment	- Indicates the weight value - Indicates the simplified character.
5	🔋	Battery mark	Display when the scale is powered by batteries.
6	👉	Output	Displayed when data are being output to external devices.
7	B/G	Gross weight	Indicates gross weight.
8	Net	Net weight	- Indicates that the tare weight is being subtracted. - Indicates the preset tare weight is being subtracted.
9	Pt	Preset tared weight	Indicates the preset tare weight is being subtracted.
10	g	gram	Indicates the gram unit.
11	kg	kilogram	Indicates the kilogram unit.
12	📄📄📄	16-segment message 16-segment unit	- Displays various messages. - Indicates the various units.
13	↑ ↓ → ← ↙ ▼	Operation of the functional key	Displayed when the functional keys are effective.
14	:	Colon	Displayed when the date and time display.
15	*	Asterisk	- Lights in the standby status. - Indicates addition available status when the adding function is used.
16	-----	Bar graph	- Indicates the present total amount relative to the weighing capacity defined as 100%. - Indicates the state of span adjustment / calibration with internal weight.
17	□	Auxiliary scale interval	Lights up only when the auxiliary scale interval is displayed.

## 1-8-2 LCD character font

### ■7-segment

A	B	C	D	E	F	G	H	I	J	K	L	M	N	O
A	b	C	d	E	F	G	H	I	J	K	L	M	N	O
P	Q	R	S	T	U	V	W	X	Y	Z	c	comma	point	
P	Q	R	S	T	U	V	W	X	Y	Z	c	comma	point	
1	2	3	4	5	6	7	8	9	0	space	minus / hyphen			
1	2	3	4	5	6	7	8	9	0	space	minus / hyphen			

### ■16-segment

A	B	C	D	E	F	G	H	I	J	K	L	M	N	O
A	B	C	D	E	F	G	H	I	J	K	L	M	N	O
P	Q	R	S	T	U	V	W	X	Y	Z				
P	Q	R	S	T	U	V	W	X	Y	Z				
b	c	d	g	l	m	n	o	t	w					
b	c	d	g	l	m	n	o	t	w					
1	2	3	4	5	6	7	8	9	0					
1	2	3	4	5	6	7	8	9	0					
asterisk	slash	left arrow	right arrow	space	plus	minus / hyphen								
*	/	←	→		+	-								
comma	point	percent	Degree Celsius											
,	.	%	°C											



## 2 Basic usage

### 2-1 Turning on/off the power, and checking for the operation

**Note**

After the scale has been moved, allow it to adapt to the ambient temperature for stable measurement. In addition, allow five minutes after turning on the power for the scale to warm up.

#### 1 Turn on the power for the scale.

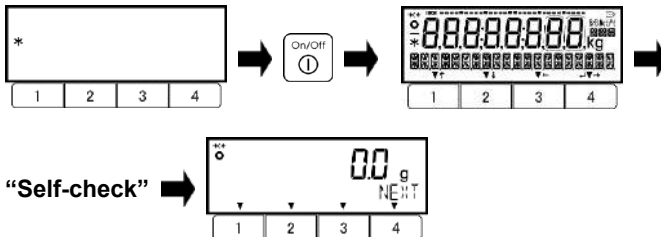

- Connect the included AC adapter to the scale.
- When the AC adapter is plugged in, the scale enters the standby state and an asterisk < \* > appears.
- Press [On/Off] key.
- All displays on the LCD lights, followed by the self-check of the scale. During the self-check, the LCD display automatically changes.
- Completion of the self-check is followed by the measuring mode.

**Note**

Do not press any key during the self-check.

#### 2 Scale operation check.

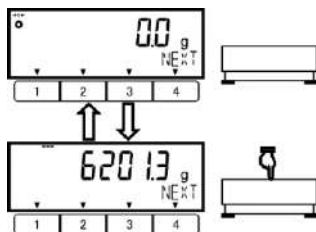

- Push the weighing pan lightly to check if the indication changes.

#### 3 Turn off the power for the scale.

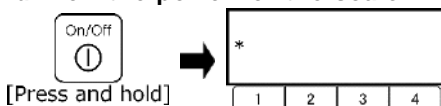

- Press and hold [On/Off] key (About 2 seconds)

- (1) Pressing and holding [ On/Off ] key obtains the standby status from any operation status.
- (2) The scale starts up in the last measuring mode before it was switched off.

**Reference**



Verified scale always starts up in weighing mode.

### 2-2 Zero-point adjustment

Adjusting the indication to zero is called "Zero-point adjustment".

#### 1 Check the weighing pan.

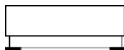

- Make sure that nothing is placed on the weighing pan.

#### 2 Execute "Zero-point adjustment".

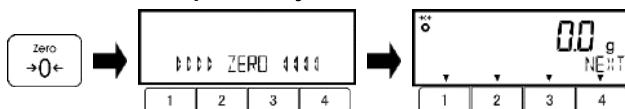

- Press [Zero] key.
- Indication becomes zero and the symbol " →0← " lights.

- (1) Zero-point adjustment cannot not be performed when a sample whose weight is over the "Zero-point adjustment range" (cf. Appendix 1-1 Basic specifications) is placed on the weighing pan. In that case, execute "tare subtraction" referring to the "2-3 Weighing a sample placed on a container (tare)"
- (2) Stability waiting during the Zero-point adjustment can be set using the Setting menu <17 WT STABLE>.

**Reference**



The setting of <17 WT STABLE> is not changeable and the scale always wait stability during the zero-point adjustment.

## 2-3 Weighing samples with container (tare)

When weighing samples placed on a container (tare), the weight of the container must be subtracted from the total weight to get the actual weight of the object to be weighed. This is called “tare subtraction” or “tare”.

### 1 Place a container on the weighing pan.

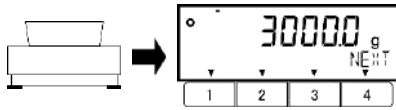

- Place a container on the weighing pan.

The weight of the container is displayed.

### 2 Perform tare subtraction.



- Press [Tare] key.

The indication changes to zero and the < Net > symbol lights.

### 3 Check the tare weight.

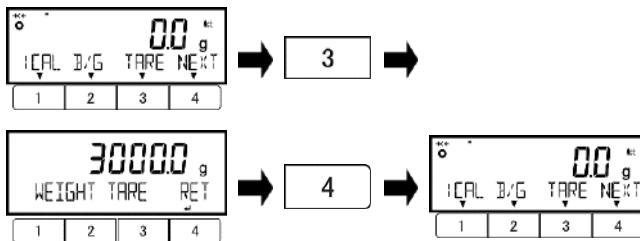

The tare weight can be checked by operating “Free keys” if the <TARE> is assigned to the Free key. (cf. “8 Controlling and adjustment functions”)  
- Press [1]-[3] key on which <TARE> is displayed above.

The tare weight is displayed on the display, then press [4] < ↩ > key to return to the measuring mode.

### 4 Put the sample on the tare.

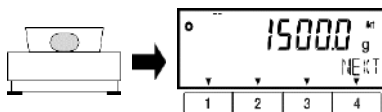

The net weight of the sample is displayed.

### 5 Clear the tare weight data.

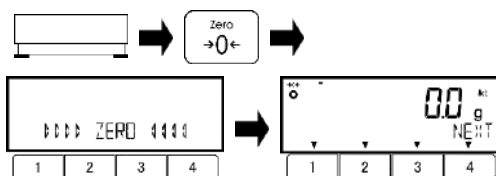

- Remove the sample and tare on the weighing pan, then press [Zero] key.

Therefore, the indication becomes zero and < Net > indication disappears.

- (1) Performing the tare narrows the weighing range as much as the amount of the tare weight mass (tare weight).

Weighable range = weighing capacity - tare weight

- (2) Stability waiting during the tare can be set using the Setting menu <17 WT STABLE>.



The setting of <17 WT STABLE> is not changeable and the scale always wait stability during the tare weight subtraction.

#### Reference

- (3) When using a tare whose tare weight is already known, the tare can be performed in advance by inputting its tare weight (preset tare). For its setting method, refer to “5 Preset tare and Comparator setting”.

- (4) When turning on the power placing a tare that exceeds the initial zero adjustment range at the time of power supply, tare subtraction is executed.



This operation is not valid.

- (5) Tare weight can be output at “Step 3 Check the tare weight” by pressing [Output] key. Check “External input/output functions” to refer the output setting.

## 2-4 Weighing the additional sample

Weigh the first sample and the additional sample separately.

### 1 Place a sample to be weighed.

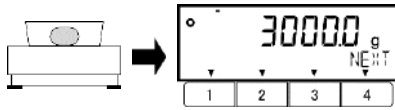

The mass of the sample to be weighed is indicated.

### 2 Perform tare subtraction.



Press [Tare] key.

The indication changes to zero and the < Net > symbol appears.

### 3 Place an additional sample to be weighed.

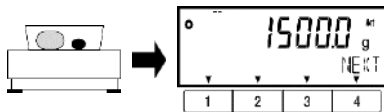

The mass of the added sample alone is indicated.

## 2-5 Basic operation

### Reference

Shortcuts for various modes/functions can be assigned to functional keys. Please refer to "8-2 Shortcut setting for accessing various measuring modes" and "8-3 Free key setting".

### 2-5-1 Hierarchy of a setting menu

The setting menu of this product is divided into four, from the first layer to the third layer and for various settings.

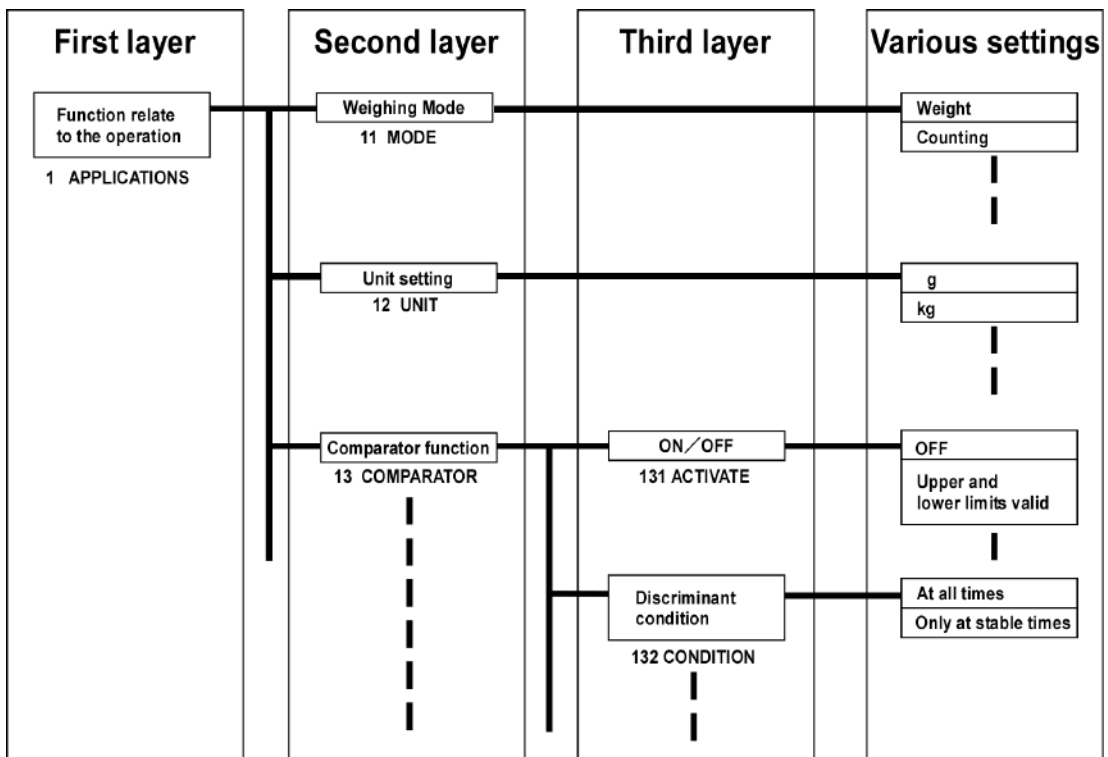

## 2-5-2 Operation of the setting menu

To perform settings for various functions from the state of weighing, chiefly execute the following procedure.

- Go to the menu item to set

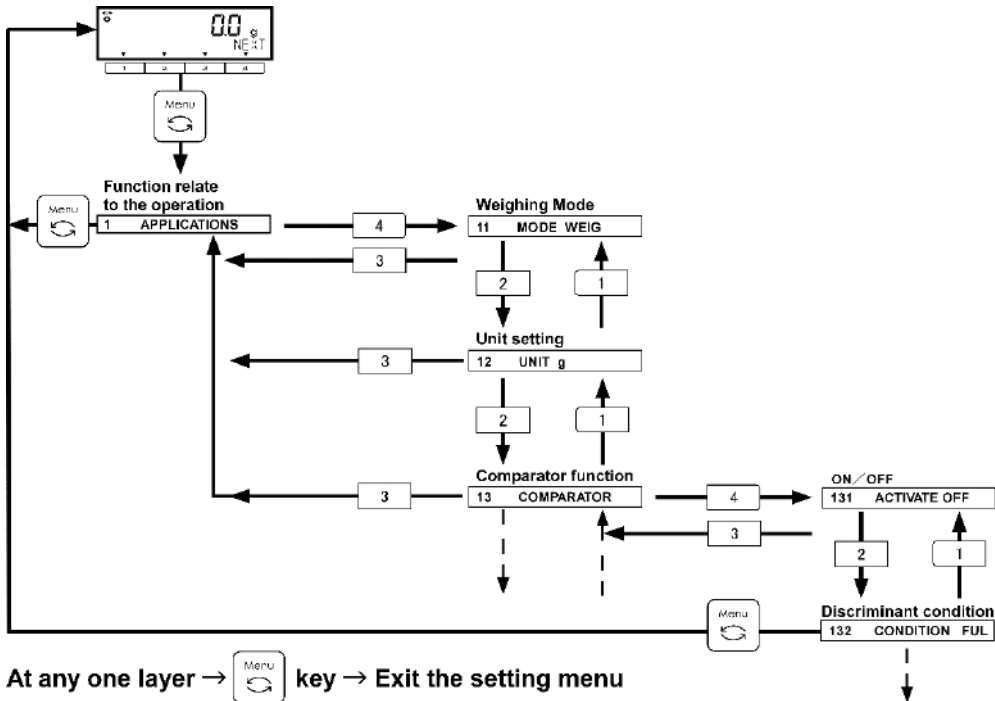

- Select the setting value and execute/fix.

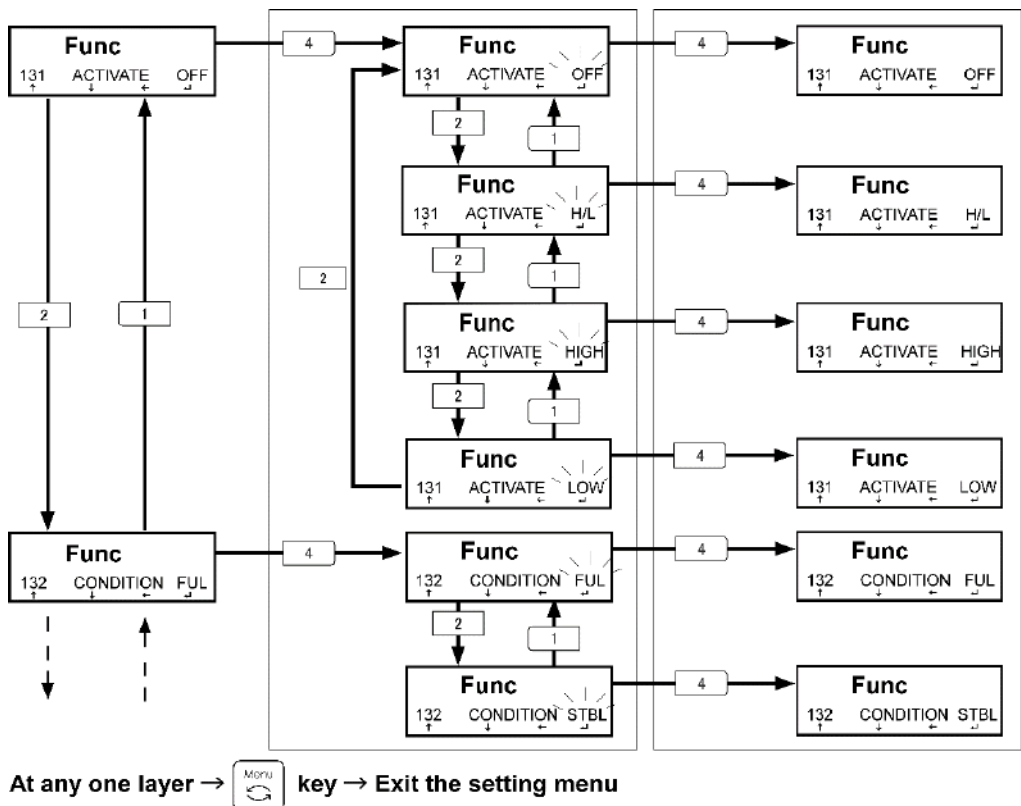

## 2-5-3 Numeric value input

Input upper/lower limit, reference weight, unit weight, preset tare weight, coefficient, date/time and ID/password at each mode.

### Reference

Numeric value inputting is limited to eight digits at a maximum.

Ex) When inputting “-5.4321”.

### 1 Input “-”.

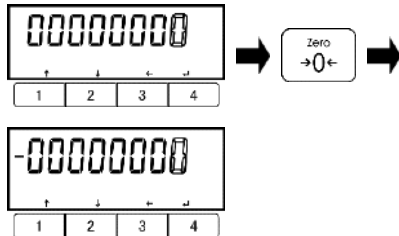

- Press [Zero] key to change the polarity to “-”.

### 2 Input “1”.

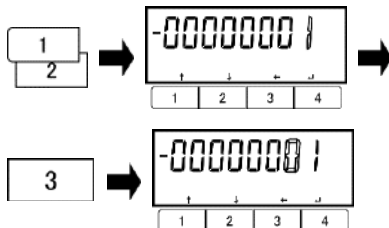

The digit for inputting is blinking.

- Press [1], [2] key to increment/decrement the digit to “1”.

- Press [3] key to input the next digit.

### 3 Input “2, 3, 4, 5”.

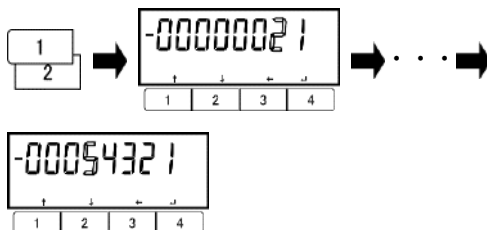

- Input “2, 3, 4, 5” by the procedure above.

### 4 Input “.”.

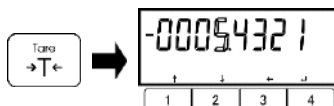

- Press [Tare] key to input “.” on the immediately right of the blinking digit.

### 5 Fix the input value.



- Press [4] key to fix the input value.

The coefficient “-5.4321” is saved on the scale.

### Reference

“-” and “.” cannot be input in ID or Password setting.  
cf. “8-5-1 Scale ID setting”

## 2-5-4 Functional keys switching at each measuring mode

You can switch the measuring mode, or select and set the function, by operating the functional keys at each measuring mode.

This chapter shows how the functions allocated to [1]-[3] keys switch by pressing [4] key.

Refer to “3 Function related to the operation” for the [1]-[3] keys operation.



“Multiplied by Coefficient mode” is not available for verified scale.

### Reference

- (1) In weighing mode, <<F1-F6>> (Free keys) are assigned to functional keys as described follow; <<F1>> and <<F4>>: [1] key, <<F2>> and <<F5>>: [2] key, <<F3>> and <<F6>>: [3] key. Please take care not to confuse <<F1-F4>> to [1]-[4] keys.
- (2) Refer to “8 Controlling and adjustment functions” for assigning “Free keys” and “Shortcuts” to functional keys.

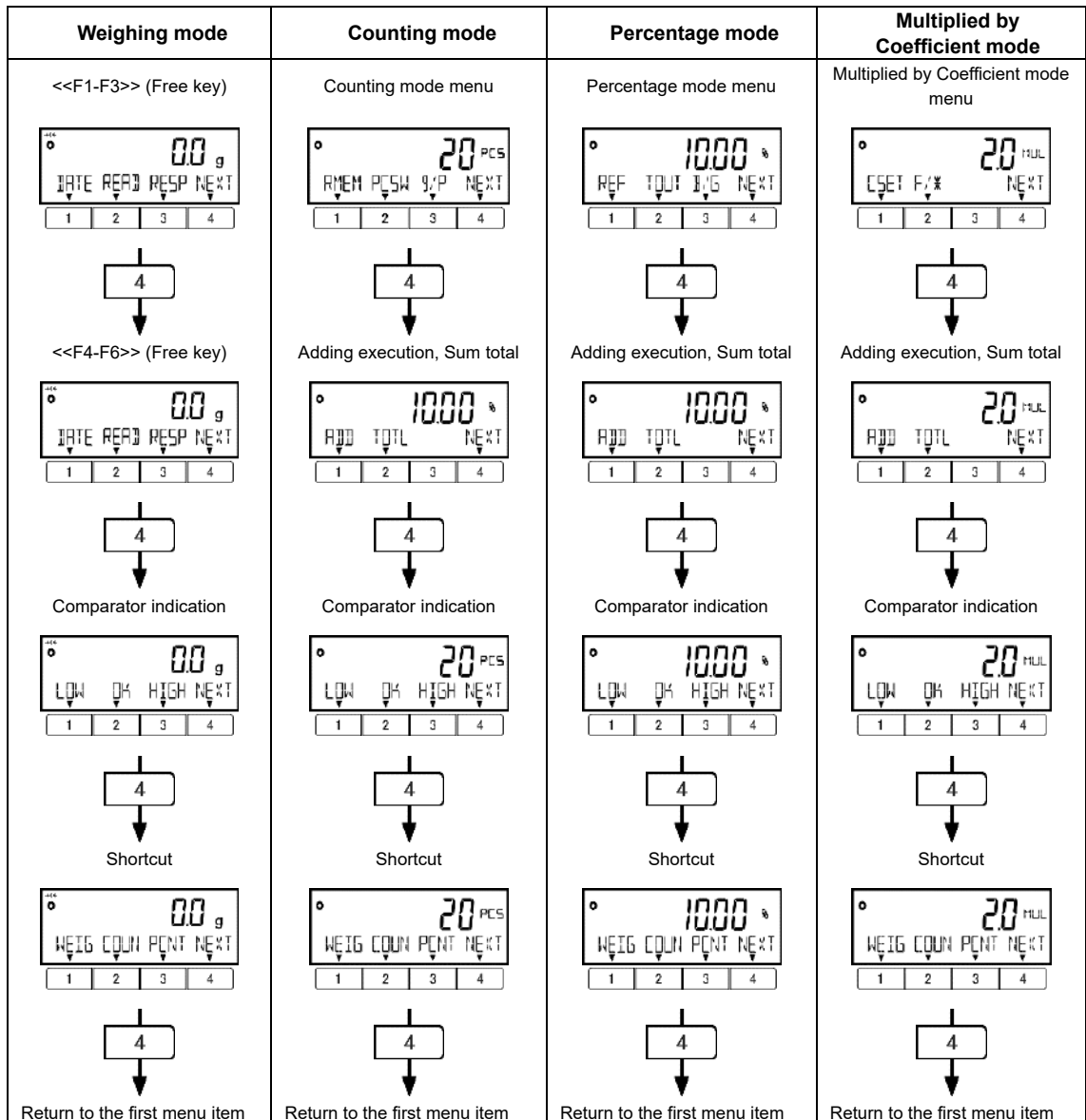

# 3 Functions related to the operation

Settings to change the scale operations.

## 3-1 Hierarchy of functions related to the operation



For verified scale:

- Grey-shaded items (  ) are not indicated;
- <17 WT STABLE> is not indicated and fixed to be <ON>.

### Reference

\*1 <1D RANGE MODE> is available only on HJ62K0.1DS(R):

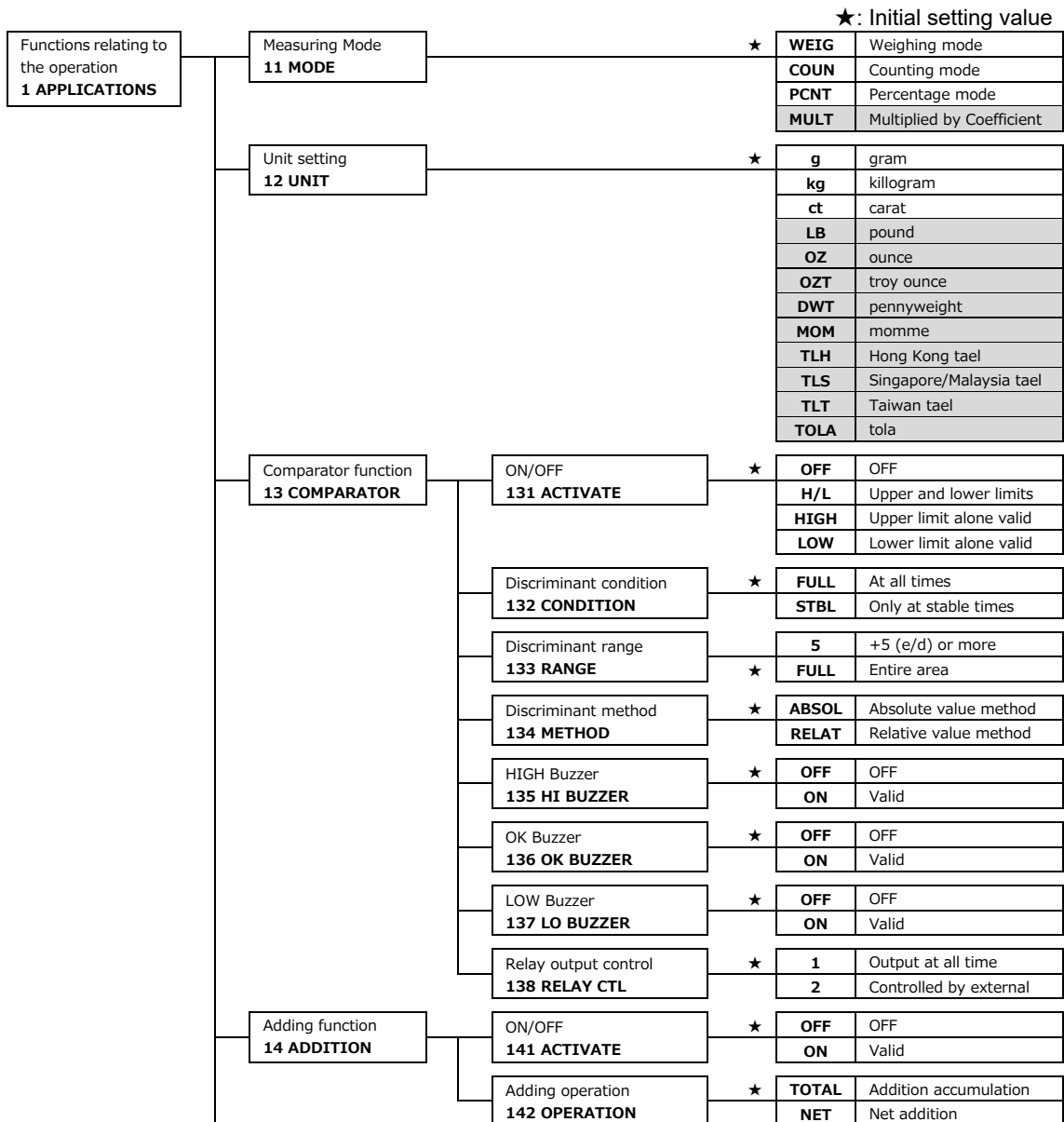

Stability waiting <b>17 WT STABLE</b>	★	<b>OFF</b>	OFF
		<b>ON</b>	Valid
Bar graph indication <b>18 BARGRAPH</b>	★	<b>OFF</b>	OFF
		<b>ON</b>	Valid
Buzzer setting <b>19 BUZZER</b>	★	<b>OFF</b>	OFF
		<b>MODE1</b>	Mode 1 valid
Back light setting <b>1A BACKLIGHT</b>	★	<b>OFF</b>	OFF
		<b>3MIN</b>	3 minutes
		<b>5MIN</b>	5 minutes
		<b>10MIN</b>	10 minutes
		<b>30MIN</b>	30minutes
Auto power-off <b>1B AUTO OFF</b>	★	<b>OFF</b>	Invalid
		<b>3MIN</b>	3 minutes
		<b>5MIN</b>	5 minutes
		<b>10MIN</b>	10 minutes
		<b>30MIN</b>	30minutes
Simplified SCS <b>1C SIMPLE SCS</b>	★	<b>OFF</b>	OFF
		<b>ON</b>	Valid
*1 Range mode setting <b>1D RANGE MODE</b>	*1 ★	<b>SGL</b>	Single-Range mode
		<b>DBL</b>	Double-Range mode



## 3-2 Various measuring modes of the scale

**Reference** Refer to "6 External input/output functions" to output the measuring data to other devices.

### 3-2-1 Weighing mode

Weighing mode is the basic mode for weighing.

**Reference** Various functions can be used with weighing mode by using the "Free key". Please refer to "8-3 Free key setting".

#### 1 Select the weighing mode.

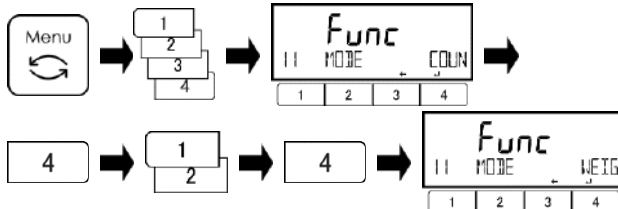

- Press [Menu] key, then press [1]-[4] keys to go to <11 MODE>.
- Press [4] key to change the setting value.
- Press [1]/[2] key to select.  
WEIG : Weighing mode
- Press [4] key to fix.

#### 2 Exit the setting menu.



- Press [Menu] key to shift to the weighing mode.

#### 3 Execute tare subtraction

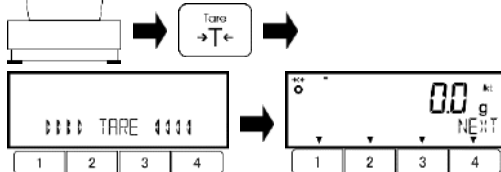

- Place the container on the weighing pan if necessary.
- Press [Tare] key  
Tare-subtraction is executed, then the indication changes to zero and the <Net> symbol lights.

#### 4 Weigh the sample.

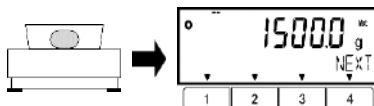

- Place the sample.  
The weighing result is displayed.

### 3-2-2 Counting mode



This mode is not legal for trade.

Counting mode can count the number of items by placing the items for which sampling has been completed on the scale and dividing the total weight of those items by the recorded unit weight. There are two methods to input the unit weight;

- Actual value setting method : Place the specified number of samples on the scale to record the average unit weight.
- Numeric value setting method : Input numeric value of the unit weight by key operation.

#### 1 Select the Counting mode.

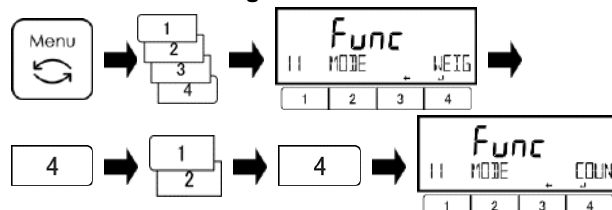

- Press [Menu] key, then press [1]-[4] keys to go to <11 MODE>.
- Press [4] key to change the setting value.
- Press [1]/[2] key to select.  
COUN: Counting mode
- Press [4] key to fix.

#### 2 Exit the setting menu.



- Press [Menu] key to shift to the Counting mode.

## 3-2-2 (1) Actual value setting method

Place the specified number of samples on the scale to record the average unit weight internally.

### 1 Select whether or not employ the previous recorded unit weight.



- Press [3]/[4] key to select whether or not employ the previous data.

When there is no data record, this step is skipped.

- Press [3]/[4] key to select.

NO: Change

YES: Not Change

When <OK> is selected, go to step 6.

### 2 Select the "number of samples mode".

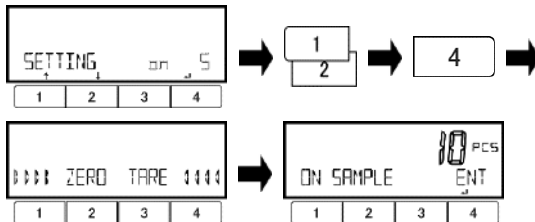

- Press [1]/[2] key to select.

on 5 : 5 PCS

on 10 : 10 PCS

on 30 : 30 PCS

on 50 : 50 PCS

on 100 : 100 PCS

on VAR : 1 – 999 PCS

PCSWGT : Numeric value setting method

See 3-2-2(2)

- Press [4] key to fix.

Zero-point adjustment or tare is set automatically.

### 3 Place the samples.

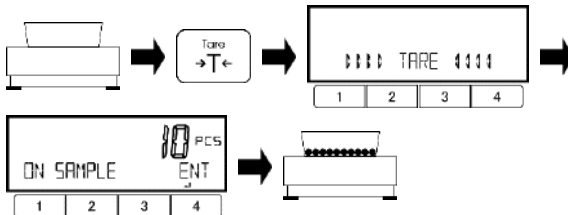

- Place a container (tare) on the weighing pan.

- Press [Tare] key.

- Place the set number of samples on the weighing pan.

### 4 Record the unit weight.

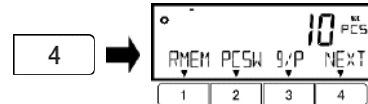

- Press [4] key to fix.

The unit weight is recorded.

### 5 Simple SCS method (When enabled).

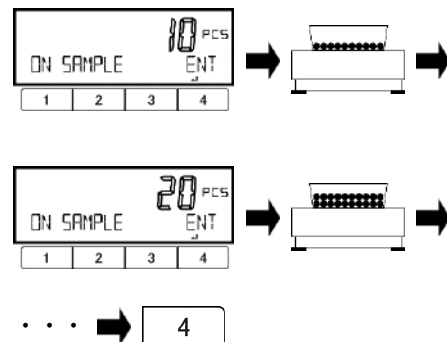

When <1C Simple SCS> is valid and <on 5> through <on 100> or <on VAR> is selected in step 2, Simple SCS method is activated and the sample counting indication blinks during this function.

- Add more samples, then the number of samples and unit weight is automatically updated when the indication becomes stable. The number of additional samples can be up to two times the number of the samples of the latest update.

For example, when "10 PCS" is set, add 20 or less samples.

- Repeat this step until the number of the samples has reached approximately one-fifth to one-half of the total numbers that you are intended to count.

- Press [4] key to fix the updated unit weight.

### 6 Put samples in place to count them.

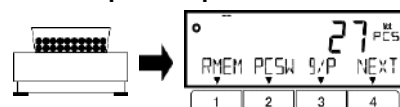

- Place the samples.

Count result is displayed.

**Reference**

- (1) When <on VAR> is selected in step 2, select the specified number of the sample among 1 to 999 by operating [1]/[2] keys.
- (2) When simple SCS is operating, if the weight of the samples is less than 99 times of the readability ( $d \times 99$ ), <Add> blinks on the display and unit weight cannot be updated.

In this case, add samples until <Add> indication disappears, or select the larger number of samples in step 2.

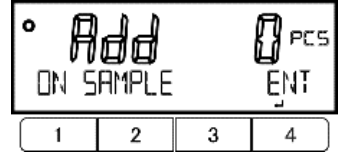

- (3) When simple SCS is operating, if the number of the additional samples is larger than two times of the sample number of latest update, <Sub> blinks on the display and unit weight cannot be updated.

In this case, decrease the number of additional samples.

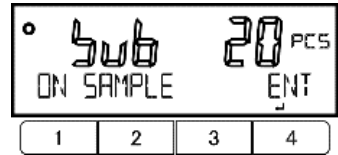

### 3-2-2 (2) Numeric value setting method

Input numeric value of the unit weight by key operation.

- 1 Select whether or not employ the previous recorded unit weight.



- Press [3]/[4] key to select whether or not employ the previous data.

When there is no data record, this step is skipped.

- Press [3]/[4] key to select.

NO: Change

YES: Not Change

When <YES> is selected, go to step 4.

- 2 Select the "unit weight value input mode".

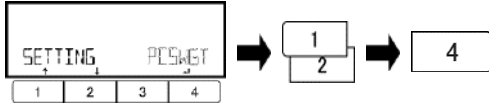

- Press [1]/[2] key to select.

PCSWGT: Unit weight value input

- Press [4] key to fix.

- 3 Input the unit weight.

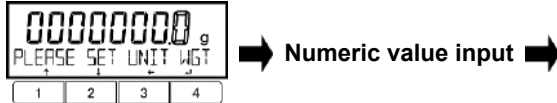

- Input the unit weight.

- Press [4] key to fix.

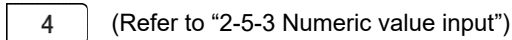

- 4 Put samples in place to count result.



- Place a container (tare) on the weight pan.

- Press [Tare] key.

- Place the samples.

The count result is displayed.

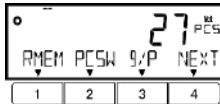

### 3-2-2 (3) Switching the display at Counting mode

- 1 Press [1]-[4] keys to switch the display.

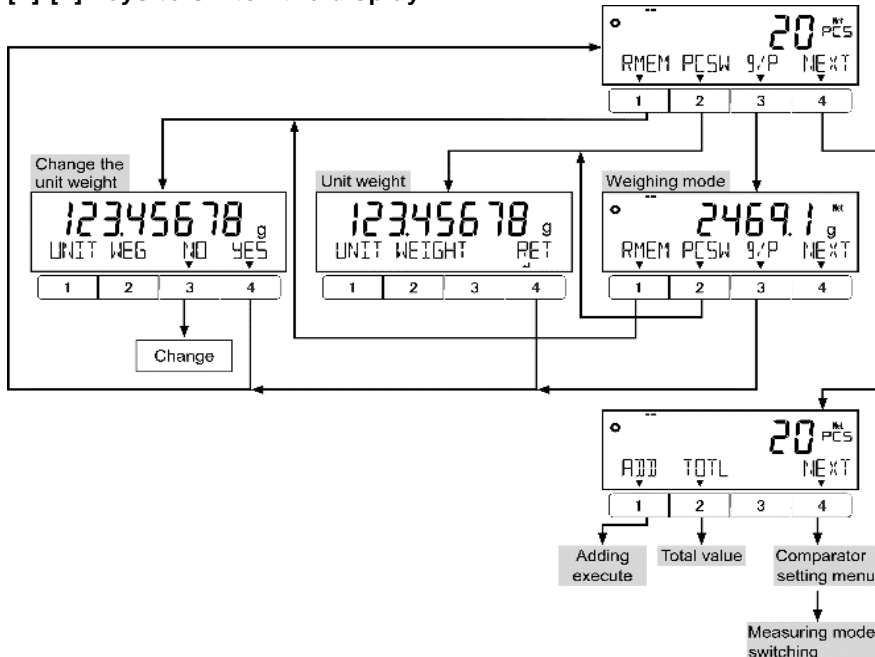

#### Reference

<ADD> and <TOTL> can be used when the <14 ADDITION> is "Valid".

### 3-3 Percentage mode



This mode is not legal for trade.

The weight of a sample to be weighed is indicated in percent relative to the reference weight. There are two methods to input the reference weight;

- Actual value setting method ([onW]) :Place the reference weight on the scale to record the weight.
- Numeric value setting method ([NUM]):Input numeric value of the reference weight by key operation.

- (1) The lower limit of the reference weight: Refer to “Annex 1-1 Basic specifications”
- (2) The readability is automatically set according to the recorded reference weight.

Reference

Readability (%)	Range of reference weight	
1	10 g <=	Reference weight < 100 g
0.1	100 g <=	Reference weight < 1000 g
0.01	1000 g <=	Reference weight

#### 1 Select the percentage mode.

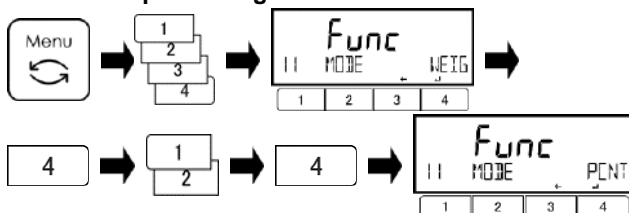

- Press [Menu] key, then press [1]-[4] keys to go to <11 MODE>.
- Press [4] key to change the setting value.
- Press [1]/[2] key to select.
- PCNT : Percentage mode
- Press [4] key to fix.

#### 2 Exit the setting menu.

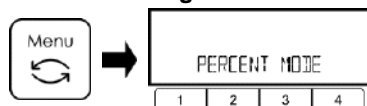

- Press [Menu] key to shift to the percentage mode.

#### 3 Select whether or not employ the previous recorded reference value.

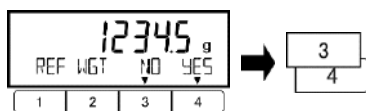

- Press [3]/[4] key to select whether or not employ the previous data. When there is no data record, this step is skipped.
- Press [3]/[4] key to select.
- NO : Change
- YES : Not Change
- When <OK> is selected, go to step 6.

#### 4 Select the method of setting the reference value.

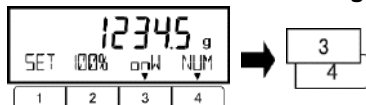

- Press [3]/[4] key to select.
- onW : Actual value
- NUM : Numeric value

#### 5 Save the reference value.

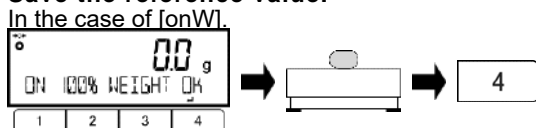

- Place the reference weight on the scale.
- Press [4] key to record.



- Input the reference value.
- Press [4] key to fix.

(Refer to “2-5-3 Numeric value input”)

#### 6 Weigh the samples.

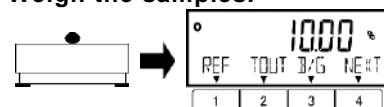

The ratio of the weight of the sample to the reference weight is indicated in percent.

### 3-3-1 Switching the display at percentage mode

**1** Press [1]-[4] keys to switch the display.

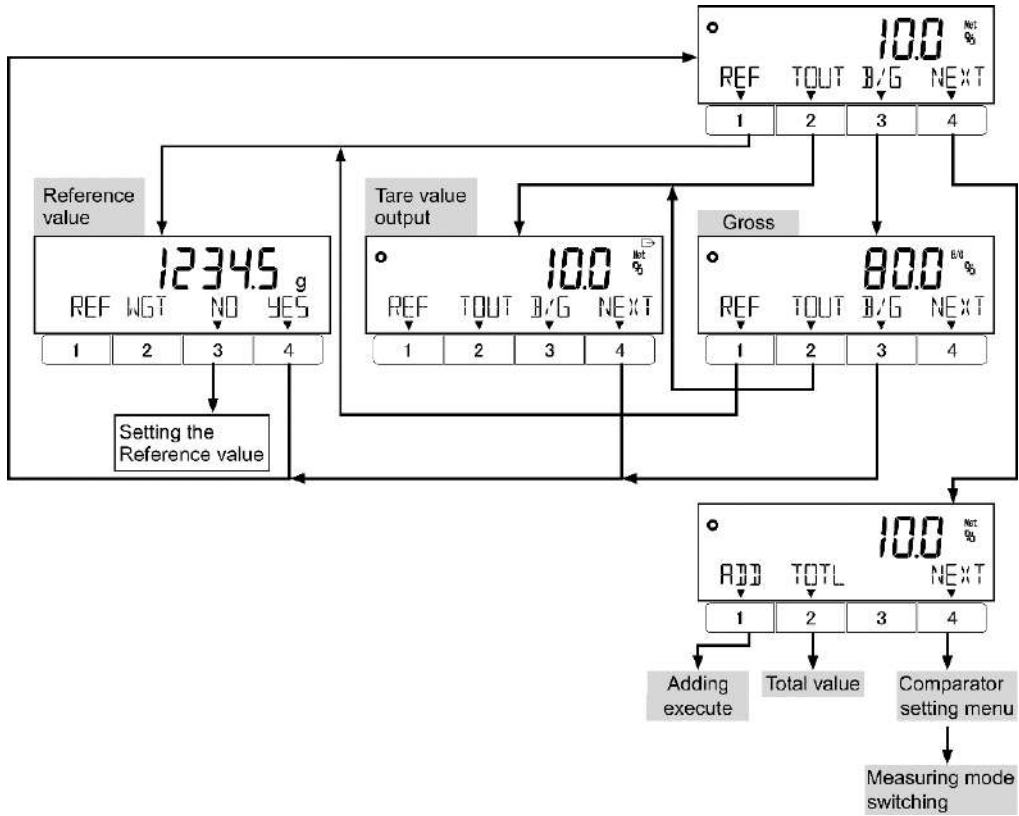

**Reference**

<ADD> and <TOTL> can be used when the <14 ADDITION> is activated.

## 3-4 Multiplied by Coefficient mode

Measured weight is multiplied by the pre-set coefficient, and the result is displayed.



This mode is not available for verified scale.

### 1 Select the Multiplied by Coefficient mode.

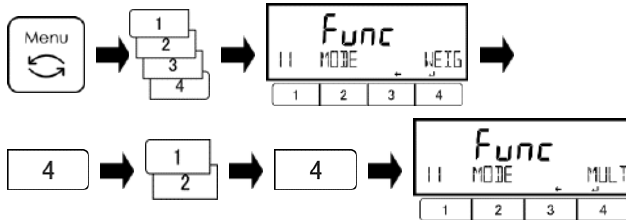

- Press [Menu] key, then press [1]-[4] keys to go to <11 MODE>.

- Press [4] key to change the setting value.

- Press [1]/[2] key to select.

MULT : Multiplied by Coefficient mode

- Press [4] key to fix.

### 2 Exit the setting menu.



- Press [Menu] key to shift to the Multiplied by Coefficient mode.

### 3 Select whether or not employ the previous recorded coefficient.

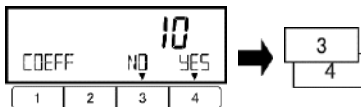

- Press [3]/[4] key to select whether or not employ the previous data.

When there is no data record, this step is skipped.

- Press [3]/[4] key to select.

NO: Change

YES: Not Change

When <OK> is selected, go to step 6.

### 4 Set the coefficient.

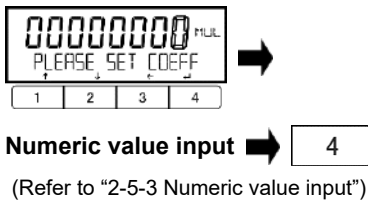

- Input the coefficient.

- Press [4] key to fix.

### 5 Weigh the samples.

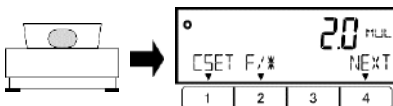

The weight of the sample is multiplied by the coefficient and the result is displayed.

### 3-4-1 Switching the display at Multiplied by Coefficient

**1** Press [1]-[4] keys to switch the display.

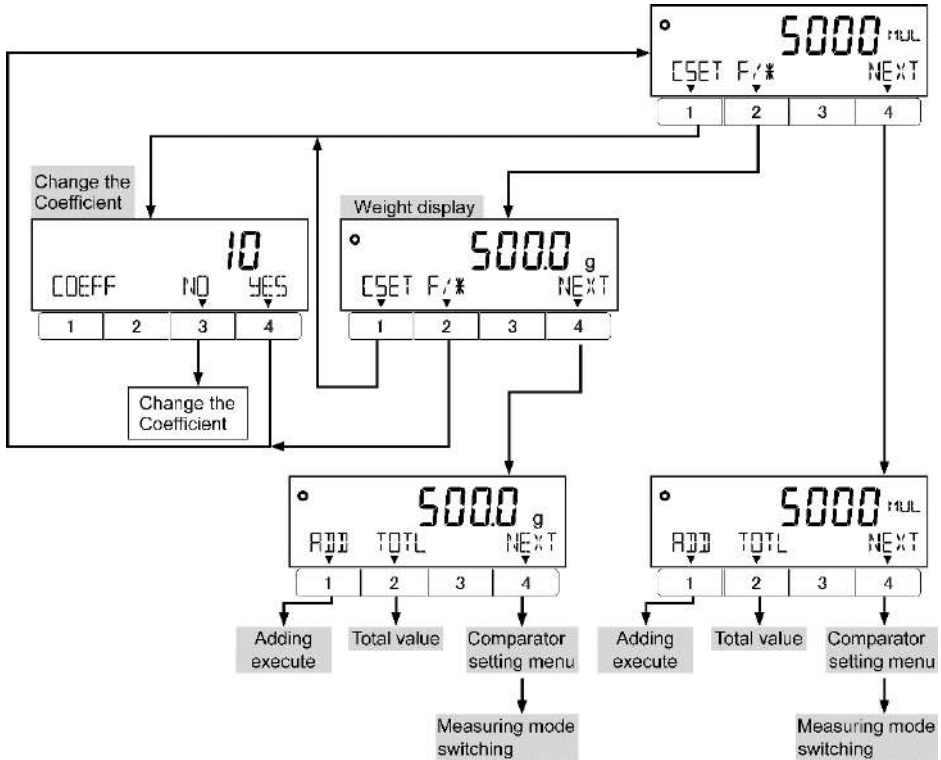

**Reference** <ADD> and <TOTL> can be used when the <14 ADDITION> is "Valid".

### 3-5 Unit setting

Various units can be selected. Please also refer to "Appendix 3 Unit conversion table" and "Appendix 4 Weighing capacity and readability by unit"

**Legal Metrology** Only "g", "kg" and "ct" are available for verified scale.

**1** Select the unit setting.

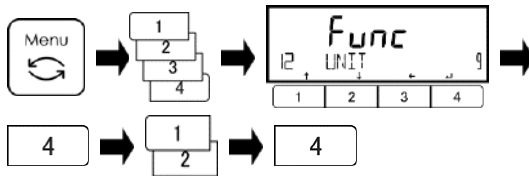

- Press [Menu] key, then press [1]-[4] keys to go to <12 UNIT>.
- Press [4] key to change the setting value.
- Press [1]/[2] key to select the unit (Refer to Unit Setting Menu List).
- Press [4] key to fix.

g : gram	kg : kilogram	ct : carat	LB : pound
OZ : ounce	OZT : troy ounce	DWT : pennyweight	MOM : momme
TLH : Hong Kong tael	TLS : Singapore, Malaysia tael		TLT : Taiwan tael
TOLA : tola			

**2** Exit the setting menu.

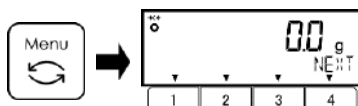

- Press [Menu] key to shift to the measuring modes.



## 3-6 Comparator function

It is possible to preset threshold values (limits) and determine whether or not a measured value is within the range defined by the preset values.

Refer to “5 Preset tare and Comparator setting” to preset the threshold values.

### Reference

The comparator function can be used in Weighing mode, Percentage mode, Counting mode, and Multiplied by Coefficient mode.

### 3-6-1 How to perform discrimination

Switch to the “Comparator indication” according to “2-5-4 Functional keys switching at each measuring mode”. Whether the weight of a sample to be weighed is “LOW” (lower than the lower limit), “OK” (appropriate) or “HIGH” (higher than the upper limit), is indicated on the LCD with “16-segment messages”.

16-segment messages				
Discrimination	Single point setting (lower limit)	Single point setting (upper limit)	Two-point setting (upper and lower limits)	
Over the upper limit	< OK > Blinking	< HIGH > Blinking	< HIGH > Blinking	
Appropriate amount	< OK > Blinking	< OK > Blinking	< OK > Blinking	
Below the lower limit	< LOW > Blinking	< OK > Blinking	< LOW > Blinking	

The discrimination is performed according to the following criteria:

- Absolute value: The discrimination is performed based on the upper and lower limit values that have been set in advance.
- Relative value: A reference numeric value is set in advance, and the discrimination is performed based on the range defined by the upper and lower limit values that have been set for the reference numeric value.

(For example) Two-point (upper and lower limits) setting, Reference value = 1000.0 g,  
Lower limit value = 900.0 g, Upper limit value = 1200.0 g

Discrimination method	Reference value	Lower limit value	Upper limit value
	1000.0 g	900.0 g	1200.0 g
Absolute value		900.0 g	1200.0 g
Relative value	1000.0 g	-100.0 g	200.0 g

## 3-6-2 Comparator function setting

### Reference

- When to use HI/OK/LO buzzer, be sure to set <19 BUZZER> to ON.  
(Refer to 3-12 Buzzer setting.)
- Lower limit, reference and upper limit can be also set by [1](LOW) key, [2](OK) key and [3](HIGH) key at "comparator indication" display.

### 1 Select the comparator function.

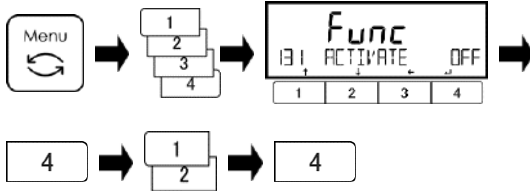

- Press [Menu] key, then press [1]-[4] keys to go to <131 ACTIVATE>
- Press [4] key to change the setting value.
- Press [1]/[2] key to select.

OFF: OFF  
H / L: Upper and lower limits valid  
HIGH: Upper limit alone valid  
LOW: Lower limit alone valid

- Press [4] key to fix.

### 2 Select the discriminant condition.

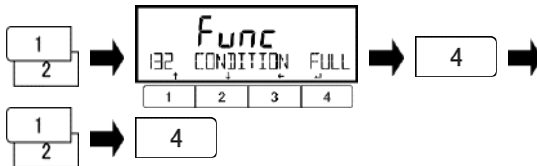

- Press [1]-[2] keys to go to <132 CONDITION>
- Press [4] key to change the setting value.
- Press [1]/[2] key to select.

FULL: At all times  
STBL: Only at stable times

- Press [4] key to fix.

### 3 Select the discriminant range.

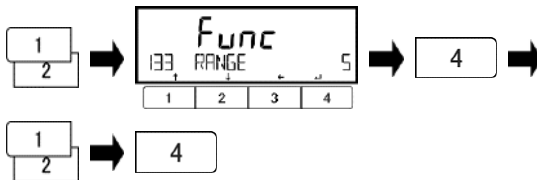

- Press [1]-[2] keys to go to <133 RANGE>
- Press [4] key to change the setting value.
- Press [1]/[2] key to select.

5: +5 (e/d) or more  
FULL: Entire area

- Press [4] key to fix.

### 4 Select the discriminant method.

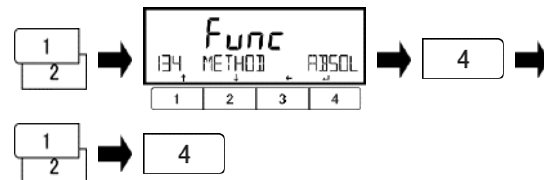

- Press [1]-[2] keys to go to <134 METHOD>
- Press [4] key to change the setting value.
- Press [1]/[2] key to select.

ABSOL: Absolution value method  
RELAT: Relative value method

- Press [4] key to fix.

### 5 Set HI buzzer

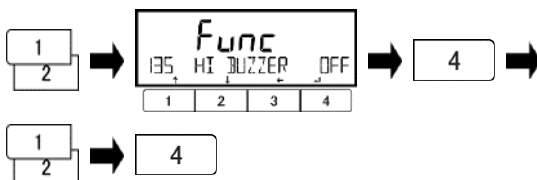

- Press [1]-[2] keys to go to <135 HI BUZZER>
- Press [4] key to change the setting value.
- Press [1]/[2] key to select.

OFF: OFF  
ON: Active when above upper limit

- Press [4] key to fix.

### 6 Set OK buzzer

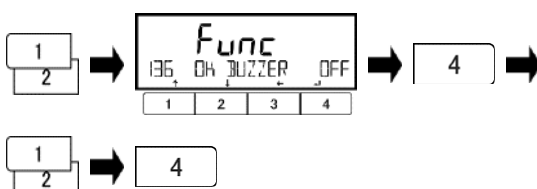

- Press [1]-[2] keys to go to <136 OK BUZZER>
- Press [4] key to change the setting value.
- Press [1]/[2] key to select.

OFF: OFF  
ON: Active when discriminant result is OK

- Press [4] key to fix.

# 7

## Set LO buzzer

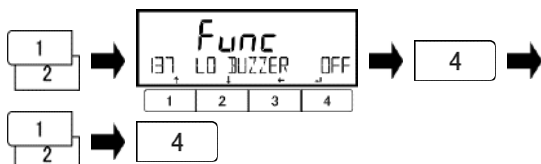

- Press [1]-[2] keys to go to <137 LO BUZZER>
- Press [4] key to change the setting value.
- Press [1]/[2] key to select.
- OFF: OFF
- ON : Active when below lower limit
- Press [4] key to fix.

# 8

## Select relay output control

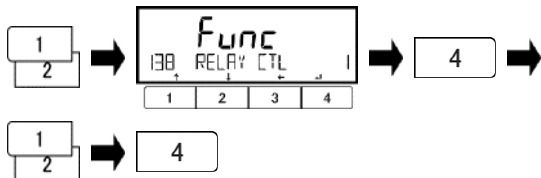

- This item is for optional relay output.
- Press [1]-[2] keys to go to <138 RELAY CTL>
  - Press [4] key to change the setting value.
  - Press [1]/[2] key to select.
  - 1: Output at all time
  - 2: Controlled by external input
  - Press [4] key to fix.

### 3-7 Adding function

Weigh a plurality of samples to be weighed in sequence and indicates its total value.  
The adding function includes two ways of calculating method.

- Method of weighing samples to be weighed while Addition accumulating function. replacing the samples:
- Method of weighing samples to be weighed without Net adding function. replacing the samples:

#### Reference

The adding function can be used in Weighing mode, Percentage mode, Counting mode, and Multiplied by Coefficient mode.

# 1

## Select the adding function.

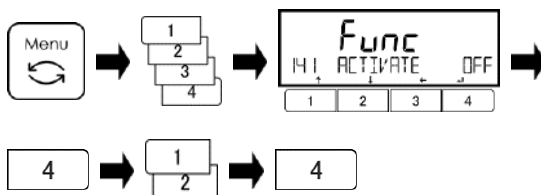

- Press [Menu] key, then press [1]-[4] keys to go to <141 ACTIVATE>
- Press [4] key to change the setting value.
- Press [1]/[2] key to select.
- OFF: Invalid
- ON: Valid
- Press [4] key to fix.

# 2

## Select the adding operation.

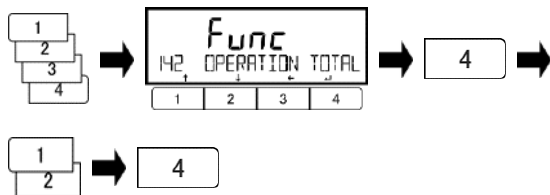

- Press [1]-[4] keys to go to <142 OPERATION>
- Press [4] key to change the setting value.
- Press [1]/[2] key to select.
- TOTAL: Addition accumulated
- NET: Net addition
- Press [4] key to fix.

# 3

## Set the "Free key".

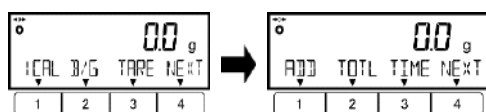

- Set the following function to the <<F1-F6>> (Free keys).
- <62\* F\* KEY ADD> : Adding execute
- <62\* F\* KEY TOTL>: Total indication
- (Refer to "8 Controlling and adjustment functions" for setting the free keys.)

#### Reference

Step 3 is required only when you are using an adding function on the weighing mode.

### 3-7-1 Weighing by means of addition

When <ADD> is assigned to [1] key and <TOTL> is assigned to [2] key.

#### 1 Place a first sample to be weighed.

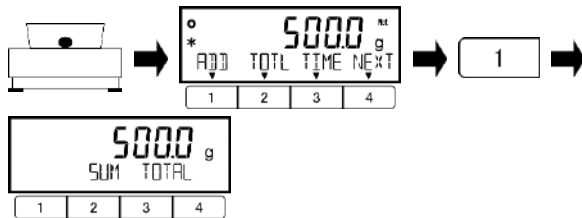

- Place a first sample to be weighed.
- After < \* > appears, press [1](<<ADD>>) key.

The weighed value is stored and <SUM TOTAL> is indicated for a few seconds.

#### 2 In the case of the addition accumulating Replace a sample to be weighed with a new one.

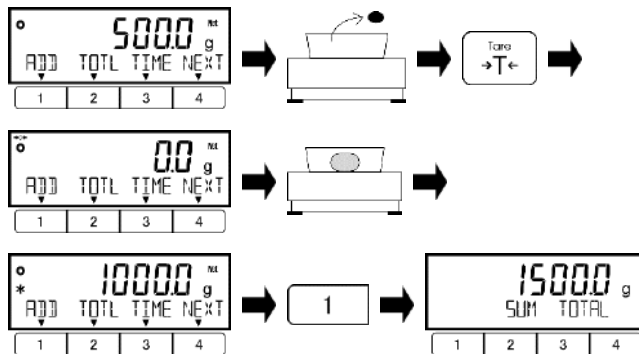

- The scale returns to the weight indication.
- Remove the previous sample and press [Tare] key.
- Then place a next sample to be weighed.
- After < \* > appears, press [1](<<ADD>>) key.

The weighed value is stored and <SUM TOTAL> is indicated for a few seconds.

- Repeat this operation to perform addition.

#### In the case of the net addition Add a sample to be weighed.

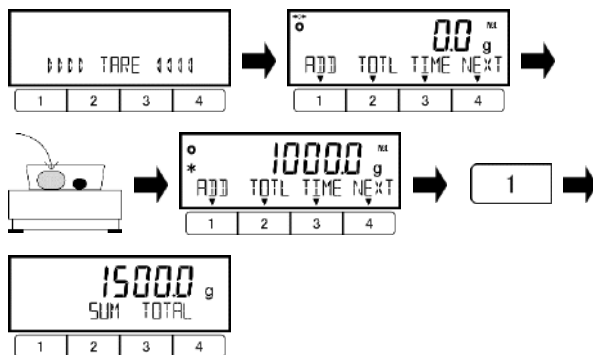

- Tare subtraction starts automatically after <SUM TOTAL> indication, then the scale returns to net-zero indication.
- Add a sample to be weighed without doing any other operation.
- After < \* > appears, press [1](<<ADD>>) key.

The weighed value is stored and <SUM TOTAL> is indicated for a few seconds.

- Repeat this operation to perform addition.

#### 3 Indicate the total value.

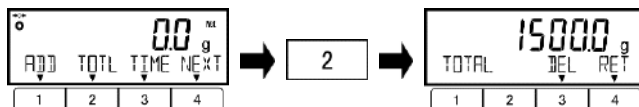

- Press [2](<<TOTL>>) key.
- Total value is indicated.

#### 4 Delete the total value.

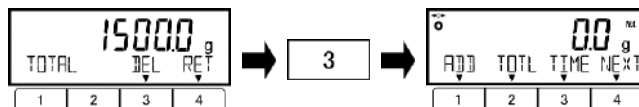

- Press [3](<DEL>) key.
- The total value is deleted.

### 3-8 Stabilization wait setting

Set when to indicate the weighed value after the zero-point adjustment or tare; either after or before the weighed value stabilizes.



For verified scale:

- This setting menu is not available;
- The scale always wait stabilization before indicating weighed value after the zero-point adjustment or tare.

#### 1 Select the stabilization wait setting.

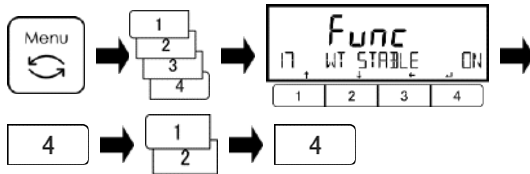

- Press [Menu] key, then press [1]-[4] keys to go to <17 WT STABLE>.
- Press [4] key to change the setting value.
- Press [1]/[2] key to select.  
OFF: Invalid  
ON: Valid
- Press [4] key to fix.

#### 2 Exit the setting menu.

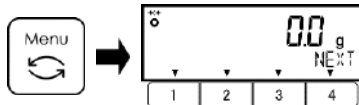

- Press [Menu] key to shift to the measuring mode.

### 3-9 Bar graph indication

Set the indication/non-indication of the bar graph.

#### 1 Select the bar graph indication.

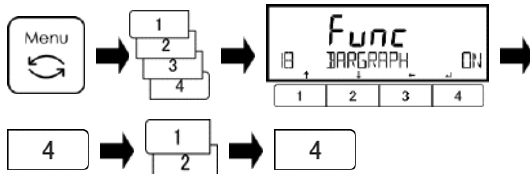

- Press [Menu] key, then press [1]-[4] keys to go to <18 BARGRAPH>.
- Press [4] key to change the setting value.
- Press [1]/[2] key to select.  
OFF: Invalid  
ON: valid
- Press [4] key to fix.

#### 2 Exit the setting menu.

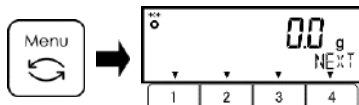

- Press [Menu] key to shift to the measuring mode.

### 3-10 Backlight setting

Setting the backlight control.

#### 1 Select the backlight setting.

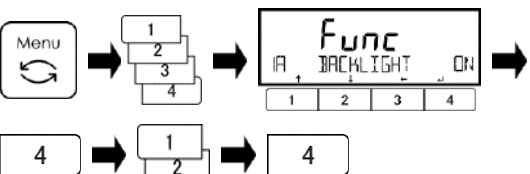

- Press [Menu] key, then press [1]-[4] keys to go to <1A BACKLIGHT>.
- Press [4] key to change the setting value.
- Press [1]/[2] key to select.  
Refer to the "Set List".
- Press [4] key to fix.

#### Set List

OFF : Invalid	3MIN : 3 minutes	5MIN : 5 minutes
10MIN : 10 minutes	30MIN : 30 minutes	ON : Always ON

#### 2 Exit the setting menu.

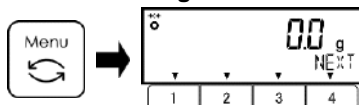

- Press [Menu] key to shift to the measuring mode.

#### Reference

For accurately weighing, please set <1A BACKLIGHT> to continuously "ON" or "OFF".

When the scale is battery powered, it is recommended to set backlight settings to continuously "OFF" to save the power.

### 3-11 Auto power-off

This function is to automatically turn off the power for the scale.

#### 1 Select the auto power-off.

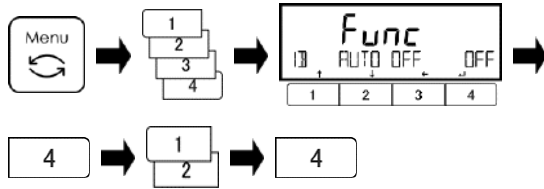

- Press [Menu] key, then press [1]-[4] keys to go to <1B AUTO OFF>.
- Press [4] key to change the setting value.
- Press [1]/[2] key to select.
- Refer to the "Set List".
- Press [4] key to fix.

Set List		
OFF : Invalid	3MIN : 3 minutes	5MIN : 5 minutes
10MIN : 10 minutes	30MIN : 30 minutes	

#### 2 Exit the setting menu.

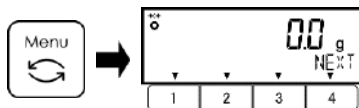

- Press [Menu] key to shift to the measuring mode.

The "Backlight setting" and "Auto power-off" function does not work under the following conditions:

#### Reference

- (1) Setting menu is being displayed.
- (2) A sample is placed on the weighing pan and the display is not stable (When < ● > is not displayed.).

### 3-12 Buzzer setting

Setting buzzer.

Buzzer beeps when:

- Unit weight is updated automatically with Simple SCS function at Counting mode;
- Weight to be added is imported at Adding function;
- Error is occurred;
- Battery goes flat when the scale is battery operated;
- Weight is discriminated at Comparator function.

#### 1 Select the buzzer setting.

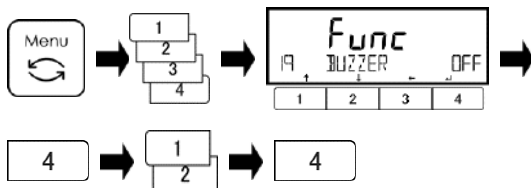

- Press [Menu] key, then press [1]-[4] keys to go to <19 BUZZER>.
- Press [4] key to change the setting value.
- Press [1]/[2] key to select.
- OFF: Invalid
- MODE1: On
- Press [4] key to fix.

#### 2 Exit the setting menu.

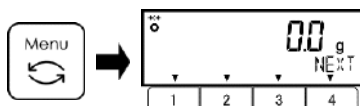

- Press [Menu] key to shift to the measuring mode.

### 3-13 “Simple SCS(Self Counting System) method” setting

“Simple SCS method” is auxiliary function for Counting mode.

First, put a set number of samples in place. Next, put up to two times the set number of additional samples in place. The scale will automatically update the average sample weight. Repeating this step allows accurate counting.

#### 1 Select the simple SCS.

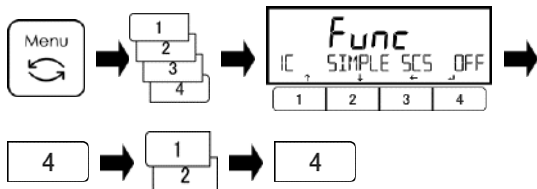

- Press [Menu] key, then press [1]-[4] keys to go to <1C SIMPLE SCS>.

- Press [4] key to change the setting value.

- Press [1]/[2] key to select.

OFF: Invalid

ON: Valid

- Press [4] key to fix.

#### 2 Exit the setting menu.



- Press [Menu] key to shift to the measuring mode.

### 3-14 Range mode setting

This function is to enable/disable automatic readability(d) switching of HJ62K0.1DS(R) (double-range model).

Single-range mode : Double-range mode is disabled, readability(d) is fixed to larger range and does not switch automatically according to the load.

Double-range mode : Available only on HJ62K0.1DS(R).

Readability automatically switches according the GROSS weight of the load.

#### 1 Select the range mode setting.

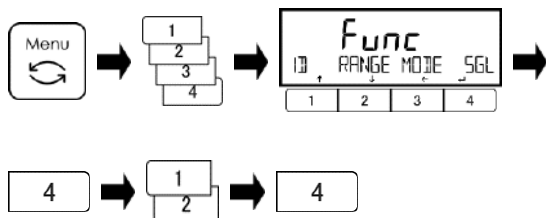

- Press [Menu] key, then press [1]-[4] keys to go to <1D RANGE MODE>.

- Press [4] key to change the setting value.

- Press [1]/[2] key to select.

SGL: Single-range mode

DBL: Double-range mode ON for HJ62K1DS(R)

- Press [4] key to fix.

#### 2 Exit the setting menu.

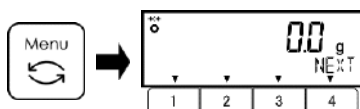

- Press [Menu] key to shift to the measuring mode.

# 4 Functions related to the performance

Set the scale indication stability and response speed.

## 4-1 Hierarchy of functions related to the performance



For verified scale, grey-shaded items (  ) are not indicated.

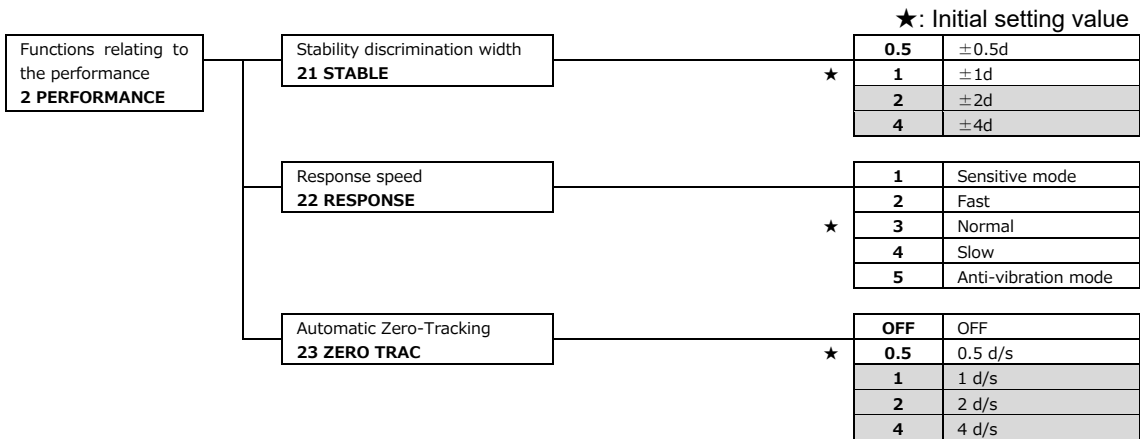

## 4-2 Stability discrimination width

When the larger numeric value is set in this setting menu, the laxer stability judgement is applied and the scale indicate "Stable mark" < ● > in more unstable conditions.



For verified scale, <21 STABLE 2,4> are not available.

### 1 Select the stability discrimination width.

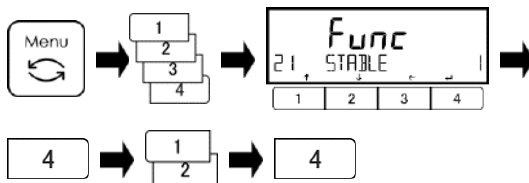

- Press [Menu] key, then press [1]-[4] keys to go to <21 STABLE>.

- Press [4] key to change the setting value.

- Press [1]/[2] key to select.

0.5: 0.5d

1: 1.0d

2: 2.0d

4: 4.0d

- Press [4] key to fix.

### 2 Exit the setting menu.

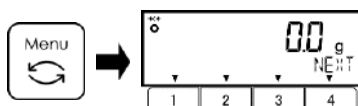

- Press [Menu] key to shift to the measuring mode.



## 4-3 Response speed

The larger numeric value is set in this setting menu, the more stable the scale indication becomes in unstable conditions.

### 1 Select the response speed.

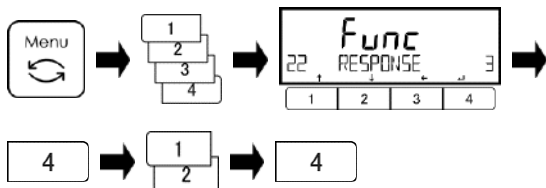

- Press [Menu] key, then press [1]-[4] keys to go to <22 RESPONSE>.

- Press [4] key to change the setting value.

- Press [1]/[2] key to select.

Refer to Set List.

- Press [4] key to fix.

Set list

1 : Sensitive mode

2 : Fast

3 : Normal

4 : Slow

5 : Anti-vibration mode

### 2 Exit the setting menu.

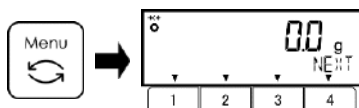

- Press [Menu] key to shift to the measuring mode.

## 4-4 Zero tracking

Setting to the zero-tracking function makes it possible to automatically correct the zero-point fluctuation caused by the temperature fluctuation, etc. when "0" is indicated, through which the "0" indication is maintained.



For verified scale, <23 ZERO TRAC 1, 2 and 4> are not available.

### 1 Select the zero tracking.

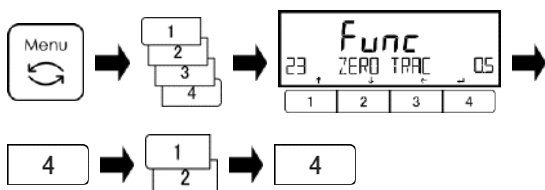

- Press [Menu] key, then press [1]-[4] keys to go to <23 ZERO TRAC>.

- Press [4] key to change the setting value.

- Press [1]/[2] key to select.

Refer to Set List.

- Press [4] key to fix.

Set list

OFF : Invalid

0.5 : 0.5d

1 : 1d

2 : 2d

4 : 4d

### 2 Exit the setting menu.

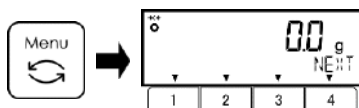

- Press [Menu] key to shift to the measuring mode.

# 5 Preset tare and Comparator setting

Describes about setting items related to the preset tare weight and comparator function.

## 5-1 Hierarchy of Preset tare and Comparator setting



For verified scale, grey-shaded items (  ) are not indicated.

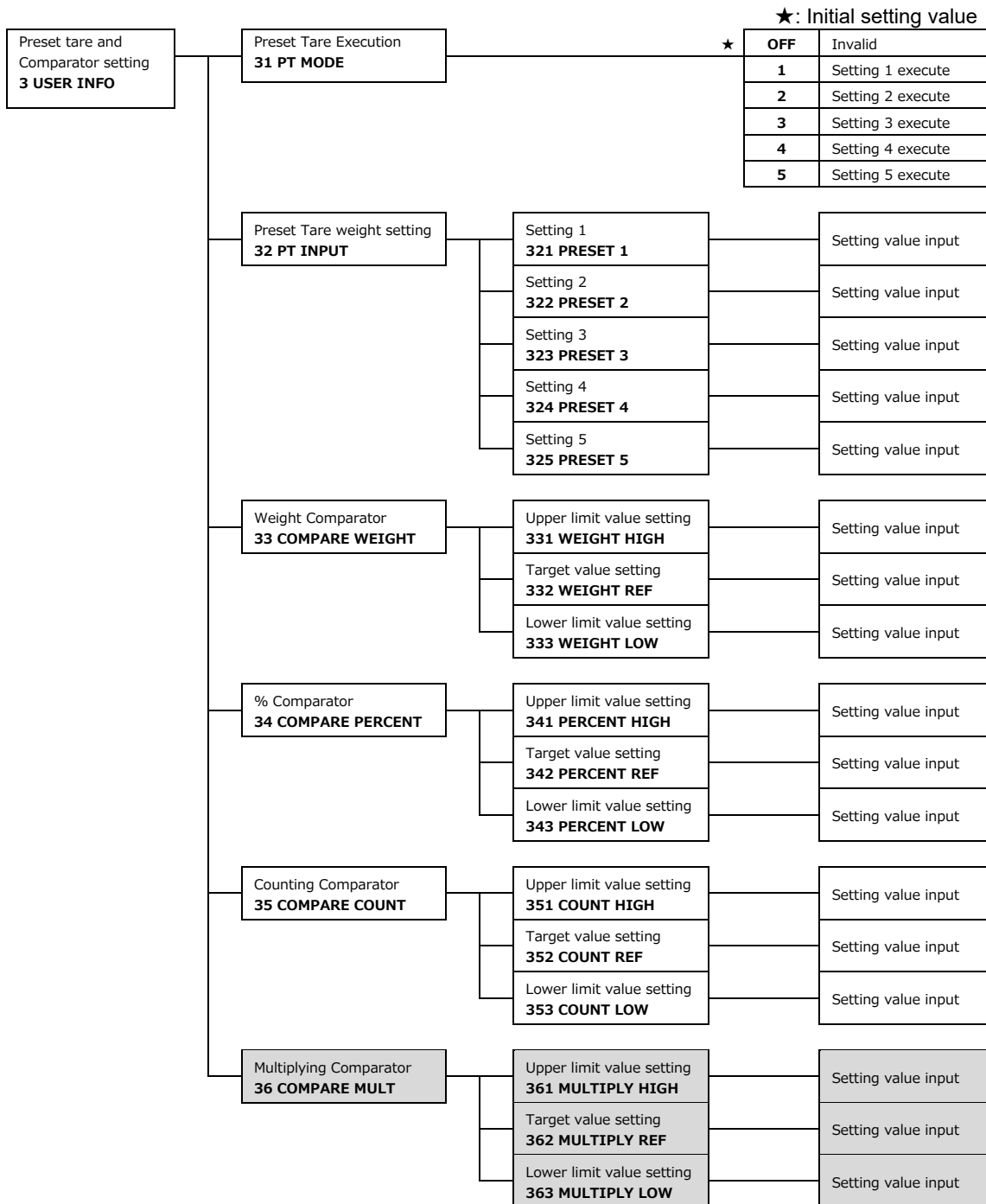

## 5-2 Preset tare

When using a tare whose weight is already known, the tare subtraction can be performed in advance by inputting its tare weight (preset tare weight). Five preset tare weight values can be registered.

### 5-2-1 Preset tare setting

**Reference** <31 PT MODE> is reset to <OFF> when the scale is turned off.

#### 1 Select the Preset tare setting.

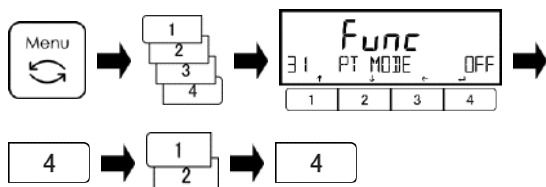

- Press [Menu] key, then press [1]-[4] keys to go to <31 PT MODE>.

- Press [4] key to change the setting value.

- Press [1] / [2] key to select.

Refer to Set List.

- Press [4] key to fix.

Set list		
OFF : Invalid	1 : Setting 1 execute	2 : Setting 2 execute
3 : Setting 3 execute	4 : Setting 4 execute	5 : Setting 5 execute

#### 2 Exit the setting menu.

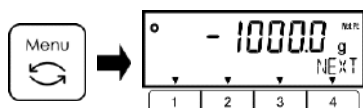

- Press [Menu] key to shift to the measuring mode.

Preset-tared weight is displayed with

< **Net Pt** > indication when preset tare weight value is available.

### 5-2-2 Inputting of a preset tare weight value

There are two ways of inputting a preset tare weight value described below:

- Actual value setting method: Weighing a sample with a scale and then making it a setting value.
- Numeric value setting method: Inputting a setting value directly via key operation.

#### 1 Select the preset tare weight setting.

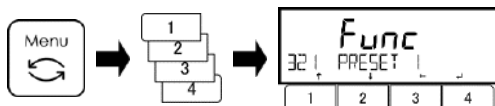

- Press [Menu] key, then press [1]-[4] keys to go to < 321 PRESET 1 >.

#### 2 Select the "Preset tare No."

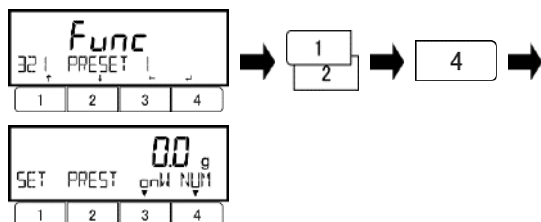

- Press [1]/[2] key to select the preset tare No.

321	PRESET	1
322	PRESET	2
323	PRESET	3
324	PRESET	4
325	PRESET	5

- Press [4] key to fix.

## 5-2-2 (1) Actual value setting method

### 1 Set a preset tare weight value.

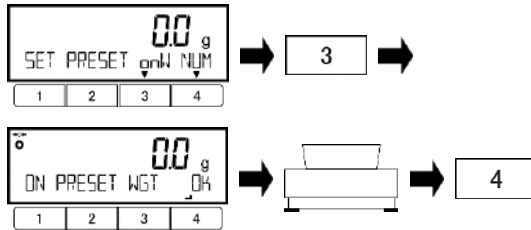

- Press [3] key to select.

onW : Actual value

- Place a sample to be weighed that is equivalent to the tare weight value.

- Press [4] key to fix.

- The preset tare weight value is stored.

### 2 Exit the setting menu.

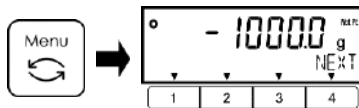

- Press [Menu] key to shift to the measuring mode.

## 5-2-2 (2) Numeric value setting method

### 1 Set a preset tare weight value.

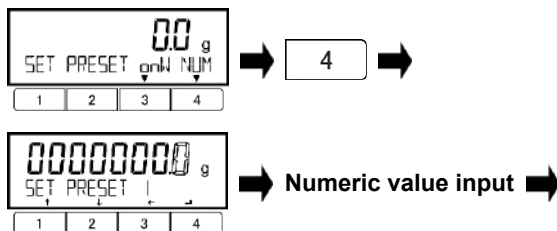

- Press [4] key to select.

NUM : Numeric value

- Input the preset tare value.

- Press [4] key to fix.

The preset tare weight value is stored.

4

(Refer to "2-5-3 Numeric value input")

### 2 Exit the setting menu.

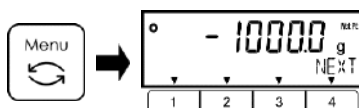

- Press [Menu] key to shift to the measuring mode.

## 5-2-2 (3) Exiting the preset tare mode

### 1 To exit the preset tare mode.

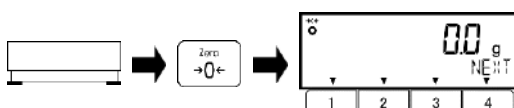

- Make sure that nothing is placed on the weighing pan.

- Press [Zero] key.

Then < Net Pt > disappears and the preset tare mode has exited.

### 5-3 Setting of the discrimination value of the comparator function

There are two ways of inputting a reference value and upper and lower limit values as described below:

- Actual value setting method: Weighing a sample with a scale and then making it a setting value.
- Numeric value setting method: Inputting a setting value directly via key operation.

The discrimination is performed according to the following criteria:

- Absolute value: The discrimination is performed based on the upper and lower limit values that have been set in advance.
- Relative value: A reference numeric value is set in advance, and the discrimination is performed based on the range defined by the upper and lower limit values that have been set for the reference numeric value.

(For example) Two-point (upper and lower limits) setting, Reference value = 1000.0g,  
Lower limit value = 900.0 g, Upper limit value = 1200.0 g

Discrimination method	Reference value	Lower limit value	Upper limit value
	1000.0 g	900.0 g	1200.0 g
Absolute value		900.0 g	1200.0 g
Relative value	1000.0 g	-100.0 g	200.0 g

#### 1 Select the “Actual value setting method” or “Numeric value setting method”.

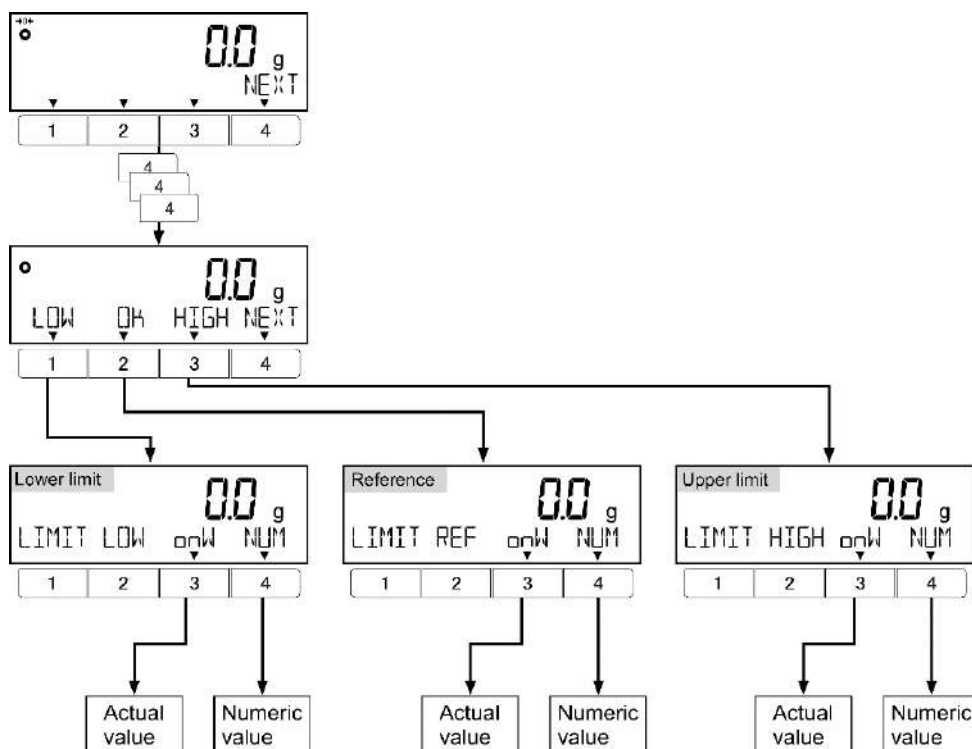

(1) Reference value, Lower limit value and Upper limit value can be set also via Setting menu below.

- Comparator setting for Weighing mode : 33 COMPARE WEIGHT
- Comparator setting for Percentage mode : 34 COMPARE PERCENT
- Comparator setting for Counting mode : 35 COMPARE COUNT
- Comparator setting for Multiplied by Coefficient mode: 36 COMPARE MULT

#### Reference

(2) Comparator function is available in Weighing mode, Percentage mode, Counting mode and Multiplied by Coefficient mode.

## 5-3-1 Actual value setting method

### 1 Set a lower limit value.

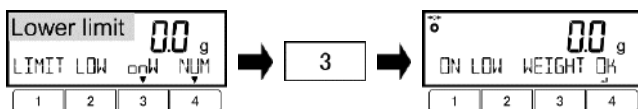

- Press [3] key to select.  
onW :Actual value
- Place a sample to be weighed that is equivalent to the lower limit value.
- Press [4] key to fix.  
The lower limit value is recorded.

### 2 Set a reference value.

(In the case of the relative value discrimination)

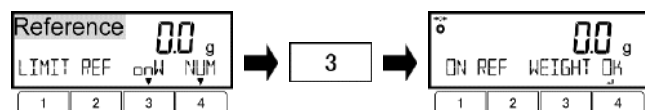

- Press [3] key to select.  
onW :Actual value
- Place a sample to be weighed that is equivalent to the reference limit value.
- Press [4] key to fix.  
The reference value is recorded.

### 3 Set an upper limit value.

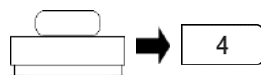
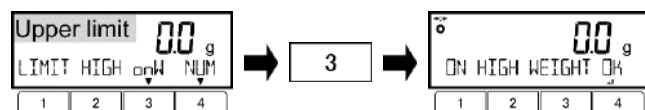

- Press [3] key to select.  
onW :Actual value
- Place a sample to be weighed that is equivalent to the upper limit value.
- Press [4] key to fix.  
The upper limit value is recorded.

## 5-3-2 Numeric value setting method

### 1 Set a lower limit value.

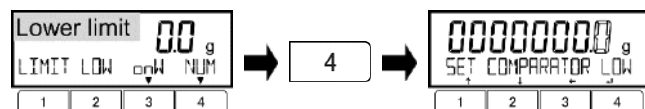

**Numeric value input** ➡ 4  
(Refer to "2-5-3 Numeric value input")

- Press [4] key to select.  
NUM :Numeric value
- Input the lower limit value.
- Press [4] key to fix.  
The lower limit value is saved.

### 2 Set a reference value.

(In the case of the relative value discrimination)



**Numeric value input** ➡ 4  
(Refer to "2-5-3 Numeric value input")

- Press [4] key to select.  
NUM :Numeric value
- Input the reference value.
- Press [4] key to fix.  
The reference value is saved.

### 3 Set an upper limit value.

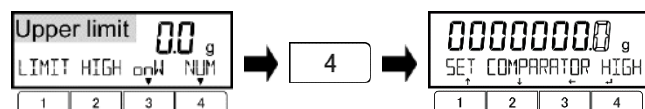

**Numeric value input** ➡ 4  
(Refer to "2-5-3 Numeric value input")

- Press [4] key to select.  
NUM :Numeric value
- Input the upper limit value.
- Press [4] key to fix.  
The upper limit value is saved.

# 6 External input/output functions

This function is used for communication with the external peripheral devices. As standard equipment, there are RS-232C (D-SUB 9P) and Serial output for peripherals (D-SUB 9P). The RS-232C is bidirectional and the Serial output for peripherals is for output only. The RS-232C and the Serial output for peripherals output the same signal. As factory option, Relay output can be added, or RS-422 output can be equipped instead of RS-232C, and please refer to the option manual for using each option.

## 6-1 Hierarchy of the external input / output functions



For verified scale:

- Grey-shaded items (  ) are not indicated;
- \*1 <412 FORMAT> is not indicated and fixed to <CBM>;
- \*2 <41A STATUS> is not indicated and fixed to <ON>.



- \*2 The initial setting value of <41A STATUS> is <OFF> on non-verified scale.

★: Initial setting value

External input/output functions 4 EXTERNAL I/O	RS232C/ Serial output/ optional RS422 41 RS232C	ON/OFF	★	OFF	OFF	
		411 ACTIVATE		ON	ON	
		*1	Communication format		6	6-digit numeric format
		412 FORMAT		7	7-digit numeric format	
				8	8-digit numeric format	
				CSP6	CSP 6-digit format	
				CSP7	CSP 7-digit format	
			*1 ★	CBM	CBM format	
			Output condition		OFF	Output stop
		413 CONDITION		1	Output continuously at all times	
				2	Output continuously when stable	
				3	Output once immediately after the [Output] key is pressed	
				4	Auto output	
				5	Output once when scale reached stable	
				6	Output continuously when unstable, then output once when scale reached stable	
			★	7	Output once when scale reached stable after the [Output] key is pressed	
			Comparator output setting	★	0	As per the output setting
		414 COMPARE		1	Output when discrimination result is OK or absent	
			Baud rate	★	1200	1200 bps
		415 BAUD RATE		2400	2400 bps	
		4800	4800 bps			
		9600	9600 bps			
		19200	19200 bps			
		38400	38400 bps			
		57600	57600 bps			
		115.2K	115200 bps			
	Parity	★	OFF	None		
416 PARITY		ODD	Odd number			
		EVEN	Even number			
	Stop bit	★	1BIT	1 bit		
417 STOP BIT		2BIT	2 bit			
	Unused high order digit	★	ZERO	Zero padding (0x30)		
418 BLANK		SPACE	Fill with spaces (0x20)			
	Response command	★	1	"A00, Exx" format		
419 RESPONSE		2	ACK, NAK format			
*2	Net value status	*2 ★	OFF	Not appended		
41A STATUS		*2 ★	ON	Appended		
	Time stamp	★	OFF	Not appended		
41B TIME STAMP		ON	Appended			

## 6-2 Connector terminal numbers, their functions and specifications

### 6-2-1 D-SUB9P Connector for RS232C I/O

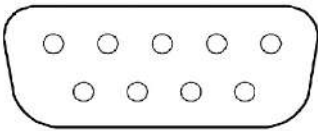
 <p>D-SUB9P male connector Cable fixing screw : No.4-40 UNC</p>	Terminal No.	Signal name	Input/output	Function
		1	—	—
	2	RXD	Input	Receiving data
	3	TXD	Output	Transmitting data
	4	DTR	Output	HIGH (When the scale is powered ON)
	5	GND	—	Signal grounding
	6	—	—	—
	7	—	—	—
	8	—	—	—
	9	EXT. TARE	Input	External contact input for tare subtraction

Items	Description
Transmission system	Serial transmission, Start-stop synchronisation, Bidirectional Equivalent to EIA RS-232C
Signal level	High level (data logic 0) +5 to +15 V Low level (data logic 1) -5 to -15 V
Baud rate	1200/2400/4800/9600/ 19200/38400/57600/115200 bps
Transmission code Composition	Start bit 1 bit Parity bit None/Odd number/Even number Data bit 8 bit Stop bit 1 bit/2 bit

**Note**

Use shielded crossover serial cable up to 15 m length.

- Use the following examples as a guide to connect the scale to external devices using the cable.

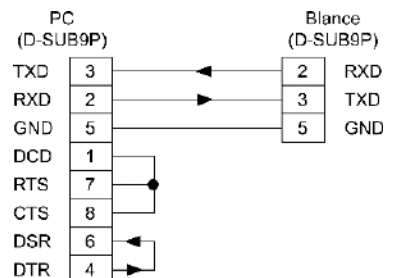

**Reference**

- Tare subtraction can be executed from an external device by connecting a contact or a transistor switch between the pin 1 (EXT.TARE) and pin 5 (GND).  
When doing so, allow at least 400 ms for connection (ON) time (Maximum voltage: 15 V when the scale is turned OFF, sink current: 20 mA when it is turned ON).

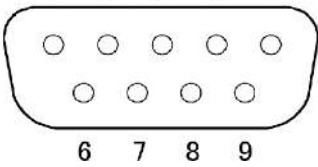

## 6-2-2 D-SUB9P Connector for serial output for peripherals

<p>D-SUB9P male connector Cable fixing screw : No.4-40 UNC</p> 	Terminal No.	Signal name	Input/output	Function
	1	—	—	—
	2	—	—	—
	3	TXD	Output	Transmitting data
	4	DTR	Output	HIGH (When the scale is powered ON)
	5	GND	—	Signal grounding
	6	—	—	—
	7	—	—	—
	8	—	—	—
	9	—	—	—

Items		Description
Transmission system		Serial transmission, Start-stop synchronisation, Unidirectional from the scale to peripherals
Signal level		High level (data logic 0) +5 to +15 V Low level (data logic 1) -5 to -15 V
Baud rate		1200/2400/4800/9600/ 19200/38400/57600/115200 bps
Transmission code Composition	Start bit Parity bit Data bit Stop bit	1 bit None/Odd number/Even number 8 bit 1 bit/2 bit

**Note**

Use shielded RS232 crossover cable up to 15 m length.

## 6-3 Communication format

### 6-3-1 Basic data output format / CSP format



These formats are not available for verified scale.

#### 1. Data composition

• Measurement result:

- 6-digit numeric format, CSP 6-digit format

Consists of 14 characters, including terminators (CR=0x0D, LF=0x0A).

1	2	3	4	5	6	7	8	9	10	11	12	13	14
P1	D1	D2	D3	D4	D5	D6	D7	U1	U2	S1	S2	CR	LF

- 7-digit numeric format, CSP 7-digit format

Consists of 15 characters, including terminators (CR=0x0D, LF=0x0A).

1	2	3	4	5	6	7	8	9	10	11	12	13	14	15
P1	D1	D2	D3	D4	D5	D6	D7	D8	U1	U2	S1	S2	CR	LF

- 8-digit numeric format

Consists of 16 characters, including terminators (CR=0x0D, LF=0x0A).

1	2	3	4	5	6	7	8	9	10	11	12	13	14	15	16
P1	D1	D2	D3	D4	D5	D6	D7	D8	D9	U1	U2	S1	S2	CR	LF

• Others (Date, Time etc.):

- 6-digit numeric format, 7-digit numeric format, 8-digit numeric format

The message "M1 M2 ... Mn" is suffixed with terminators (CR=0x0D, LF=0x0A).

1	2	...	n	n+1	n+2
M1	M2	...	Mn	CR	LF

- CSP 6-digit format, CSP 7-digit format

The message "M1 M2 ... Mn" is:

prefixed with device control code (DC2=0x12); and

suffixed with terminators (CR=0x0D, LF=0x0A) and device control code (DC4=0x14).

1	2	3	...	n+1	n+2	n+3	n+4
DC2	M1	M2	...	Mn	CR	LF	DC4

## 2. Meaning of the data

Symbol	Code	Description			
[P1] (one character) Indicates the polarity of data.					
+	0x2B	Zero or positive data			
-	0x2D	Negative data			
[D1 to D9/D10] (nine or ten characters) Stores numeric data.					
0 – 9	0x30 – 0x39	0 to 9 (numeric) 0 is also used for zero padding.			
.	0x2E	- Decimal point (floating)			
␣	0x20	- A space at the top of a numeric value - Output to the least significant digit in the absence of a decimal point - Unused high-order digit			
/	0x2F	Delimiter to be inserted to the left of the auxiliary-scale-interval place			
[U1, U2] (two characters) Indicates the unit used to show numeric data.					
␣	G	0x20	0x47	g	(gram)
K	G	0x4B	0x47	kg	(kilogram)
C	T	0x43	0x54	ct	(carat)
M	O	0x4D	0x4F	mom	(momme)
O	Z	0x4F	0x5A	oz	(ounce)
L	B	0x4C	0x42	lb	(pound)
O	T	0x4F	0x54	ozt	(troy ounce)
D	W	0x44	0x57	dwt	(pennyweight)
G	R	0x47	0x52	GN	(grain)
T	L	0x54	0x4C	tlH	(Hong Kong tael)
T	L	0x54	0x4C	tlS	(Singapore, Malaysia tael)
T	L	0x54	0x4C	tlT	(Taiwan tael)
T	o	0x74	0x6F	to	(tola)
M	S	0x4D	0x53	MSG	(mesghal)
B	A	0x42	0x41	BAt	(baht)
P	C	0x50	0x43	PCS	(parts counting)
␣	%	0x20	0x25	%	(percentage weighing)
␣	#	0x20	0x23	#	(Multiplied by Coefficient)
[S1] (one character) Indicates the judgment result when the limit function is used.					
L		0x4C		Shortage (LOW)	
G		0x47		Proper (OK)	
H		0x48		Over (HIGH)	
␣		0x20		No judgment result or data type specified	
e		0x65		Net weight	
f		0x66		Tare weight	
P		0x50		Preset tare weight	
T		0x54		Total value (Accumulated value)	
U		0x55		Unit weight	
d		0x64		Gross	
[S2] (one character) Indicates the status.					
S		0x53		Data stable	
U		0x55		Date unstable	
E		0x45		Data error (Indicates that data other than S2 is invalid and should be ignored.)	
␣		0x20		No status specified	

## 6-3-2 CBM data output format

### 1. Data composition

- Measurement result:

Composed of 26 characters including terminators (CR=0x0D, LF=0x0A)

1	2	3	4	5	6	7	8	9	10	11	12	13
S1	C1	┘	T1	T2	T3	T4	T5	T6	D1	D2	D3	D4
14	15	16	17	18	19	20	21	22	23	24	25	26
D5	D6	D7	D8	D9	D10	D11	D12	U1	U2	┘	CR	LF

- Error message:

Composed of 26 characters including terminators (CR=0x0D, LF=0x0A)

1	2	3	4	5	6	7	8	9	10	11	12	13
*	*	┘	E	R	R	O	R	┘	*	*	*	*
14	15	16	17	18	19	20	21	22	23	24	25	26
*	*	*	*	*	*	*	*	*	*	┘	CR	LF

- Others (Date, Time etc.):

The message "M1 M2 ... Mn" is suffixed with terminators (CR=0x0D, LF=0x0A).

1	2	...	n	n+1	n+2
M1	M2	...	Mn	CR	LF

### 2. Meaning of the data

Symbol	Code	Description	
<b>[S1] (1 character) Represents the status.</b>			
┘	0x20	Data stable	
*	0x2A	Data unstable	
<b>[C1] (1 character) Represents the result of comparator function.</b>			
┘	0x20	Comparator result: Proper (OK) or No result	
H	0x48		Over (HIGH)
L	0x4C		Shortage (LOW)
<b>[T1-T6] (6 characters) Represents the type of the data.</b>			
(SP) (SP) (SP) (SP) (SP) (SP)	0x20 0x20 0x20 0x20 0x20 0x20	Net weight (<41A STATUS>: <OFF>)	
N (SP) (SP) (SP) (SP) (SP) (SP)	0x4E 0x20 0x20 0x20 0x20 0x20	Net weight (<41A STATUS>: <ON>)	
P T (SP) (SP) (SP) (SP) (SP) (SP)	0x50 0x54 0x20 0x20 0x20 0x20	Preset tare weight	
T (SP) (SP) (SP) (SP) (SP) (SP)	0x54 0x20 0x20 0x20 0x20 0x20	Tare weight	
T O T A L (SP) (SP) (SP) (SP) (SP) (SP)	0x54 0x4F 0x54 0x41 0x4C 0x20	Total value (Accumulated value)	
G (SP) (SP) (SP) (SP) (SP) (SP)	0x47 0x20 0x20 0x20 0x20 0x20	Gross weight	
U N I T (SP) (SP) (SP) (SP) (SP) (SP)	0x55 0x4E 0x49 0x54 0x20 0x20	Unit weight	
<b>[D1-D12] (12 characters) Numeric value data is stored.</b>			
+	0x2B	Zero or positive data	
-	0x2D	Negative data	
0 – 9	0x30 – 0x39	0 to 9 (numeric) 0 is also used for zero padding.	
.	0x2E	Decimal point (floating decimal point)	
[	0x5B	The number surrounded by '[' and ']' means auxiliary indication	
]	0x5D		
┘	0x20	- Spaces fill the top of the data. - Output to the least significant digit in the absence of a decimal point - Unused high-order digit	
<b>[U1, U2] (2 characters) Represents the unit of numeric value data.</b>			
┘	g	0x20 0x67	gram
k	g	0x6B 0x67	kilogram
c	t	0x63 0x74	carat
m	o	0x6D 0x6F	momme
o	z	0x6F 0x7A	ounce
l	b	0x6C 0x62	pound
O	T	0x4F 0x54	troy ounce
d	w	0x64 0x77	pennyweight
t	l	0x74 0x6C	Hong Kong tael
t	l	0x74 0x6C	Singapore, Malaysia tael
t	l	0x74 0x6C	Taiwan tael
t	o	0x74 0x6f	tola
P	C	0x50 0x43	parts counting
┘	%	0x20 0x25	% (percentage weighing)
┘	#	0x20 0x23	# (Multiplied by Coefficient)

## 6-4 Input command

### Note

Commands input during the scale being busy (function setting, zero-point adjustment, tare subtraction etc.) are not accepted.

### Reference

Inputting command is available only through RS232C I/O.

### 6-4-1 Transmission procedure

## 1

Send an input command from an external device to the scale.

The table below shows the enable/disable of input commands in each measuring mode.

Commands			
Measuring mode	Zero-point adjustment, Tare subtraction, Date/Time output	Output control, Comparator setting, Preset tare setting, Interval time setting	External contact input
Weighing	X	X	X
Counting	X	X	X
Percentage	X	X	X
Multiply	X	X	X

## 2

Upon successful completion of an input command, the scale will send either a normal completion response or the result data requested by the command to the external device.

- If the operation has not resulted in successful completion, or if the command is invalid (an error), the scale will transmit an error response.
- When the scale is in normal display mode, it usually sends a response to a command within one second of receiving the command. For the tare subtraction and zero-point adjustment, a response is sent after the commands are completely processed.

### Note

- (1) After you have sent an input command, the scale return the response command approximately in 1 second.
- (2) Do not send another command to the scale until the external device receives a response from the scale.
- (3) If the scale receives a command when you are setting a function, when the scale is under span adjustment, or the scale is busy for other reasons, the command is ignored.

### Reference

In the case that <17 WT STABLE> is <ON>, the scale waits the weighing stability after receiving Tare-subtraction command/Zero-point adjustment command, so the scale may need additional response time.



For verified scale, <17 WT STABLE> is fixed to <ON> and the scale always waits the weighing stability after receiving such a command.

## 6-4-2 Input command composition 1

Composed of four characters including a terminator (CR=0x0D, LF=0x0A).

1	2	3	4
C1	C2	CR	LF

### 6-4-2 (1) Zero-point adjustment/Tare/Output control setting command

**Note**

Please take care not to take alphabetical "O" for Arabic number "0".

C1	C2	Code (C1)	Code (C2)	Description	Response			
					A00/Exx format	ACK/NAK format		
T	┘	0x54	0x20	Zero-point adjustment/Tare subtraction	A00: Normal response	ACK: Normal response		
Z	┘	0x5a	0x20	Zero-point adjustment				
O	0	0x4f	0x30	Stop output.				
O	1	0x4f	0x31	Continuous output at all times				
O	2	0x4f	0x32	Continuous output at stable times (Output stop at unstable times)				
O	3	0x4f	0x33	Press down [Output] key for one-time instant output.				
O	4	0x4f	0x34	Auto output				
O	5	0x4f	0x35	One-time output at stable times (Output stop at unstable times)				
O	6	0x4f	0x36	One-time output at stable times (Continuous output at unstable times)				
O	7	0x4f	0x37	Press down [Output] key for one-time output at stable times.			E01: Abnormal response	NAK: Abnormal response
O	8	0x4f	0x38	One-time instant output				
O	9	0x4f	0x39	One-time output after stability is obtained				
O	A	0x4f	0x41	Interval function (Output once each time the output time has elapsed)				
O	B	0x4f	0x42	Interval function (Output once during stabilization, each time the output time has elapsed)				

(1) Commands O8 and O9 are used to request data from the scale.

(2) Once the O0 to O7 commands are executed, the output control setting is maintained until the scale is turned off.

When [Menu] key is pressed or the scale is turned on again, the output control setting is reset to the < 413 CONDITION > setting.

(3) When the OA or OB command is input, the interval function starts, and when input again, the interval function ends.

(4) After the O8 or O9 command is executed, it returns to "O0."

**Reference**

### 6-4-2 (2) Date output request and time output request

C1	C2	Code (C1)	Code (C2)	Description	Response
D	D	0x44	0x44	Date output request	Date data
D	T	0x44	0x54	Time output request	Time data

### 6-4-2 (3) Span adjustment/test command



The command "C4" is not accepted on verified scale.

C1	C2	Code (C1)	Code (C2)	Description	Response	
					A00/Exx format	ACK/NAK format
C	1	0x43	0x31	Execute semi-automatic span adjustment with internal weight	A00: Normal response E01: Abnormal response	ACK: Normal response NAK: Abnormal response
C	2	0x43	0x32	Execute span test with internal weight		
C	3	0x43	0x33	Execute span adjustment with internal weight		
C	4	0x43	0x34	Execute span test with internal weight		

### 6-4-3 Input command composition 2

Composed of 15 characters including a terminator (CR=0x0D/LF=0x0A)

1 2 3 4 5 6 7 8 9 10 11 12 13 14 15

C1	C2	,	C3	C3	C3	C3	C3	C3	C3	C3	C3	C3	CR	LF
----	----	---	----	----	----	----	----	----	----	----	----	----	----	----

(1) 'C3' is maximum ten-digit (including the polarity +/-, comma and point) numeric data.

Example) Upper limit input 120.0000g: "LA,120.0000"

Preset tare input 100.0000g: "PT,100.0000"

Interval time input 12:34:56: "IA,12,34,56" (marked off by commas)

**Reference**

(2) Make sure not input the measuring unit (mg, g, ct, etc.).

(3) Input the command when Weighing mode, Percentage mode, Counting mode or Multiplied by Coefficient mode is operating.

If it is input while the other mode operation, the scale output an abnormal response.

(4) If the input value is invalid, the scale output an abnormal response.

### 6-4-3 (1) Comparator setting command

C1	C2	Code (C1)	Code (C2)	Description	C3	Response	
						A00/Exx format	ACK/NAK format
L	A	0x4C	0x41	Lower limit value setting	Numeric value setting	A00: Normal response E01: Abnormal response	ACK: Normal response NAK: Abnormal response
L	B	0x4C	0x42	Upper limit value setting	Numeric value setting		
L	C	0x4C	0x43	Reference value setting	Numeric value setting		

### 6-4-3 (2) Preset tare value setting command

C1	C2	Code (C1)	Code (C2)	Description	C3	Response	
						A00/Exx format	A00/Exx format
P	T	0x50	0x54	Preset tare value setting	Numeric value setting	A00: Normal response E01: Abnormal response	ACK: Normal response NAK: Abnormal response

**Reference**

(1) When the normal response, the preset tare value is input in <321 PRESET 1> and the scale operates Preset tare.

(2) If the input value is "0" at Preset tare setting value command, the preset tare operation is cancelled.

### 6-4-3 (3) Interval (output) time setting command

C1	C2	Code (C1)	Code (C2)	Description	C3	Response	
						A00/Exx format	A00/Exx format
I	A	0x49	0x41	Interval (output) time setting	Numeric Value setting	A00: Normal response E01: Abnormal response	ACK: Normal response NAK: Abnormal response

## 6-5 Response

### 6-5-1 Response command format (A00/Exx format)

Consists of five characters including terminators.

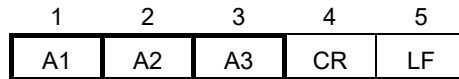

#### 6-5-1(1) Response command

A1	A2	A3	code(A1)	code(A2)	code(A3)	Description
A	0	0	0x41	0x30	0x30	Normal response
E	0	1	0x45	0x30	0x31	Abnormal response

### 6-5-2 Response command format (ACK/NAK format)

Consists of one character without a terminator.



#### 6-5-2(1) Response command

A1	code(A1)	Description
ACK	0x06	Normal response
NAK	0x15	Abnormal response

## 6-6 Communication setting

For verified scale:



- Setting menu <412 FORMAT> is not available. That is fixed to <CBM> (CBM format) and other formats are not available;
- Output conditions <413 CONDITION 1, 3, 6> are not available;
- Setting menus <41A STATUS> is not available. That is fixed to <ON> and the net value status is always appended.

**1**

Select the RS-232C communication operation.

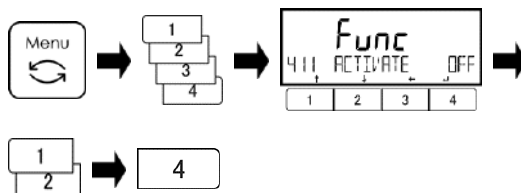

- Press [Menu] key, then press [1]-[4] keys to go to <411 ACTIVATE>.

- Press [4] key to change the setting value.

- Press [1]/[2] key to select.

OFF: Stop

ON: Operation

- Press [4] key to fix.

# 2

## Select the communication setting.

Refer to the step 1 to key operation for setting.

<b>Select the communication condition.</b>		
412 FORMAT		
Set list		
6 : 6-digit numeric format	7 : 7-digit numeric format	8 : 8-digit numeric format
CSP6 : CSP 6-digit format	CSP7 : CSP 7-digit format	CBM : CBM format
<b>Select the output conditions.</b>		
413 CONDITION		
Set list		
0 : Output stop	1 : Continuous output at all times	2 : Continuous output at stable times (Output stop at unstable times)
3 : One-time output immediately after [Output] key is pressed	4 : Auto output (One-time output when the scale is loaded and stabilised. The next output for another sample loading is executed once the indication becomes stabilised at less than or equal to zero by unloading, zero-point adjustment or tare-subtraction.)	5 : One-time output every time when the scale reaches stable (Output stop at unstable times)
6 : Continuous output at unstable times and one-time output every time when the scale reaches stable	7 : One-time output after [Output] key is pressed and the scale reaches stable	
<b>Select the comparator output.</b>		
414 COMPARE		
Set list		
0 : As per the output setting	1 : Output when discrimination result is OK or absent	
<b>Select the baud rate.</b>		
415 BAUD RATE		
Set list		
1200 : 1200 bps	2400 : 2400 bps	4800 : 4800 bps
9600 : 9600 bps	19200 : 19200 bps	38400 : 38400 bps
57600 : 57600 bps	115.2 k : 115200 bps	
<b>Select the parity bit.</b>		
416 PARITY		
Set list		
OFF : None	ODD : Odd number	EVEN : Even number
<b>Select the stop bit.</b>		
417 STOP BIT		
Set list		
1BIT : 1 bit	2BIT : 2 bit	
<b>Select unused high order digit.</b>		
418 BLANK		
Set list		
ZERO : Filled with 0 (0x30)	SPACE : Filled with a blank space (0x20)	
<b>Select the response command format.</b>		
419 RESPONSE		
Set list		
1 : "A00/Exx" format	2 : "ACK/NAK" format	
<b>Select the net value status.</b>		
41A STATUS		
Set list		
OFF : Not appended	ON : Appended	
<b>Select the time stamp setting.</b>		
41B TIME STAMP		
Set list		
OFF : Not appended	ON : Appended	



# 7 Functions related to the lock

Impose limitations on key operation and accessing the menu items, etc.

## 7-1 Hierarchy of functions related to the lock

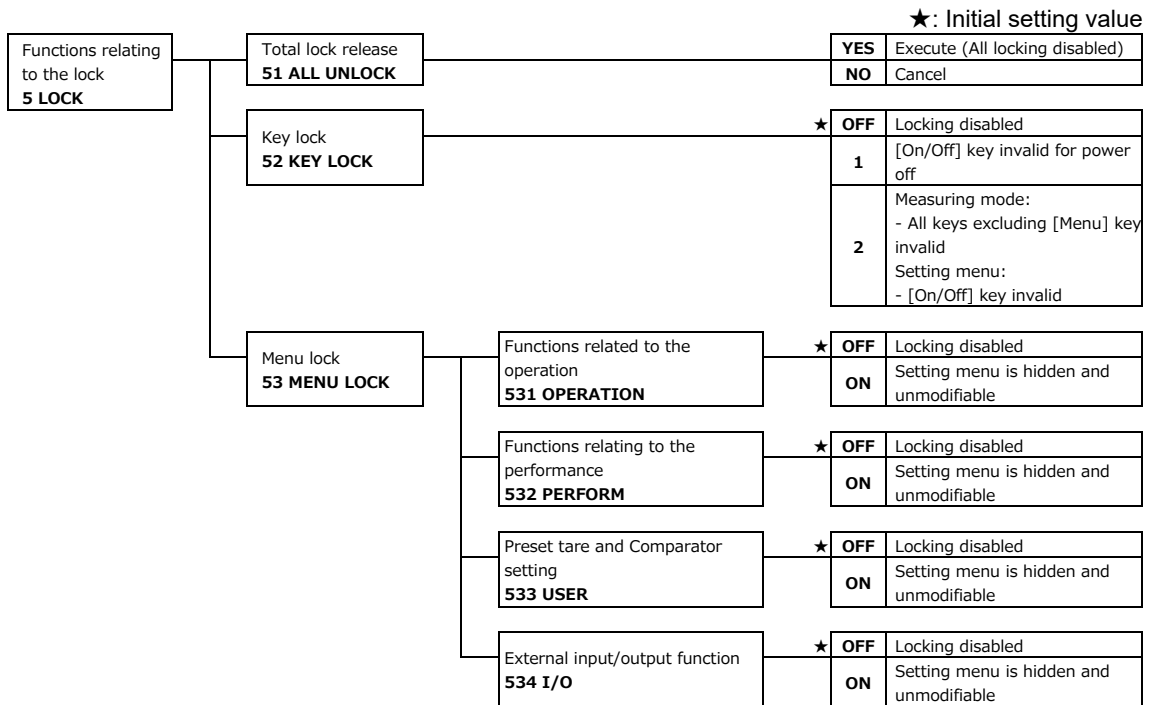

## 7-2 Total lock release

All locks that have been set can be released.

### 1 Select the total lock release.

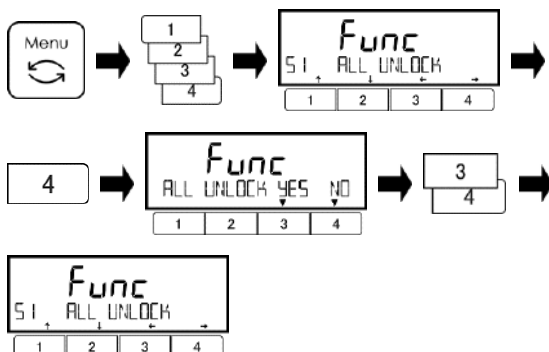

- Press [Menu] key, then press [1]-[4] keys to go to <51 ALL UNLOCK>.
- Press [4] key.
- Press [3]/[4] key to select.

YES: Execute  
NO: NO execute

All the settings unlocked.

### 2 Exit the setting menu.

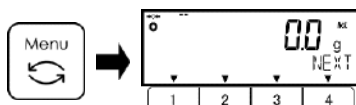

- Press [Menu] key to shift to the measuring mode.

## 7-3 Key lock function

Key operation can be locked.

### 1 Select the key lock function.

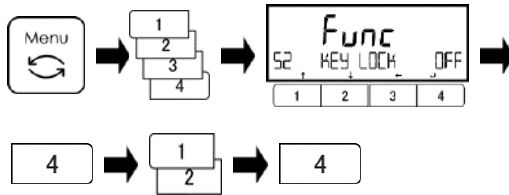

- Press [Menu] key, then press [1]-[4] keys to go to <52 KEY LOCK>.

- Press [4] key to change the setting value.

- Press [1]/[2] key to select.

OFF: No restriction

1: [On/Off] key invalid for power off

Measuring indication:

All keys excluding [Menu] key invalid

2: Setting menu:

[On/Off] key invalid

- Press [4] key to fix.

### 2 Exit the setting menu.

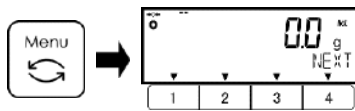

- Press [Menu] key to shift to the measuring mode.

## 7-4 Menu lock function

Various setting menus can be locked.

### 1 Select the menu lock function.

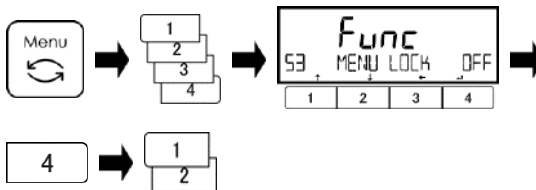

- Press [Menu] key, then press [1]-[4] keys to go to <53 MENU LOCK>.

- Press [4] key to change.

- Press [1]/[2] key to select.

Refer to Set List.

Set list	
531 : Function related to the operation OPERATION <1 APPLICATIONS>	532 : unction related to the performance PERFORM <2 PERFORMANCE>
533 : Preset tare and comparator setting USER <3 USER INFO>	534 : External input/output functions I/O <4 EXTERNAL I/O>

### 2 Select modifiable/unmodifiable of each menu.

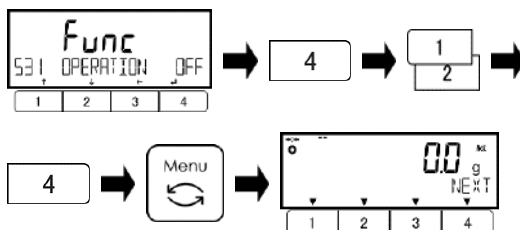

- Press [4] key to change the setting value.

- Press [1]/[2] key to select.

OFF: Modifiable

ON: Unmodifiable

- Press [4] key to fix.

- Press [Menu] key to shift to the measuring mode.

# 8 Controlling and adjustment functions

Perform setting of the scale ID, the span adjustment/test and the date and time.

## 8-1 Hierarchy of controlling and adjustment functions

- \*1 For non-verified scale, the initial setting value of <621 F1 KEY> is:  
 - <CAL> for model without internal calibration weight;  
 - <ICAL> for model with internal calibration weight.
- \*2 The initial setting value of <625 F5 KEY> is:  
 - <OFF> for double-range model (HJ62K0.1DS(R));  
 - <READ> for other models.
- Reference** \*3 <ICAL > of <61\* F\* KEY>, <633 INT CAL>, <634 INT SPAN TEST>, <635 ARM>, <636 REF CAL>, <637 REF CAL RESTORE>, <638 ADVICE CAL> and <64B START CAL> are available only on the models with internal calibration weight.
- \*4 <64A READABILIT> is not available on double-range model (HJ62K0.1DS(R)).
- \*5 <644 SET USER PASS> appears only when you log in in administrator mode with <642 PASSWORD> set to <ON>.

- For verified scale, grey-shaded items (  ) are not indicated.

- Legal Metrology** \*6 Initial setting value of <621 F1 KEY> is:  
 - <OFF> for model without internal calibration weight;  
 - <ICAL> for model with internal calibration weight.

★: Initial setting value

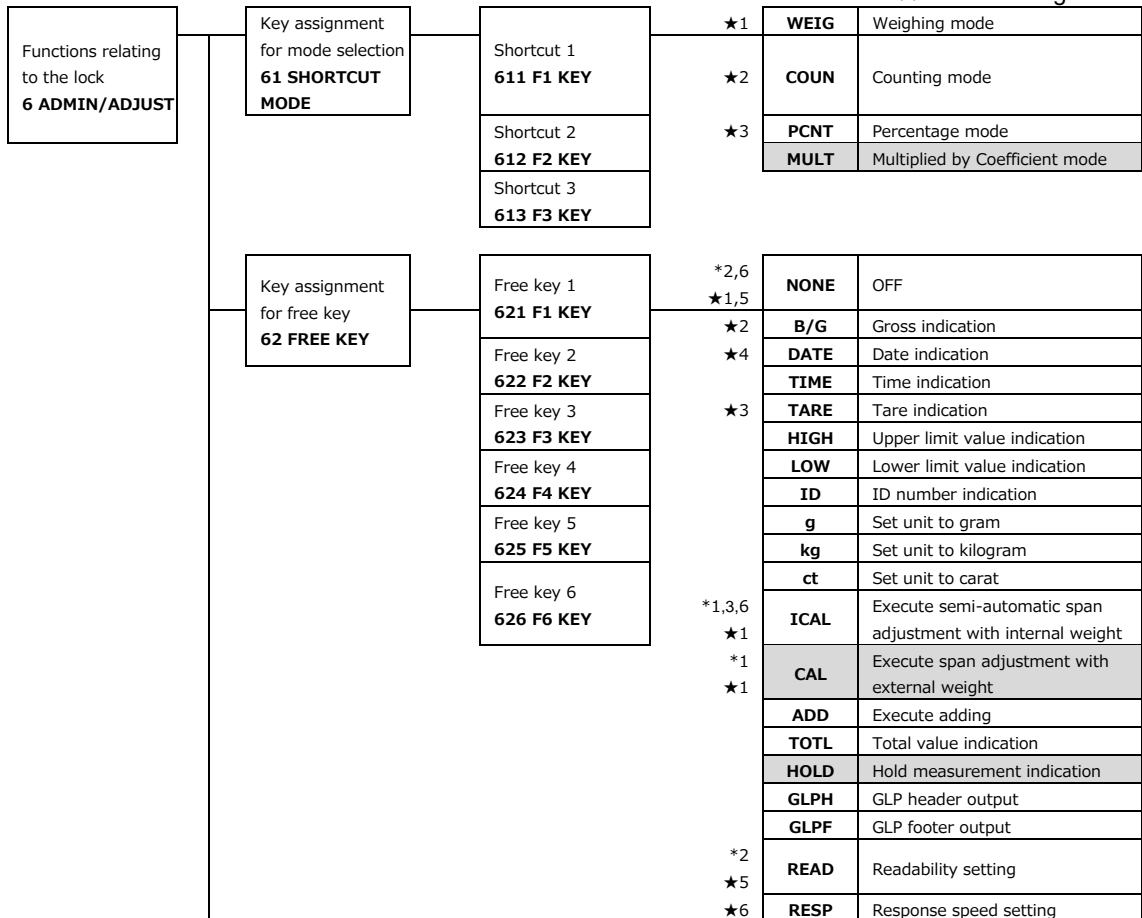

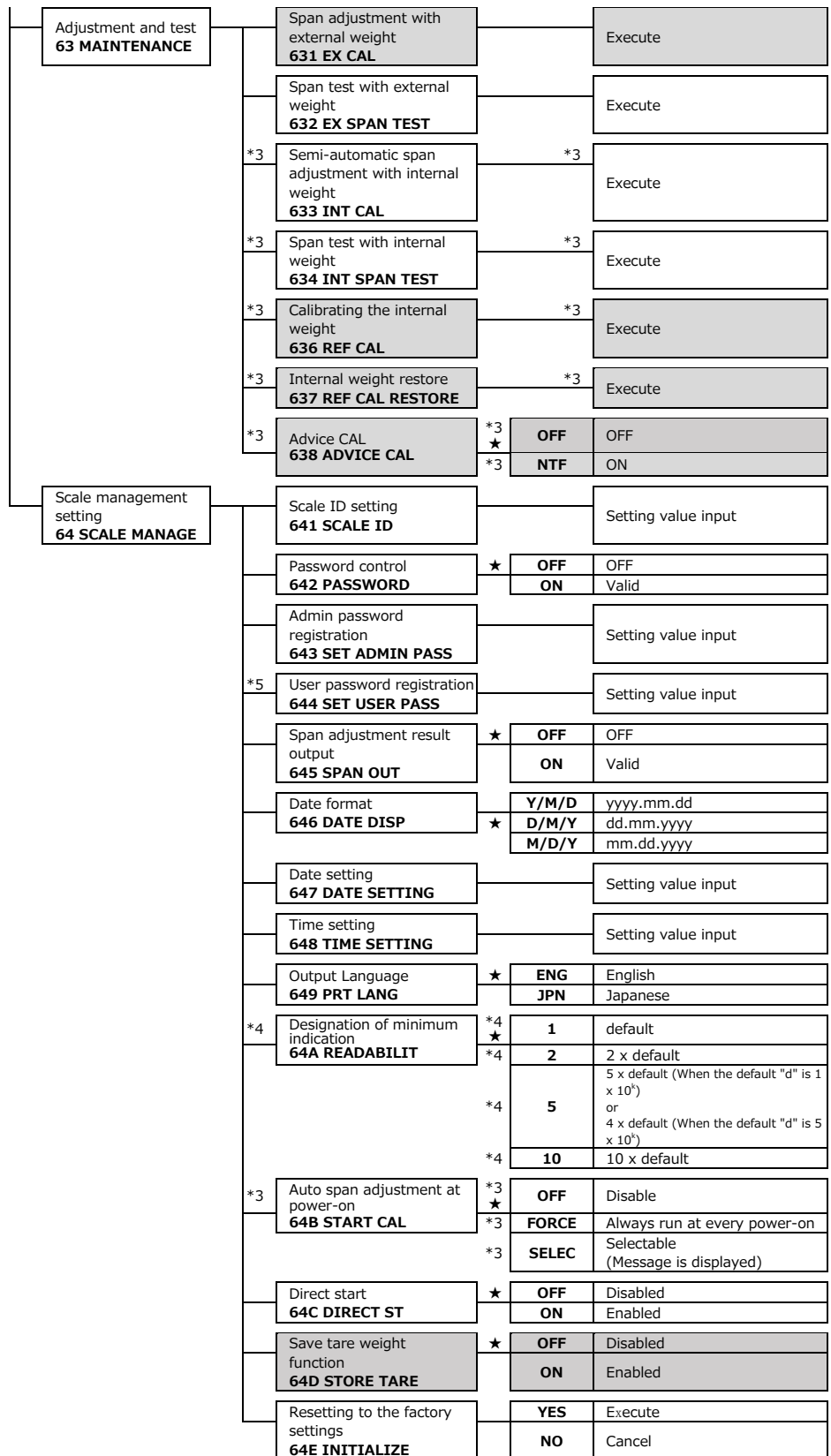

## 8-2 Shortcut setting for accessing various measuring modes

Shortcuts for various measuring mode can be assigned to <<F1>>, <<F2>>, <<F3>> which are displayed above [1], [2], [3] key.

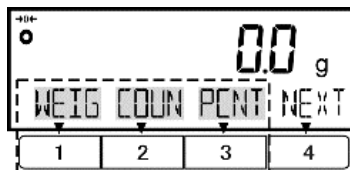

For verified scale, only Weighing mode <WEIG>, Counting mode <COUN> and Percentage mode <PCNT> can be selected. Multiplied by Coefficient mode <MULT> cannot be selected.

### 1 Select <<F1-F3>>.

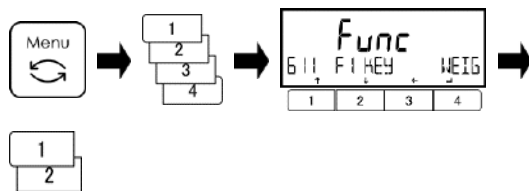

- Press [Menu] key, then press [1]-[4] keys to go to <611 F1 KEY>.

- Press [4] key to change.

- Press [1]/[2] key to select.

611 F1 KEY: <<F1>> above [1] key

612 F2 KEY: <<F2>> above [2] key

613 F3 KEY: <<F3>> above [3] key

### 2 Select the measuring modes.

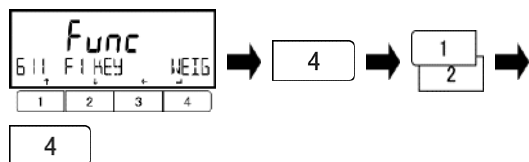

- Press [4] key to change the setting value.

- Press [1]/[2] key to select.

Refer to Set List.

- Press [4] key to fix.

Set list

WEIG : Weighing mode	COUN : Counting mode	PCNT : Percentage mode
MULT : Multiplied by Coefficient mode		

### 3 Exit the setting menu.

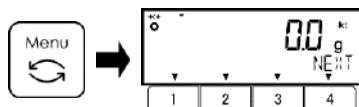

- Press [Menu] key to shift to the measuring mode.

### 4 Use shortcut

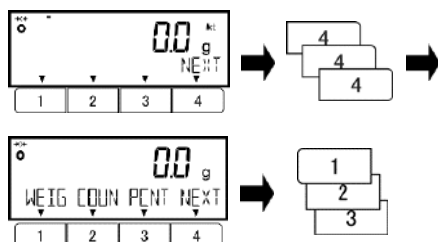

- Press [4] key several times to shift to the shortcut display.

- Press [1], [2] or [3] key to shift to each measuring mode.

## 8-3 Free key setting

### Reference

- (1) Free key setting is valid only in the weighing mode.
- (2) <ICAL>, <GLPH> and <GLPF> are available only on the models with internal calibration weight.
- (3) <READ> is not available on HJ62K0.1DS(R).

Legal  
Metrology

<CAL> and <HOLD> are unavailable for verified scale.

Various function can be assigned to the <<F1-F6>> (Free key), which are displayed above the [1]-[3] keys.

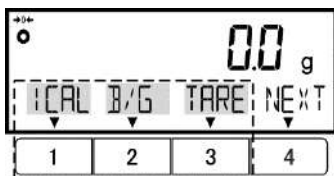

Display1 (<<F1-F3>>)

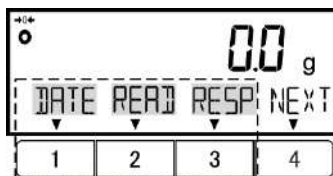
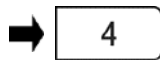

Display2 (<<F4-F6>>)

### 1 Select each Free key setting menu.

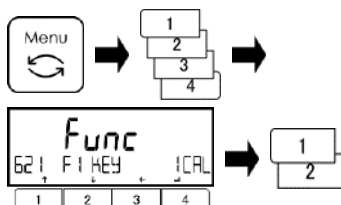

- Press [Menu] key, then press [1]-[4] keys to go to <621 F1 KEY>.

- Press [1]/[2] key to select each Free key setting menu.

Refer to "Free key setting menu list".

Free key setting menu list		
621 F1 KEY : <<F1>>	622 F2 KEY : <<F2>>	623 F3 KEY : <<F3>>
624 F4 KEY : <<F4>>	625 F5 KEY : <<F5>>	626 F6 KEY : <<F6>>

### 2 Select the function to assign to the Free key.

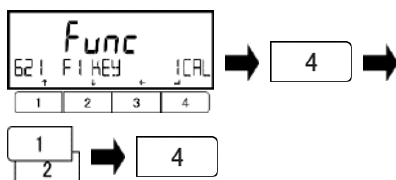

- Press [4] key to change the setting value.

- Press [1]/[2] key to select.

Refer to Set List.

- Press [4] key to fix.

Set list	
NONE : OFF	B/G : Gross indication
DATE : Date indication	TIME : Time indication
TARE : Tare value indication	HIGH : Upper limit value indication
LOW : Lower limit value indication	ID : ID number indication
g : Unit set "gram"	kg : Unit set "kilogram"
ct : Unit set "carat"	ICAL : Semi-automatic span adjustment with internal weight
CAL : Span adjustment with external weight	ADD : Adding execute
TOTL : Total indication	HOLD : Measurement indication hold
GLPH : GLP header output	GLPF : GLP footer output
READ : Readability setting	RESP : Response speed setting

### 3 Exit the setting menu.

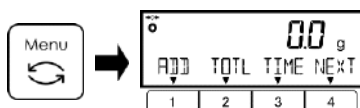

- Press [Menu] key to shift to the weighing mode.

## 8-4 Adjustment and test

### 8-4-1 Span adjustment and span test

Span adjustment is to “decrease” the difference between an indicated value and the true value (mass), and span test is to “check” the difference between an indicated value and the true value. This must be performed without fail in the case of doing high-accuracy weighing work. Because an electronic scale is affected by the acceleration of gravity, adjustment/test is needed at every weighing location. The adjustment/test is also needed when (1) using a long period and (2) an accurate indication does not appear any longer. When “Advice CAL” is activated, the scale generates an alarm when calibration is needed.

#### Note

- (1) An external weight used for the span adjustment shall be the one equivalent to:
  - OIML class F1 or higher for models with capacity of 33 kg and 62 kg;
  - OIML class F2 or higher for models with capacity 17 kg and 22 kg.
- (2) The span adjustment significantly affects the weighing accuracy. Please read this procedure carefully before getting to the adjustment.

### 8-4-1(1) Span adjustment with external weight



This function is unavailable for verified scale.

#### Reference

Free key <<CAL>> (span adjustment with external weight) is assigned to <<F1>> on the models without internal calibration weight.

#### 1 Select the span adjustment with external weight.

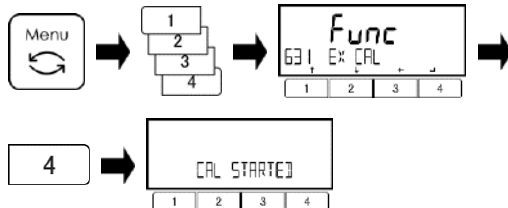

- Press [Menu] key, then press [1]-[4] keys to go to <631 EX CAL>.
- Press [4] key to execute.

#### 2 For HJ17K0.1S(R), HJ22K0.1S(R) and HJ33K0.1S(R): Select the minimum interval for rounding the weight of the external weight.

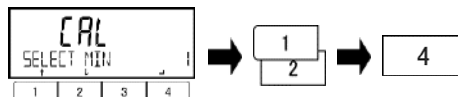

- Press [1]/[2] key to select
  - 1: 0.1 g
  - 2: 0.2 g
  - 5: 0.5 g
  - 10: 1 g
- Press [4] key to fix.
- \* This step is skipped for HJ62K0.1DS(R).

#### 3 Select a weight used for the span adjustment.

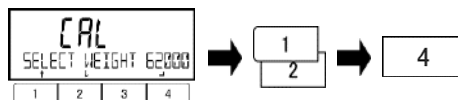

- Press [1]/[2] key and select a weight used for the span adjustment. (Refer to List of “weights used for the span adjustment by model”)
- Press [4] key to fix.

#### 4 Zero-point adjustment starts.

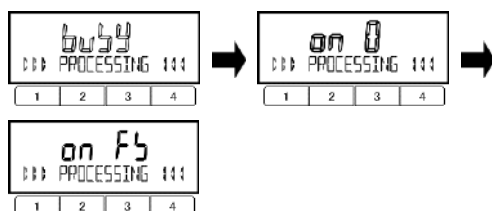

Display changes to the order of “blinking of <buSy>” → “blinking of <on 0>”. On completion of the zero-point adjustment, the display automatically changes to <on FS>.

## 5 The span adjustment starts.

For HJ17K0.1S(R) and HJ22K0.1S(R):

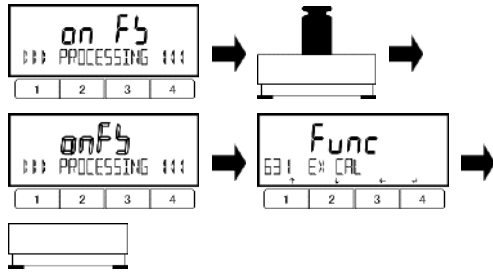

- Place the weight in the centre of the weighing pan.

- For HJ17K0.1S(R) and J22K0.1S(R):  
Display changes to the order of <on FS> → “blinking of <on FS>”.  
Then span adjustment starts.

For HJ33K0.1S(R), and HJ62K0.1DS(R):

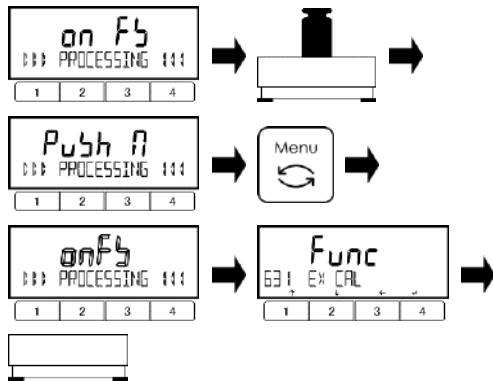

- For HJ33K0.1S(R), HJ62K0.1DS(R):  
Display changes to the order of <on FS> → <push M>.  
- Press [Menu] key.  
Display changes to “blinking of <on FS>”, then span adjustment starts.

On completion of the span adjustment, the display automatically changes to <631 EX CAL>.

- Unload the weight from the weighing pan.

## 6 Exit the setting menu.

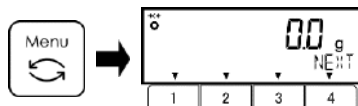

- Press [Menu] key to shift to the measuring mode.

(1) List of weights used for the span adjustment by model (Unit: g).

Model	HJ17K0.1S(R)	HJ22K0.1S(R)	HJ33K0.1S(R)	HJ62K0.1DS(R)
Selectable weight on the menu	17000	22000	33000	62000
VAR set	1 - 17000	1 - 22000	1 - 33000	1 - 62000

### Reference

(2) The span adjustment by the use of a weight less than the weighing capacity may possibly indicate <UC> on the display. When this is the case, the weighing accuracy is not guaranteed.

Conditions under which <UC> is indicated;

- When a sample that is more than two times heavier than the weight that was used for the span adjustment is weighed, and
- When the readability (minimum indication) setting <64A READABILIT>, which is finer than the minimum interval for rounding setting <SELECT MIN> selected for the span adjustment, is performed.

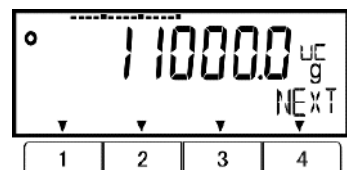



## 8-4-1(2) Span test with external weight

**Note**

Make sure to use the external weight which is equal to the weighing capacity of each model.

### 1 Select the span test with external weight.

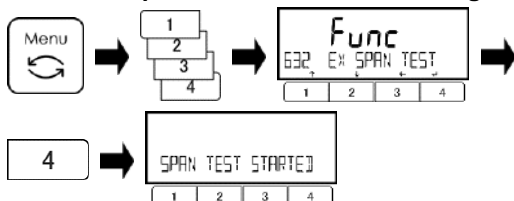

- Press [Menu] key, then press [1]-[4] keys to go to <632 EX SPAN TEST>.

- Press [4] key to execute.

### 2 Zero-point adjustment starts.

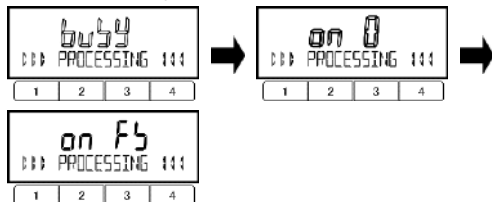

Display changes to the order of "blinking of <buSY>" → "blinking of <on 0>".

On completion of the zero-point adjustment, the display automatically changes to <on FS>.

### 3 The span test starts.

For HJ17K0.1S(R) and HJ22K0.1S(R):

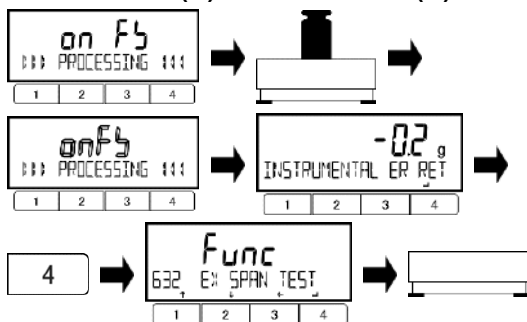

- Place the weight in the centre of the weighing pan.

• For HJ17K0.1S(R) and HJ22K0.1S(R):

Display changes to the order of <on FS> → "blinking of <on FS>". Then span test starts.

For HJ33K0.1S(R), and HJ62K0.1DS(R):

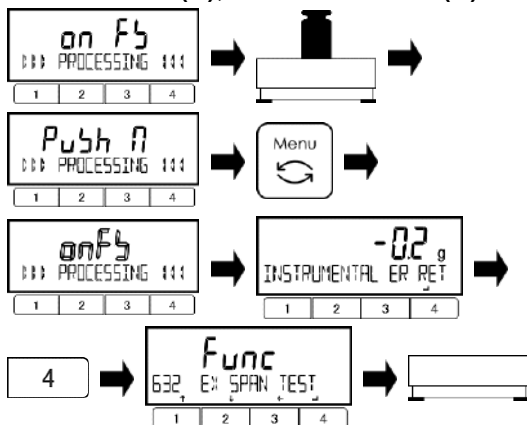

• For HJ33K0.1S(R), and HJ62K0.1DS(R):

Display changes to the order of <on FS> → <push M>.

- Press [Menu] key.

Display changes to "blinking of <on FS>", then span test starts.

On completion of the span test, the display automatically changes to <INSTRUMENTAL ER> and the instrumental error of the scale is displayed.

- Press [4] key.

<632 EX SPAN TEST> is displayed.

- Unload the weight from the weighing pan.

### 4 Exit the setting menu.

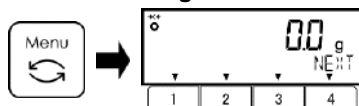

- Press [Menu] key to shift to the measuring mode.

### 8-4-1(3) Semi-Automatic Span adjustment with internal weight

**Note**

Do not power-off the scale while this function is operating.

**Reference**

- (1) This function is available only on models with internal calibration device.
- (2) Free key <<ICAL>> (span adjustment with internal weight) is assigned to <<F1>> on the models with internal calibration weight.

#### 1 Select the span adjustment with internal weight.

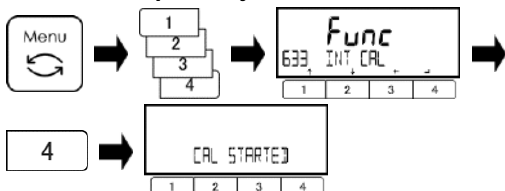

- Press [Menu] key, then press [1]-[4] keys to go to <633 INT CAL>.

- Press [4] key to execute.

#### 2 The span adjustment starts.

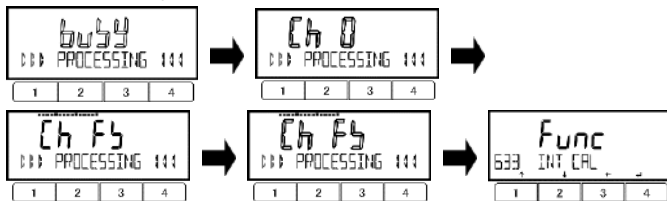

Display changes to the order of "blinking of <buSY>" → "blinking of <Ch 0>" → <Ch FS> → "blinking of <Ch FS>" → <633 INT CAL>.

#### 3 Exit the setting menu.

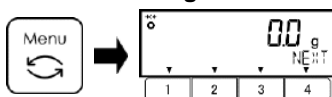

- Press [Menu] key to shift to the measuring mode.

### 8-4-1(4) Span test with internal weight

**Note**

Do not power-off the scale while this function is operating.

**Reference**

This function is available only on models with internal calibration device.

#### 1 Select the span test with internal weight.

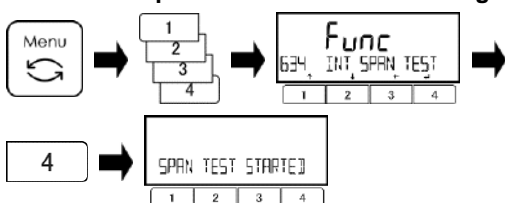

- Press [Menu] key, then press [1]-[4] keys to go to <634 INT SPAN TEST>.

- Press [4] key to execute.

#### 2 The span test starts.

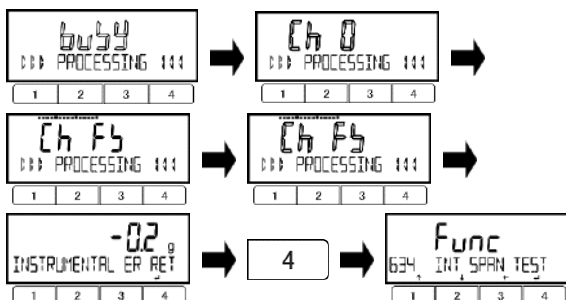

Display changes to the order of "blinking of <buSY>" → "blinking of <Ch 0>" → <Ch FS> → "blinking of <Ch FS>" → <INSTRUMENTAL ER> and the instrumental error of the scale is displayed.

- Press [4] key.

<634 INT SPAN TEST> is displayed.

#### 3 Exit the setting menu.

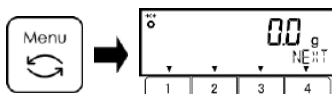

- Press [Menu] key to shift to the measuring mode.

## 8-4-2 Calibrating the internal weight

Use this function to calibrate the internal weight by external weight.



This function is unavailable for verified scale.

### Note

- (1) To calibrate more accurately, use a weight that is equivalent to the weighing capacity (Max).
- (2) An external weight used for the span adjustment shall be the one equivalent to:
  - OIML class F1 or higher for models with capacity of 33 kg and 62 kg;
  - OIML class F2 or higher for models with capacity 17 kg and 22 kg.
- (3) The calibrating the internal weight significantly affects the weighing accuracy. Please read this procedure carefully before getting to the adjustment.
- (4) Do not power-off the scale while this function is operating.

### Reference

This function is available only on models with internal calibration device.

### 1 Select the calibration of the internal weight.

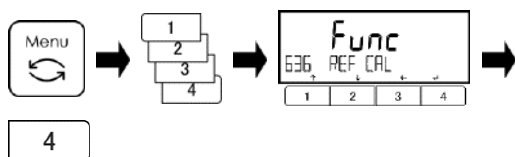

- Press [Menu] key, then press [1]-[4] keys to go to <636 REF CAL>.
- Press [4] key to execute.

### 2 Zero-point adjustment starts.

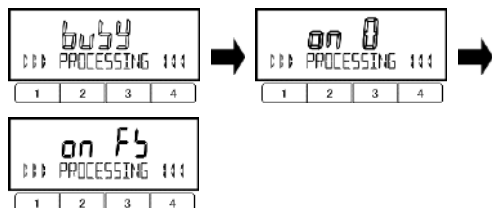

- Display changes to the order of "blinking of <buSY>" → "blinking of <on 0>".
- On completion of the zero-point adjustment, the display automatically changes to <on FS>.

### 3 The span adjustment starts. For HJ17K0.1S(R) and HJ22K0.1S(R):

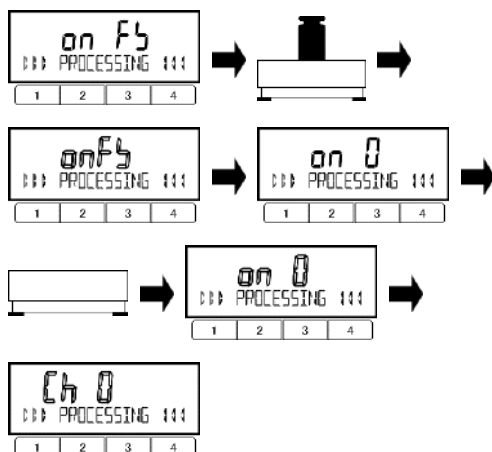

- Place the weight in the centre of the weighing pan.
- For HJ17K0.1S(R) and HJ22K0.1S(R):
  - Display changes to the order of <on FS> → "blinking of <on FS>".
  - Then span adjustment starts.

**For HJ33K0.1S(R), and HJ62K0.1DS(R):**

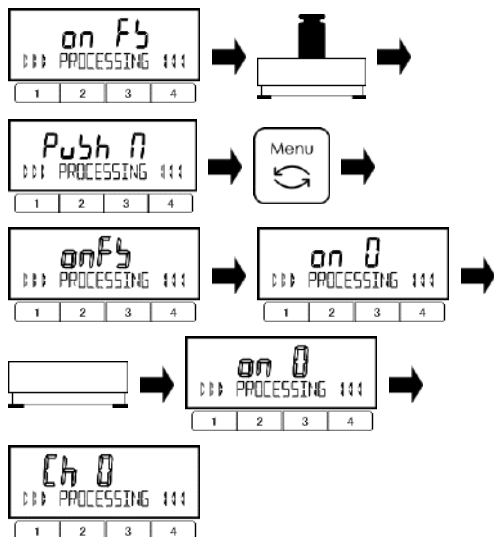

- For HJ33K0.1S(R), and HJ62K0.1DS(R):  
 Display changes to the order of  
 <on FS> → <push M>.  
 - Press [Menu] key.  
 Display changes to “blinking of  
 <on FS>”, then span adjustment starts.

On completion of the span adjustment, the display automatically changes to <on 0>.  
 - Unload the weight from the weighing pan.  
 Display automatically changes to “blinking of <on 0>” and zero-point adjustment starts.  
 On completion of the zero-point adjustment, the display automatically changes to “blinking of <Ch 0>”.

**4 The calibrating the internal weight starts.**

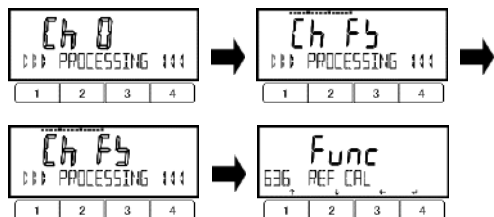

Display changes to the order of  
 “blinking of <Ch 0>” → <Ch FS> →  
 “blinking of <Ch FS>”.  
 On completion of the calibrating the internal weight, the display automatically changes to <636 REF CAL>.

**5 Exit the setting menu.**

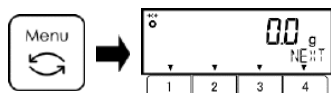

- Press [Menu] key to shift to the measuring mode.

## 8-4-3 Restore the internal weight calibration value to default



This function is unavailable for verified scale.

### Reference

This function is available only on models with internal calibration device.

### 1 Select the restore.

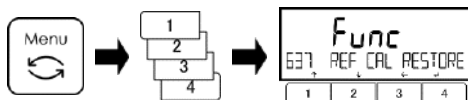

- Press [Menu] key, then press [1]-[4] keys to go to <637 REF CAL RESTORE>.

### 2 Execute the restore.

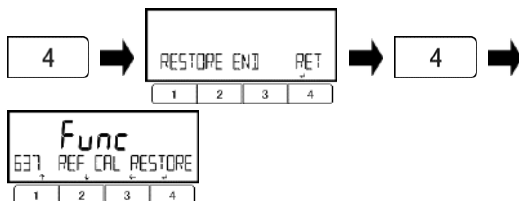

- Press [4] key to execute.

The internal weight calibration value is restored to default (factory setting).

- Press [4] key.

<637 REF CAL RESTORE> is displayed.

### 3 Exit the setting menu.

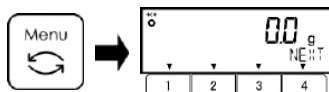

- Press [Menu] key to shift to the measuring mode.

### Note

For accurate calibration, please execute calibration of internal weight by referring "8-4-2 Calibrating the internal weight"

## 8-4-4 Advice CAL

The scale generates an alarm when calibration is needed.



This function is unavailable for verified scale.

### 1 Select the Advice CAL.

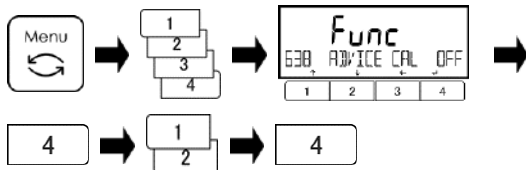

- Press [Menu] key, then press [1]-[4] keys to go to <638 Advice CAL >, and then press [4] key to change the setting.

- Press [1]/[2] key to select <NTF>.

OFF: Disable

NTF: Advice CAL

- Press [4] key to fix.

### 2 Exit the setting menu.

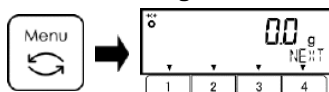

- Press [Menu] key to shift to the measuring mode.

### 3 Message appears when span adjustment is needed.

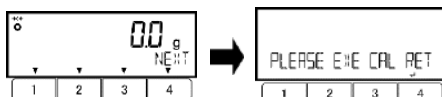

A message appears when time passed since power-on or last span adjustment, or temperature / atmospheric pressure changed.

### 4 Return to the weighing mode and execute span adjustment.

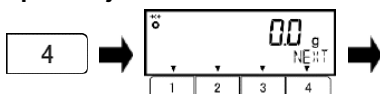

- Press [4] key to shift to the measuring mode.

- Then execute span adjustment with external weight (8-4-1(1)) or semi-automatic span adjustment with internal weight (8-4-1(3)).

8-4-1 (1) Span adjustment with external weight

or

8-4-1 (3) Semi-automatic span adjustment with internal weight

## 8-5 Scale control setting

### 8-5-1 Scale ID setting

A scale ID can be set to discriminate the scale. The scale ID is output with GLP header output and external span calibration/test result output. Scale ID is checked by free key <<ID>>.

#### 1 Select the scale ID setting.

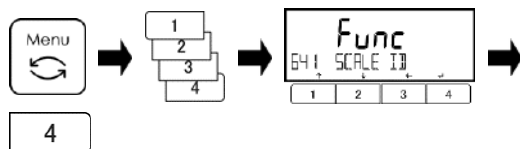

- Press [Menu] key, then press [1]-[4] keys to go to <641 SCALE ID>.
- Press [4] key.

#### 2 Input the scale ID.

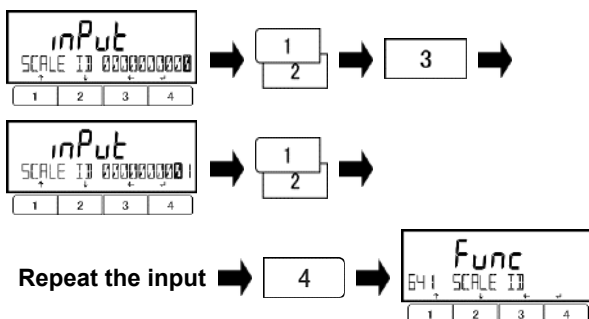

- The digit for inputting is blinking.
- Press [1]/[2] key to increment/decrement the digit to select.
- Press [3] key to input the next digit.
- Press [1]/[2] key.
- Repeat the input by the procedure above.
- Press [4] key to fix the scale ID and shift to <641 SCALE ID>.

#### 3 Exit the setting menu.

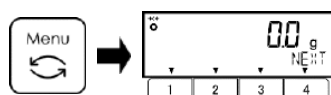

- Press [Menu] key to shift to the measuring mode.

### 8-5-2 Password control

Enable/disable the password protection.

#### Reference

- (1) Refer to "8-5-2 Administrator password registration" and "8-5-3 User password registration" for password registration/changing.
- (2) Refer to "Appendix 5 Scale operation with password control function" for using the scale with password control.

#### 1 Enable/disable the password protection.

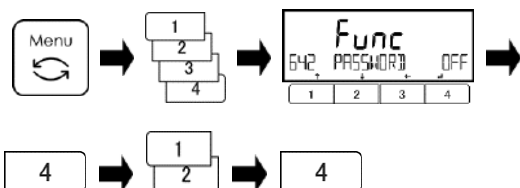

- Press [Menu] key, then press [1]-[4] keys to go to <642 PASSWORD>.
- Press [4] key to change.
- Press [1]/[2] keys to select;  
OFF : Disable  
ON : Enable
- Press [4] key to fix.

#### 2 Exit the setting menu.

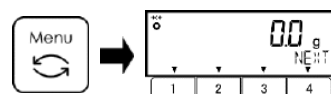

- Press [Menu] key to shift to the measuring mode.
- Password input display appears from next power on.

## 8-5-2 (1) Administrator password registration

### Note

- (1) Make sure not to forget the administrator password.
- (2) In case that the administrator password is lost, please contact the store where you purchased the product.

### Reference

Only one password can be set for administrator.

### 1 Select the Administrator password registration.

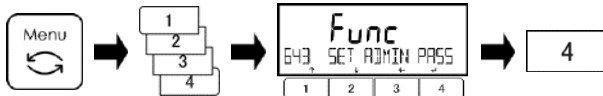

- Press [Menu] key, then press [1]-[4] keys to go to <643 SET ADMIN PASS>.
- Press [4] key to input the password.

### 2 Input the password to register.

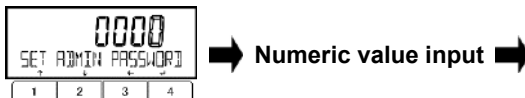

4

(Refer to "2-5-3 Numeric value input")

- Input to set the password.
- Four digits of 0-9 can be selected.
- Press [4] key to fix.

### 3 Exit the setting menu.

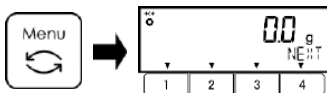

- Press [Menu] key to shift to the measuring mode.

## 8-5-2 (2) User password registration

Administrator can register the user password for each user (operator).

### Reference

- (1) Refer to "Appendix 5 Scale operation with password control function" for setting each user's authority.
- (2) Two users (User 1 and User 2) can be registered.
- (3) User 0 (guest) cannot be assigned a password.
- (4) This mode can be operated only when you log in in administrator mode with <642 PASSWORD> set to <ON>.

### 1 Select the User password registration.



- Press [Menu] key, then press [1]-[4] keys to go to <644 SET USER PASS>.
- Press [4] key to input the password.

### 2 Input the password to register.

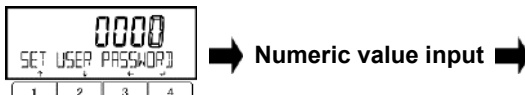

4

(Refer to "2-5-3 Numeric value input")

- Input to set the password.
- Four digits of 0-9 can be selected.
- Press [4] key to fix.

### 3 Exit the setting menu.

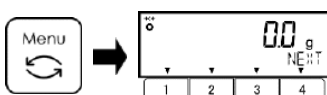

- Press [Menu] key to shift to the measuring mode.

### 8-5-3 Outputting of the span adjustment / test result

After span adjustment/test, the result can be output automatically.

#### Reference

Make sure to activate <41 RS232C> to output the data.

#### 1 Select the outputting.

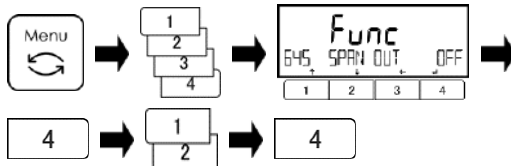

- Press [Menu] key, then press [1]-[4] keys to go to <645 SPAN OUT>.
- Press [4] key to change the setting menu.
- Press [1]/[2] key to select.
  - OFF: Disable
  - ON: Enable
- Press [4] key to fix.

#### 2 Exit the setting menu.

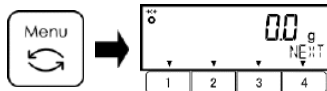

- Press [Menu] key to shift to the measuring mode.

### 8-5-4 Date indication format

Date indication format can be selected.

#### 1 Select the Date indication format.

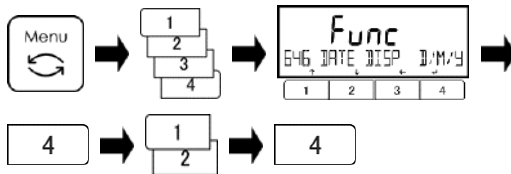

- Press [Menu] key, then press [1]-[4] keys to go to <646 DATE DISP>.
- Press [4] key to change the setting value.
- Press [1]/[2] key to select.
  - Y/M/D: Year, Month, Day
  - D/M/Y: Day, Month, Year
  - M/D/Y: Month, Day, Year
- Press [4] key to fix.

#### 2 Exit the setting menu.

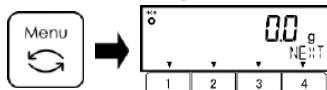

- Press [Menu] key to shift to the measuring mode.

### 8-5-5 Date setting

#### 1 Select the date setting.

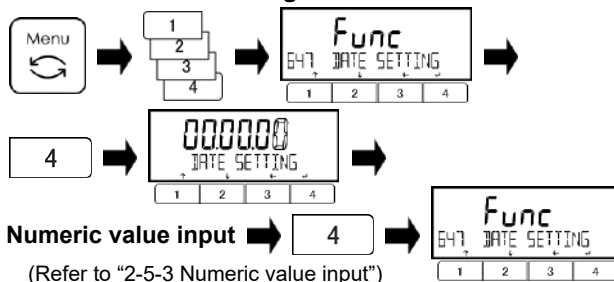

- Press [Menu] key, then press [1]-[4] keys to go to <647 DATE SETTING>.
- Press [4] key to change the setting value.
- The digit for inputting is blinking.
- Input the date.
- Press [4] key to fix the date setting.

#### 2 Exit the setting menu.

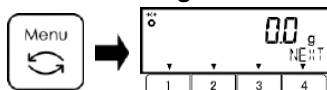

- Press [Menu] key to shift to the measuring mode.

#### 3 Indication of the date.

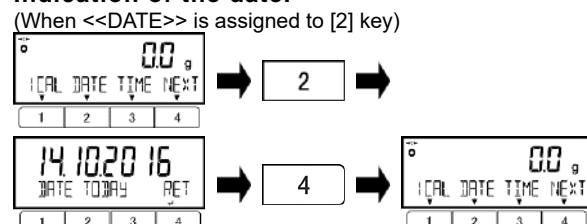

- Press [1]-[3] key of which the free key <<DATE>> is assigned.
- The date is indicated.
- Press [4] key to return to the measuring mode.



## 8-5-6 Time setting

### 1 Select the time setting.

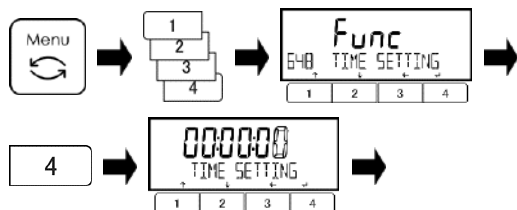

Numeric value input → 4 →



(Refer to "2-5-3 Numeric value input")

### 2 Exit the setting menu.

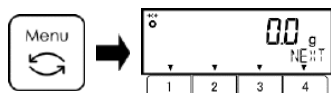

### 3 Indication of the time.

(When <<TIME>> is assigned to [3] key)

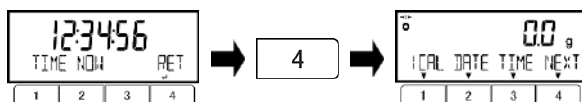

- Press [Menu] key, then press [1]-[4] keys to go to <648 TIME SETTING>.

- Press [4] key to change the setting menu.

The digit for inputting is blinking.

- Input the time.

- Press [4] key to fix the time setting.

- Press [Menu] key to shift to the measuring mode.

- Press [1]-[3] key of which the free key <<TIME>> is assigned.

The time is indicated.

- Press [4] key to return to the measuring mode.

## 8-5-7 Output language

Output language can be select from two languages; English or Japanese.

### 1 Select the language.

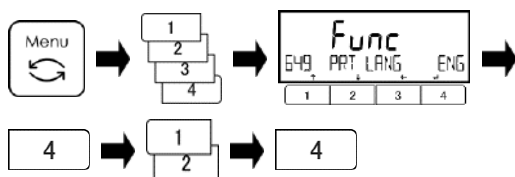

- Press [Menu] key, then press [1]-[4] keys to go to <649 PRT LANG>.

- Press [4] key to change the setting value.

- Press [1]/[2] key to select.

ENG: English

JPN: Japanese

- Press [4] key to fix.

### 2 Exit the setting menu.

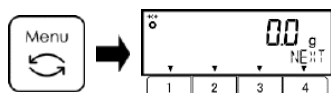

- Press [Menu] key to shift to the measuring mode.

#### Reference

Refer to "6 External input/output functions" for setting to communicate with other devices.

## 8-5-8 Readability Setting

The larger the readability becomes, the less the scale is affected by external influences. In addition, it takes less time for the scale reading to stabilize.

### Reference

- (1) Refer to "Appendix 1-1 Basic specifications" and "Appendix 4 Weighing capacity and readability by unit" for the default readability of each unit.
- (2) This function is not available on HJ62K0.1DS(R).

### 1 Select the readability setting.

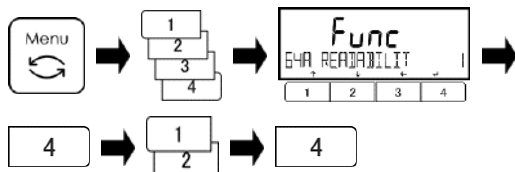

- Press [Menu] key, then press [1]-[4] keys to go to <64A READABILITY>.
- Press [4] key to change the setting value.
- Press [1]/[2] key to select.

		The default readability	
		1	5
Set value	1:	1(default)	5(default)
	2:	2	10
	5:	5	20
	10:	10	50

- Press [4] key to fix.

### 2 Exit the setting menu.

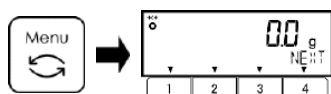

- Press [Menu] key to shift to the measuring mode.

## 8-5-9 Span adjustment with internal weight at power-on

### Reference

- (1) This function is available only on models with internal calibration device.
- (2) "Span adjustment with internal weight at power-on" operates first power-on after connection of AC adapter.

### 1 Select the span adjustment at power-on.

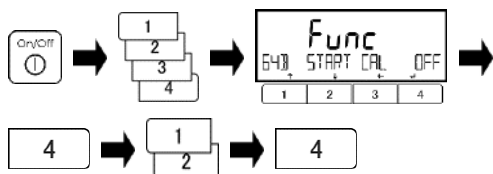

- Press [Menu] key, then press [1]-[4] keys to go to <64B START CAL>.
- Press [4] key to change the setting value.
- Press [1]/[2] key to select.
  - OFF: Disable
  - FORCE: Enable  
Always when the power is ON.
  - SELEC: Selectable  
Message is displayed.
- Press [4] key to fix.

### 2 Exit the setting menu.

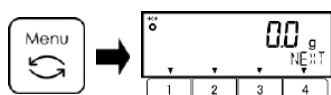

- Press [Menu] key to shift to the measuring mode.

### 3 Operate span adjustment at power-on.

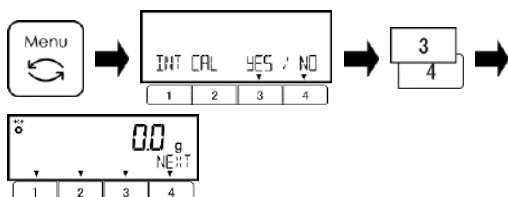

- Press [On/Off] key to turn on the scale.
- When <SELEC> is selected at step 1, select whether or not execute span adjustment by pressing [3]/[4] key.
  - YES: Execute
  - NO: Not execute
- The scale executes span adjustment by internal weight and then shifts to measuring mode.

### Note

Do not power-off the scale while span adjustment is operating.

## 8-5-10 Direct start setting

This is a function to turn on the scale automatically without pressing [On/Off] key when it is connected to the AC power. You can use this function when the scale is used in conjunction with other devices.

### 1 Select the direct start.

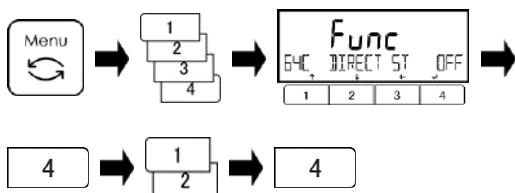

- Press [Menu] key, then press [1]-[4] keys to go to <64C DIRECT ST>.

- Press [4] key to change the setting value.

- Press [1]/[2] key to select.

OFF: Disable

ON: Enable

- Press [4] key to fix.

### 2 Exit the setting menu.

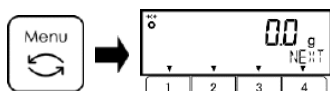

- Press [Menu] key to shift to the measuring mode.

## 8-5-11 Save tare weight function

When this function is activated, the last tare weight at the time the scale is powered off is recalled to tare-subtract when turning on the balance.

Use that function when you would like to prevent redoing the weighing operation due to an unexpected power failure in a place where the power supply is unstable.



This function is not available on verified scale.

### Reference

(1) Unlike its name "Save Tare Weight Function" or its displayed name <STORE TARE>, it is not a function that save the tare weight and keep it ready to be recalled at any time. When you would like to use the scale with such a function, please use "Preset tare" instead.

(2) When you use this function with "Span adjustment with internal weight at power-on" (<64B START CAL>), it is necessary to unload the measurement item and tare from the weighing pan before turning on the scale.

### 1 Select the save tare function.

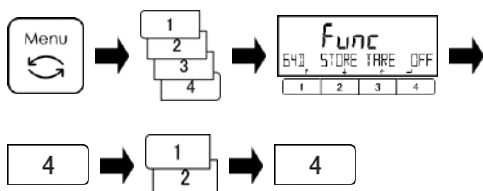

- Press [Menu] key, then press [1]-[4] keys to go to <64D STORE TARE>.

- Press [4] key to change the setting value.

- Press [1]/[2] key to select.

OFF: Disable

ON: Enable

- Press [4] key to fix.

### 2 Exit the setting menu.

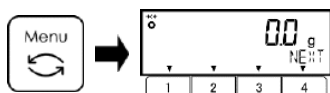

- Press [Menu] key to shift to the measuring mode.

### Note

Leaving the balance loaded for a long period may result in a larger error in weighing.

## 8-5-12 Initialise

This function is to initialise the scale to the factory settings except span adjustment, the date and time setting.

### 1 Select the initialise.

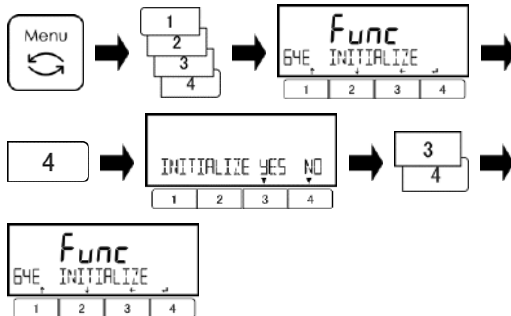

- Press [Menu] key, then press [1]-[4] keys to go to <64E INITIALIZE>.

- Press [4] key.

- Press [3]/[4] key to select.

NO: Cancel

YES: Execute

After initialisation is completed, <64E INITIALIZE> is displayed.

### 2 Exit the setting menu.

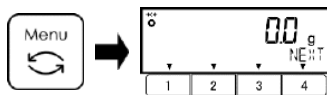

- Press [Menu] key to shift to the measuring mode.

# 9 Troubleshooting

**Reference**

If the trouble persists after following the procedures below, please contact the store you purchased.

## 9-1 Error message

Error Message/ Error Code	Cause	Coping method
OVER ERROR	<ul style="list-style-type: none"> <li>- The weight of the sample to be weighed is in excess of the maximum capacity.</li> <li>- The addition result has exceeded the maximum number of displayable digits.</li> </ul>	<ul style="list-style-type: none"> <li>- Split the sample into several pieces and weigh them.</li> <li>- Replace the tare with a lighter one.</li> <li>- Clear the calculation result, and then re-execute the addition/computation while being careful of the display digit.</li> </ul>
UNDER ERROR	The negative load is below the lower limit.	<ul style="list-style-type: none"> <li>- Improper setting of the weighing pan or pan base is suspected.</li> <li>- Check for contact with other object. Use the dedicated weighing pan and pan base only.</li> </ul>
DISPLAY ERROR	The addition result has exceeded the maximum display digit.	Clear the calculation result, and then re-execute the addition/computation while being careful of the display digit.
LOWER ERROR	The unit/reference weight in Counting/Percentage mode is below the lower limit.	Choose the samples of which unit weight/reference weight is larger than the lower limit.
ERR001 to ERR099	System error	Record the error code and notify the store where you purchased the product.
ERR703	<ul style="list-style-type: none"> <li>- The operation key was pressed at the time of starting from the standby status. If the error message is displayed nevertheless the operation key wasn't pressed, there is something wrong with the hardware.</li> </ul>	Do not press the operation key while the scale is in the process of starting from the standby status.
ERR705	Initial zero adjustment error. The initial zero adjustment was not completed in the process of starting from the standby status because of the unstable load.	<ul style="list-style-type: none"> <li>- Improper setting of the weighing pan or pan base is suspected.</li> <li>- Check for contact with other object.</li> <li>- Check for any wind or vibration.</li> </ul>
ERR706	The load is out of the initial zero adjustment range.	- Do not put any load on the weighing pan at the power-on of the scale.
ERR709 ERR710 ERR711	<ul style="list-style-type: none"> <li>- The load is unstable at the zero adjustment/tare subtraction.</li> <li>- Span adjustment time-out error.</li> </ul>	<ul style="list-style-type: none"> <li>- Improper setting of the weighing pan or pan base is suspected.</li> <li>- Check for contact with other object.</li> <li>- Check for any wind or vibration.</li> </ul>
ERR717	The mass of the external calibration weight is more than 1% differ from: <ul style="list-style-type: none"> <li>- the designated mass at the span adjustment; or</li> <li>- the maximum capacity (Max) at the span test.</li> </ul>	Check the calibration value of the weight and use the proper calibration weight.
ERR718	The mass of the calibration weight is under 50% of the maximum capacity at "span adjustment" or "calibration of the internal weight" by external calibration weight.	Use the calibration weight of which weight is equal to the maximum capacity.
ERR719	The adjust value by "span adjustment" is over 1% of the maximum capacity.	<ul style="list-style-type: none"> <li>- Execute &lt;637 REF CAL RESTORE&gt;, then execute &lt;636 REF CAL&gt;.</li> <li>- Check the mass of the weight used for the span adjustment by external weight.</li> </ul>
ERR722	- Tare key is pressed during the Preset tare operation.	Do not press the Tare key during the Preset tare operation.
ERR723	Out of Zero adjustment range (1.5% of the maximum capacity)	Make sure nothing on the weighing pan while executing zero adjustment.
ERR724	Out of Tare subtraction range (0g to the maximum capacity)	Chose the tare of which weight is within the tare subtraction range.

Error Message/ Error Code	Cause	Coping method
ERR734	Weight of the sample is out of the importing range at actual value setting method at Percent weighing mode (lower limit to maximum capacity).	Load the sample of which weight is within the importing range.
ERR735	Time-out error of importing the sample weight in the actual value setting method at Percent weighing mode.	- Improper setting of the weighing pan or pan base is suspected. - Check for contact with other object. - Check for any wind or vibration.
ERR736	The setting value is out of the setting range at numeric value setting method at Percent weighing mode (lower limit to maximum capacity).	Set the value within the range.
ERR739	Time-out error of importing the sample weight in the actual value setting method at Preset tare setting.	- Improper setting of the weighing pan or pan base is suspected. - Check for contact with other object. - Check for any wind or vibration.
ERR740	The setting value is out of the setting range at numeric value setting method or actual value setting method at Preset tare setting (0g to maximum capacity).	Set the tare of which weight is within the tare subtraction range.
ERR741	<631 EX CAL> is executed while the external span adjustment function is disabled.	Contact the store where you purchased the product.
ERR742	Internal span adjustment device is out of working order.	Contact the store where you purchased the product.
ERR743	Battery power supply is lacking to execute <633 INT CAL> or <634 INT SPAN TEST> or <636 REF CAL> (Internal rechargeable battery option).	- Recharge the battery. - Connect to the AC adapter.
ERR746	Invalid date or time was input at <647 DATE SETTING> or <648 TIME SETTING>.	Set the date and time correctly.
ERR747	Time-out error of importing the sample weight in the actual value setting method at Comparator function.	- Improper setting of the weighing pan or pan base is suspected. - Check for contact with other object. - Check for any wind or vibration.
ERR748	The setting value is out of the setting range at numeric value setting method or actual value setting method at Comparator mode ("0 – maximum capacity" to "maximum capacity").	Set the value within the range.
ERR749	Time-out error of importing the sample weight in the actual value setting method at Adding function.	- Improper setting of the weighing pan or pan base is suspected. - Check for contact with other object. - Check for any wind or vibration.
ERR750	- Weight of the sample to add is out of the importing range ("0 – maximum capacity" to "maximum capacity"). - The total value has exceeded the maximum display digit.	- Choose the sample of which weight is within the importing range. - Clear the total value.
ERR751	The unit weight of the samples is lighter than the minimum interval of the scale at Counting mode.	Choose the samples of which unit weight is larger than the minimum interval of the scale.
ERR752	The unit weight of the samples is 0g and under at Counting mode.	- Choose the samples of which unit weight is larger than the minimum interval of the scale. Counting mode cannot operate subtractive counting.
ERR753	Time-out error of importing the unit weight at Counting mode.	- Improper setting of the weighing pan or pan base is suspected. - Check for contact with other object. - Check for any wind or vibration.
ERR760	Adding operation is executed while the Adding function is disabled.	Set <141 ACTIVATE> ON then execute the adding operation.
ERR761	An error occurred at <636 REF CAL>.	Re-execute <636 REF CAL>.
ERR764	External weight used for <631 EX CAL> is different from the selected weight range at <SELECT WEIGHT>.	Use the external weight of which weight is within the selected range.

# 10 How to clean the scale



## CAUTION

Take care not to wet the AC adapter.

## Note

(1) Do not use items such as chemical agents or solvents for the switch panel or other resin components.

(2) Do not dismount the pan base.

(3) Take care not to apply excess force or impact to the scale.

- 1** Turn the power off, disconnect the AC adapter and close the AC adapter jack with the rubber cap, disconnect RS232 cables and close the D-sub9p connector with cover.

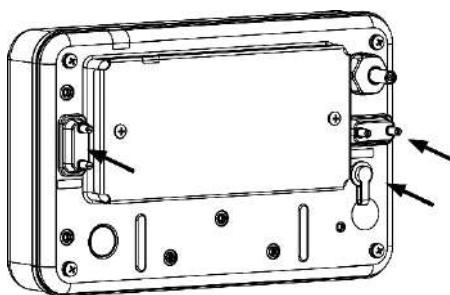

- 2** Remove the weighing pan.

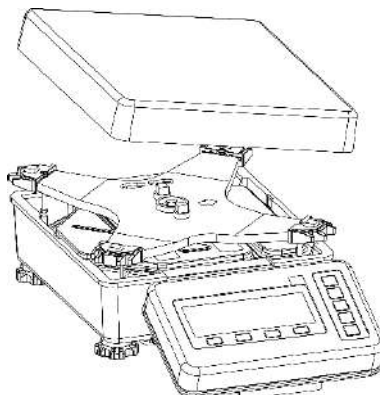

- 3** **Cleaning method**

(1) Wipe dirt with dry and soft cloth to the scale.

(2) When the dirt is heavy, clean them with a piece of wet cloth with neutral detergent then wash out with water.

(3) Thoroughly wiped off water with a dry cloth.

## Note

Spilled liquids remained on pan base and pan will affect the weighing accuracy.

# Appendix

## Appendix 1 Specifications

### Appendix 1-1 Basic Specifications

For non Legal  
Metrology

Model	Span adjustment	Max	d		Counting Mode minimum unit weight	Percentage mode minimum reference weight
HJ17K0.1S	External	17000 g	0.1 g		0.1 g	10 g
HJ17K0.1SR	Internal and External	17 kg	0.0001 kg		0.0001 kg	0.01 kg
		85000 ct	0.5 ct		0.5 ct	50 ct
HJ22K0.1S	External	22000 g	0.1 g		0.1 g	10 g
HJ22K0.1SR	Internal and External	22 kg	0.0001 kg		0.0001 kg	0.01 kg
		110000 ct	0.5 ct		0.5 ct	50 ct
HJ33K0.1S	External	33000 g	0.1 g		0.1 g	10 g
HJ33K0.1SR	Internal and External	33 kg	0.0001 kg		0.0001 kg	0.01 kg
		165000 ct	0.5 ct		0.5 ct	50 ct
HJ62K0.1DS	External	62000 g	Up to 6200.9 g gross/ 31009 ct gross:	0.1 g 0.0001 kg	0.1 g 0.0001 kg	10 g 0.01 kg
HJ62K0.1DSR	Internal and External	62 kg 310000 ct	Over 6200.9 g gross/ 31009 ct gross:	1 g 0.001 kg 10 ct		



Model	Span adjustment	Max	Min	e	d	Accuracy Class	Counting Mode minimum unit weight	Percentage mode minimum reference weight
HJ17K0.1S	External	17000 g	5 g	1 g	0.1 g	II	0.1 g	10 g
HJ17K0.1SR	Internal and External	17 kg	0.005 kg	0.001 kg	0.0001 kg		0.0001 kg	0.01 kg
HJ22K0.1S	External	22000 g	5 g	1 g	0.1 g	II	0.1 g	10 g
HJ22K0.1SR	Internal and External	22 kg	0.005 kg	0.001 kg	0.0001 kg		0.0001 kg	0.01 kg
HJ33K0.1S	External	33000 g	5 g	1 g	0.1 g	II	0.1 g	10 g
HJ33K0.1SR	Internal and External	33 kg	0.005 kg	0.001 kg	0.0001 kg		0.0001 kg	0.01 kg
HJ62K0.1DS	External	62000 g	5 g	1 g	Up to 6200.9 g gross:	II	0.1 g 0.0001 kg 5 ct	100 g 0.1 kg
HJ62K0.1DSR	Internal and External	62 kg	0.005 kg	0.001 kg	Over 6200.9 g gross:		1 g 0.001 kg 5 ct	5000 ct

## Appendix 1-2 Functional specifications

Item	Description
Weighing system	Tuning-fork vibration method
Measuring mode	Weighing / Counting / Percentage / Multiplied by Coefficient
Function	<p>- Function related to the operation Comparator / Adding / Stability waiting / Bar graph / Backlight / Auto power-off / Simple SCS / Range mode</p> <p>- Function related to the performance Stability discrimination width / Response speed / Zero tracking</p> <p>- Preset tare and Comparator setting Preset tare / Weight/Percentage / Counting / Multiplied by Coefficient / Comparator</p> <p>- Functions related to the lock Total lock release / Key lock / Menu lock</p> <p>- Controlling and adjustment functions Shortcut / Free key / Span adjustment with external weight / Span test with external weight / semi- automatic span adjustment with internal weight / Span test with internal weight / Calibrating the internal weight / Internal weight restore / Advice CAL / Scale ID /Password / Span adjustment / test result output / Date / Time setting / Output language (English, Japanese) / Readability / Span adjustment at power on / Direct start / Initialise</p> <p>- Other functions which can be assigned to free keys Gross indication / Tare value indication / GLP footer, header output / Date indication / Time indication / Scale ID indication/Hold</p>
Display	<p>LCD with backlight</p> <p>7-segment:                   Maximum 8-digit/Segment height up to 16.5 mm</p> <p>16-segment:                Maximum 20-digit/Segment height up to 8.5 mm</p> <p>Bar graph:                 30 steps</p>
Tare device	<p>- Type: Subtractive tare (Tare reduces the weighing range for net loads)</p> <p>- Range: Over 0 g and up to the maximum capacity of the scale (Max)</p> <p>- Method:</p> <p>1) Actual weight subtraction with [Tare] key</p> <p>2) Preset tare (5 data can be stored)</p>
Zero adjustment	<p>1) Initial zero setting Range: 18% of the maximum capacity</p> <p>2) Semi-automatic zero setting with [Zero] key Range: 3% (-1.5% to +1.5%) of the maximum capacity</p>
Zero tracking	Provided (Can be disabled via setting)
Display when overloaded	When indication limit is exceeded, <OVER ERROR> is indicated. (See Appendix 1-1 "Basic Specification".)
Output	<p>RS-232C compliant output (D-sub9P Male connector)</p> <p>Serial output for peripherals (D-sub9P Male connector)</p>

Compatible printer	CBM-910II
Power	Dedicated AC adapter (100-240 VAC / 50-60 Hz)
Ratings	AC adapter jack: 12 VDC, 2.4 VA (Maximum power consumption)
Weight of the scale (NET)	Approximately 18 kg
EMC	Immunity: Industrial electromagnetic environment Emission: Class B
Pan size	400 mm x 350 mm
Operating condition	Temperature: 5-35°C
	Humidity: 80% RH or lower (no condensation)
	Pollution degree: 2
	Altitude: 2000 m or less above sea level
	Location of use: Indoor use only
Ingress Protection	IP65
Option	Relay output (factory option) *1, RS422 output (factory option) *1 *2, Extended scale cable 5 m / 10 m (factory option), Internal rechargeable battery (factory option) *1, Hook for hanging weighing, Pole kit  *1 Relay output, RS422 output and Internal rechargeable battery cannot be installed together. *2 When RS422 output is installed, the standard RS232C output is not available.

## Appendix 2 Dimensional outline drawing

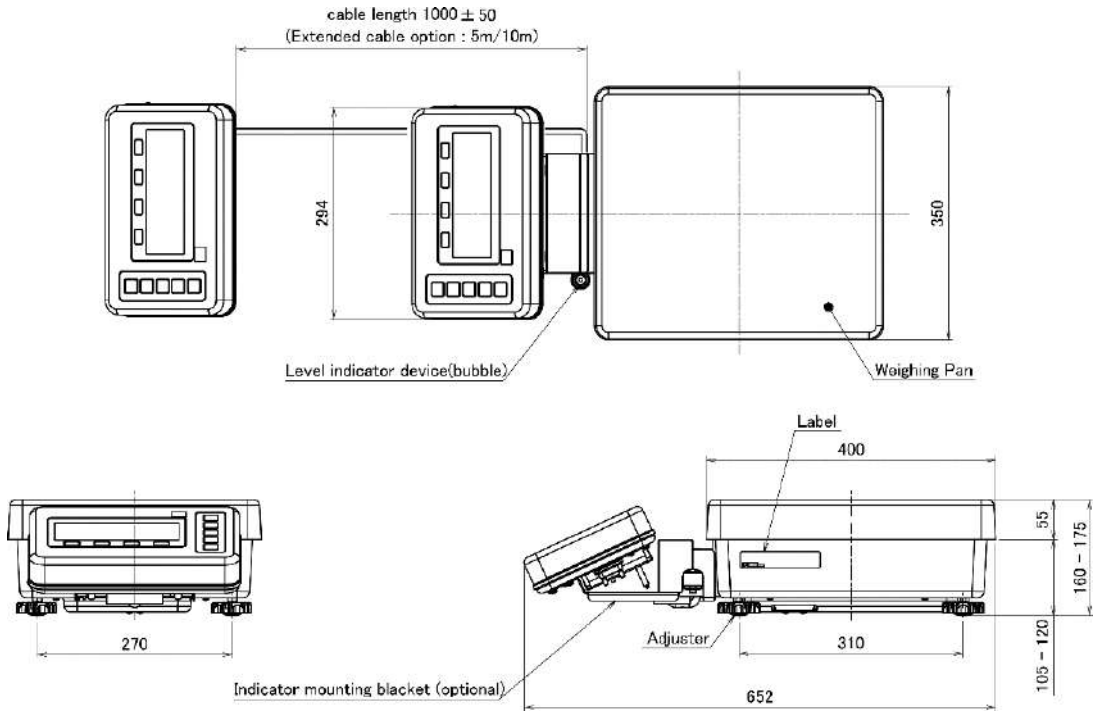

**Appendix 3 Unit conversion table**

Unit indication		Conversion coefficient
1 g	(gram)	1.00000000E+00
1 kg	(kilogram)	1.00000000E-03
1 ct	(carat)	5.00000000E+00
1 lb	(pound)	2.2046226E-03
1 oz	(ounce)	3.5273961E-02
1 oz t	(troy ounce)	3.2150746E-02
1 GN	(grain)	1.5432358E+01
1 dwt	(pennyweight)	6.4301493E-01
1 mom	(momme)	2.6666667E-01
1 MSG	(mesghal)	2.16999761E-01
1 t:H	(Hong Kong tael)	2.6717251E-02
1 t:S	(Singapore, Malaysia tael)	2.6455471E-02
1 t:T	(Taiwan tael)	2.6666667E-02
1 to	(tola)	8.5735324E-02
1 BA t	(baht)	6.59630607E-02

## Appendix 4 Weighing capacity and readability by non-metric units



These units are not available for verified scale.

Unit	Model			
	HJ17K0.1S(R)	HJ22K0.1S(R)	HJ33K0.1S(R)	HJ62K0.1DS(R)
<b>:b</b> pound	37 0.0005	48 0.0005	72 0.0005	Gross 13.009 / 130 0.01 / 0.1
<b>oz</b> ounce	590 0.005	770 0.005	1100 0.005	Gross 210.09 / 2100 0.01 / 0.1
<b>oz t</b> troy ounce	540 0.005	700 0.005	1000 0.005	Gross 190.09 / 1900 0.01 / 0.1
<b>dwt</b> pennyweight	10000 0.1	14000 0.1	21000 0.1	Gross 3900.9 / 39000 0.1 / 1
<b>mom</b> momme	4500 0.05	5800 0.05	8800 0.05	Gross 1600.9 / 16000 0.1 / 1
<b>t:H</b> Hong Kong tael	450 0.005	580 0.005	880 0.005	Gross 160.09 / 1600 0.01 / 0.1
<b>t:S</b> Singapore / Malaysia tael	440 0.005	580 0.005	870 0.005	Gross 160.09 / 1600 0.01 / 0.1
<b>t:T</b> Taiwan tael	450 0.005	580 0.005	880 0.005	Gross 160.09 / 1600 0.01 / 0.1
<b>to</b> tola	1400 0.01	1800 0.01	2800 0.01	Gross 530.09 / 5300 0.01 / 0.1

## Appendix 5 Scale operation with password control function

This chapter describes how to use the scale with “8-5-2 Password control”. This function is useful for setting different authority for each user/guest.

### Appendix 5-1 User’s authority setting

**1**

**Power on the scale.**

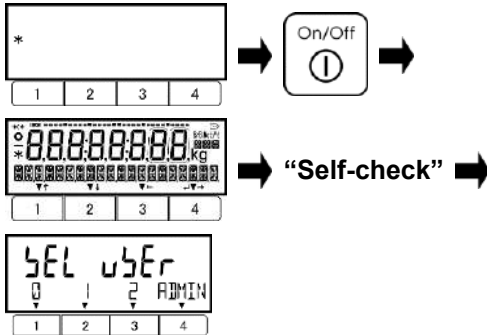

Enable the <642 PASSWORD> and register the administrator password in <643 SET ADMIN PASS>, then power-off the scale. Press [On/Off] key, then the scale shifts to User login mode after start-up operation.

**2**

**Go to the Administrator login mode.**

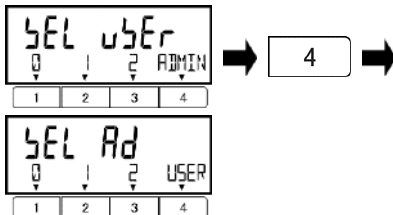

Press [4] key to go to “Administrator login mode”.

<SEL Ad > is indicated on the 7-segment display.

**3**

**Select the user to set the authority.**

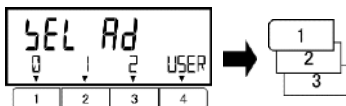

Select the user

0 : Guest user

1 : User 1

2 : User 2

USER : Shift to the User login mode

**4**

**Input the administrator password.**



Input the administrator password by pressing [1]-[4] keys.

Each digit increments as “0, 1, ..., 8, 9, 0” by pressing each functional key.

First digit from the left : [1] key

Second digit from the left : [2] key

Third digit from the left : [3] key

Fourth digit from the left : [4] key

**5**

**Start up the scale.**

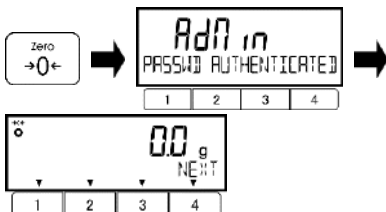

Press [Zero] key.

When the password is authenticated, the scale starts up.

**6**

**Register the user password.**

Refer to “8-5-2(2) User password registration”.

**Reference**

(1) The user password of which selected in Step 3 is registered.

(2) When “0: Guest user” is selected at step 3, skip this step.

# 7

## Set the functions and setting values which are intended to be fixed.

Refer to “3 Functions related to the operation”, “4 Functions related to the performance”, “5 Preset tare and Comparator setting”, “6 External input/output functions” and “8 Controlling and adjustment functions” to set functions/setting values to be fixed.

### Reference

<5 LOCK> and <6 ADMIN/ADJUST> are displayed only for the administrator.  
When to authorize each user to operate “Span adjustment with internal/external weight”, “Adding function”, etc., please assign the functions to <<F1>>-<<F6>> (Free key). (Refer to “8-3 Free key settings”.)

# 8

## Set the user’s authority (Lock setting).

Refer to “7 Functions related to the lock” to set user’s authority for key operation and/or accessing to setting menus.

## Appendix 5-2 User/guest login

# 1

### Power on the scale and go to the User login mode.

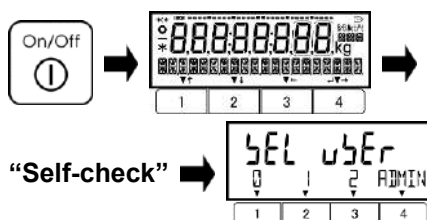

Press [On/Off] key, then the scale shifts to User login mode after start-up operation.

< SEL USER > is indicated on the 7-segment display.

# 2

### Select the user number.

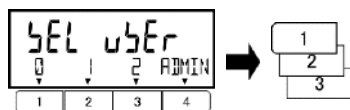

Select the user (operator) number;

- 0 : Guest user
- 1 : User 1
- 2 : User 2

ADMIN : Shift to the Administrator login mode

# 3

### Input the user password.



Input the user password by pressing [1]-[4] keys.

Each digit increments as “0, 1, ..., 8, 9, 0” by pressing each functional key.

- First digit from the left : [1] key
- Second digit from the left : [2] key
- Third digit from the left : [3] key
- Fourth digit from the left : [4] key

# 4

### Start up the scale.

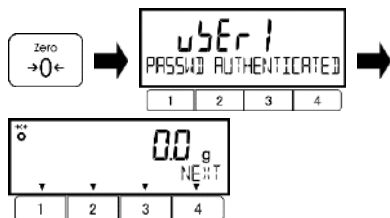

Press [Zero] key.

When the password is authenticated, the scale starts up.

# 5

### Use the scale with the user’s/guest’s authority.

Lock setting configured by administrator is reflected.

### Reference

When “0: Guest user” is selected at step 2, step 3 and 4 are skipped.



## Appendix 6 Operation with internal rechargeable battery

This function can only be used with a scale equipped with optional internal rechargeable battery (factory option).



Be sure to use the AC adapter supplied with the scale. A different AC adapter may cause the batteries to generate heat or explode.





### Reference

- (1) When you use the scale for the first time after you purchase it, battery operation time may be shorter than usual because of natural discharge.
- (2) If nothing is displayed or the display is turned off in a minute after you turn on the scale or the display is turned off after beep (PiPiPiPiPiPi) sound the battery may be weak recharge the battery or operate the scale on the AC adapter.
- (3) When changing to <  > mark, you cannot operate "Span adjustment with internal weight", "Span test with internal weight" and "Calibration of the internal weight". When you use those functions, please charge or use it with AC adapter.

## Appendix 6-1 Specifications of battery

Installation:	Factory option, built-in type
Type:	NiMH
Ratings:	6.0 V dc, 2100 mAh
Charge time:	About 12 hours
Operation time:	About 10 hours of continuous operation (backlit off)
Can be recharged:	More than 300 times

## Appendix 6-2 Recharging battery

A <  > icon is displayed when the scale is operated with battery. As the battery get weaker, the icon is changed from <  > to <  >. When the icon changes to <  > (flashing), follow the steps below to charge the battery.

- (1) Connect the AC adapter supplied with the scale.
- (2) Turn the scale off.
- (3) Wait about 12 hours until the battery is fully recharged.

